

IL GIALLO A FUMETTI - ANNO XL - N. 2

DIABOLIK

NOTTE MAGICA



#IORESTOACASA - letture gratuite

L. 3000
€ 1,55

IL GIALLO A FUMETTI
DIABOLIK

di A. e L. GIUSSANI

NOTTE MAGICA



#IORESTOACASA – letture gratuite

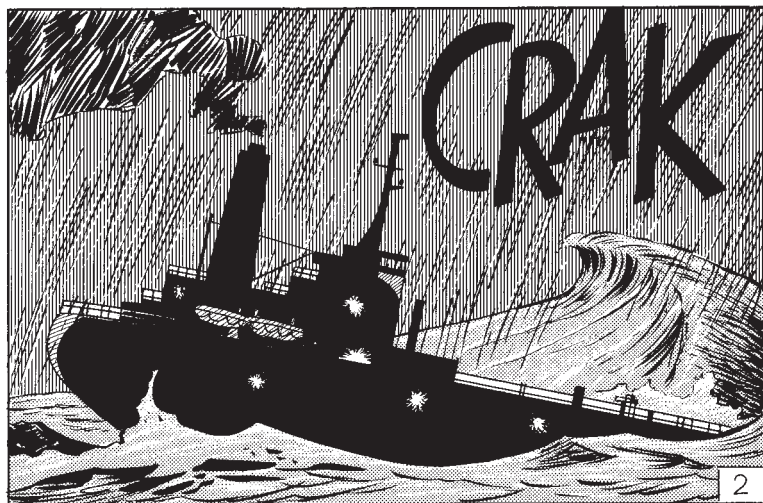

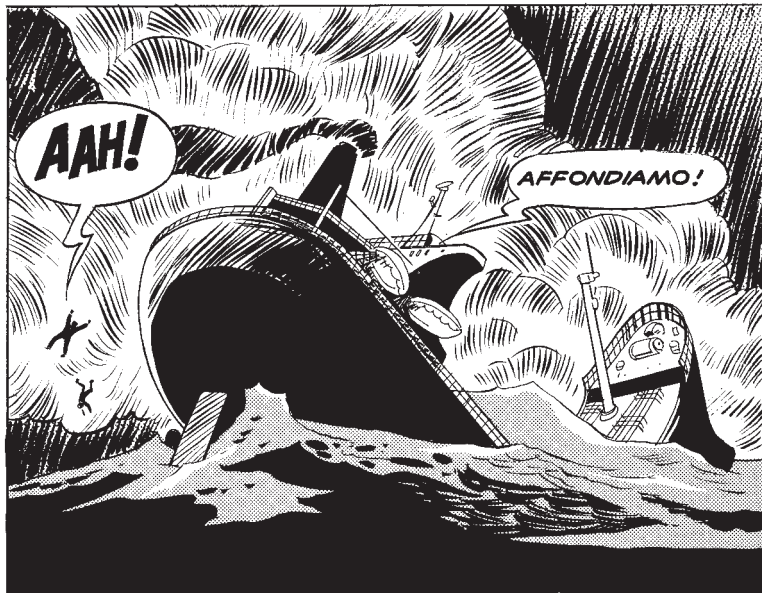





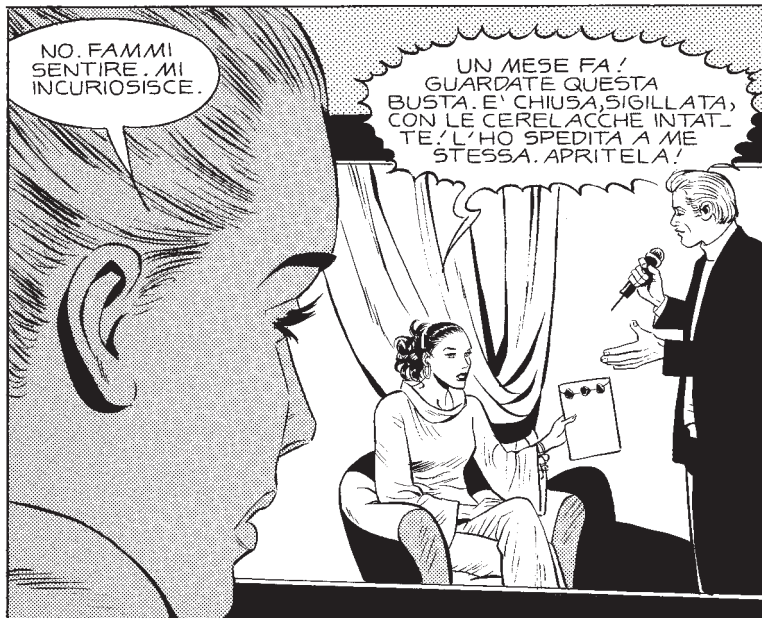

NO. FAMMI SENTIRE. MI INCURIOSISCE.

UN MESE FA!
GUARDATE QUESTA
BUSTA. E' CHIUSA, SIGILLATA,
CON LE CERELACCHE INTAT-
TE. L'HO SPEDITA A ME
STESSA. APRITELA!



CONTROLLATE
LA DATA.

E' VERO, E'
ESATTAMENTE
DI VENTI-
SETTE
GIORNI
FA.



AVEVO AVUTO
UNA PRE-
MONIZIONE.
UN TERRI-
BILE INCUBO,
NEL CORSO
DEL QUALE
AVEVO VI-
STO DISTIN-
TAMENTE
IL DISASTRO.
E HO FATTO
QUESTO DISE-
GNO. LE MIE
MANI SI
MUOVEVANO
DA SOLE. UNA
FORZA SUPE-
RIORE LE
GUIDAVA.







UNA SETTIMANA PIU' TARDI...

HO INDETTO QUESTA CONFERENZA STAMPA PER DIMOSTRARVI LE MIE FACOLTA' "ECCEZIONALI". GUARDATE BENE QUESTA BUSTA, CHIUSA, SIGILLATA, CON LA CERALACCA, COME LA PRECEDENTE. ORA VERRA' INSERITA IN UN'ALTRA BUSTA ANONIMA... MA...



...ECCO. IL TUTTO VERRA' INVIATO A UN NOTAIO CON ISTRUZIONI PRECISE. E SARA' APERTA SOLO DOPO IL PROSSIMO COLPO DI DIABOLIK.



QUALE NOTAIO? UN VOSTRO AMICO, SCOMMETTO.

BATTUTA INFELICE, CARO SIGNORE. NO. UN NOTAIO DI FAMA, AL DI SOPRA DI OGNI SOSPETTO. CONOSCERETE IL SUO NOME AL MOMENTO OPPORTUNO.







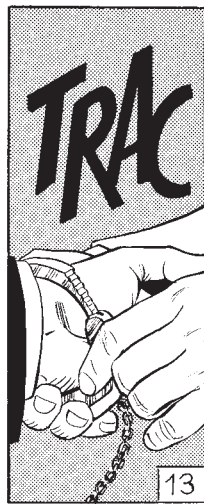

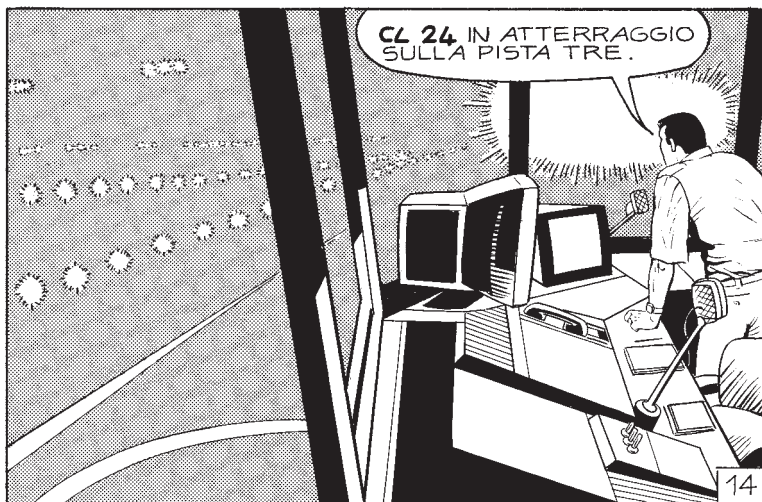

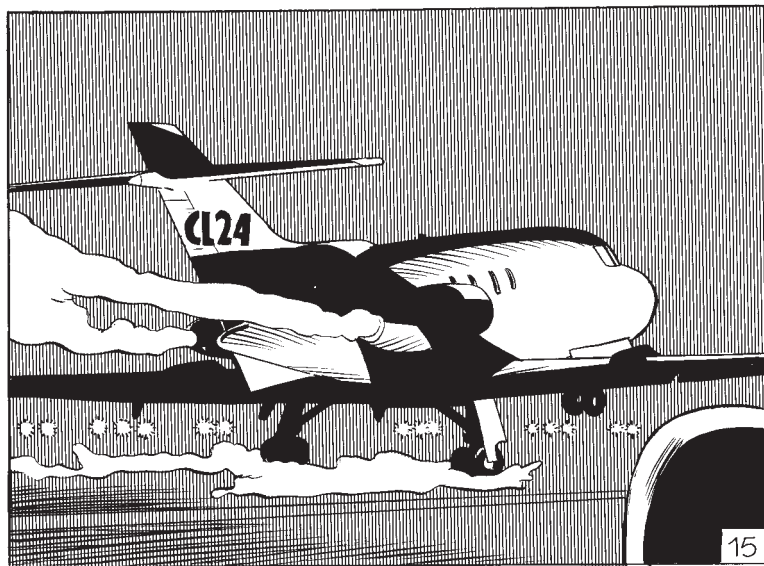

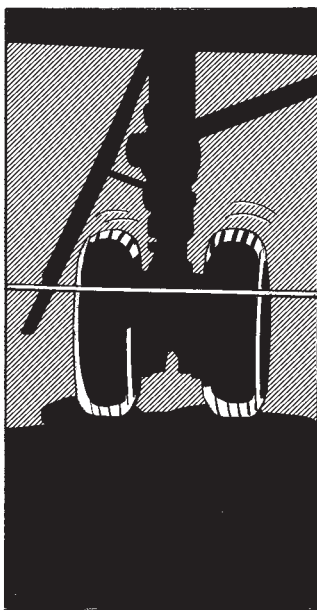
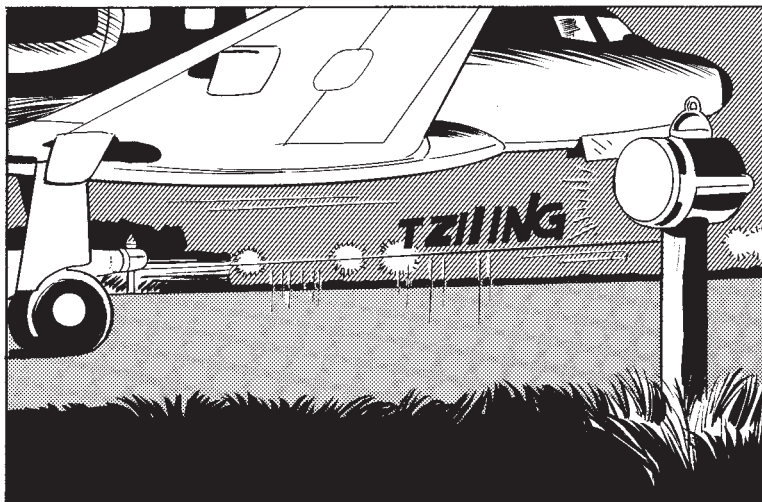

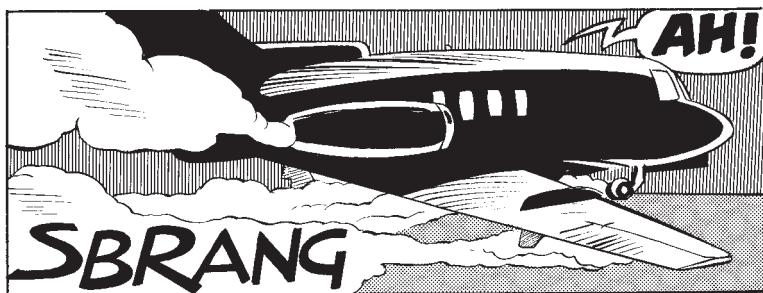
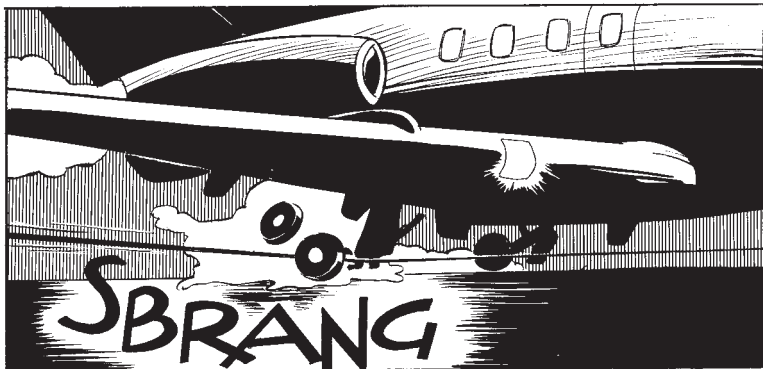





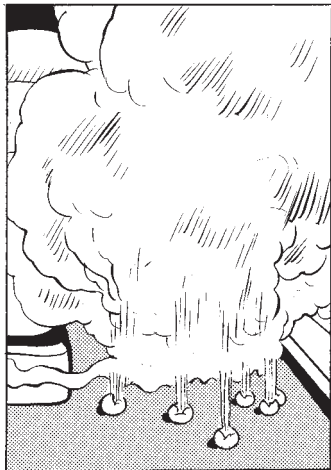





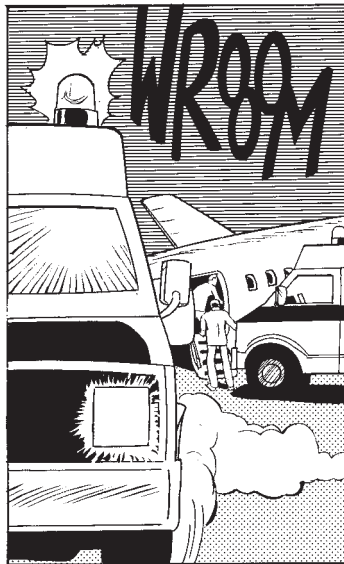

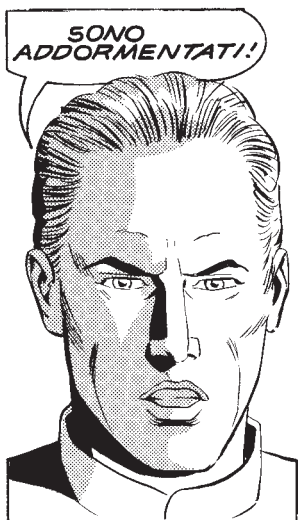

QUALCHE MINUTO DOPO...



PRESTO, PRESTO!
TRA POCO TUTTA
LA ZONA VERRA'
CIRCONDATA!

POVERACCIO...L' HAI TAL
MENTE "INSANGUINATO"
CON IL COLORANTE CHE
SEMBRA PROPRIO MALRI-
DOTTO.

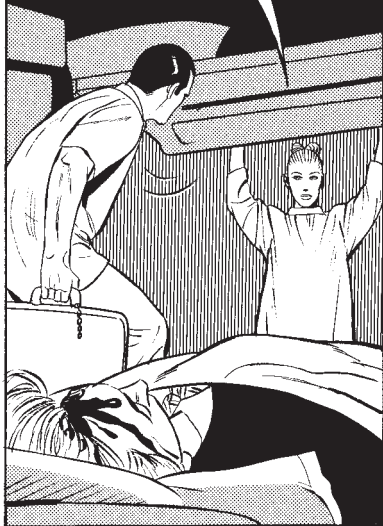

DORMIRA' ANCORA UN PAIO D' ORE.
POI STARA' BENISSIMO.



IL SIGNOR
VILLIERS INVECE ,
STARA' MOLTO
MENO BENE.





IGNORO I MOTIVI PER CUI SONO STATO CONVOCATO.
SO SOLTANTO CHE LA BUSTA NE CONTIENE UN'ALTRA,
SIGILLATA CON LA CERALACCA.

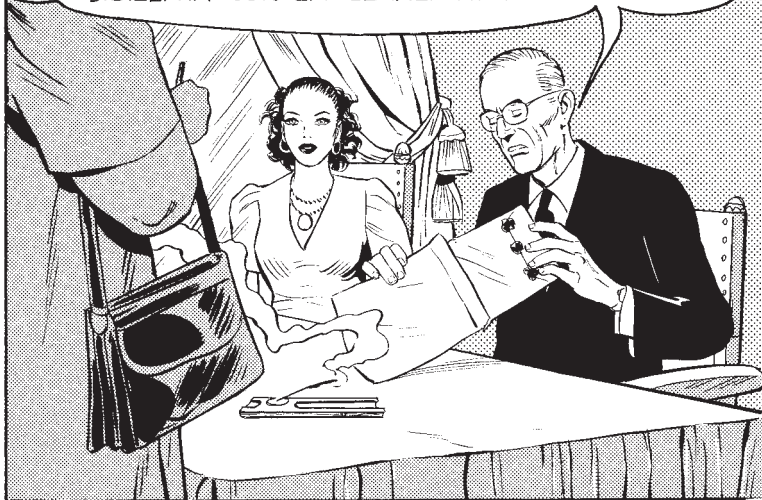

SONO IO IL CLIENTE CHE VI HA
MANDATO TUTTO CIÒ, APPUN-
TO VENTI GIORNI FA. VI
CHIEDO DI APRIRE
ANCHE LA SECONDA
BUSTA, SIGNOR
NOTAIO.



C'E' UN BREVE
TESTO, MANO-
SCRITTO.





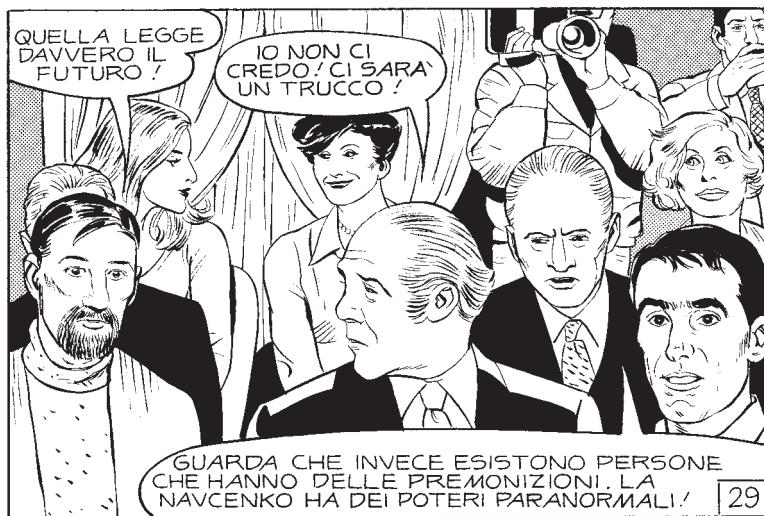

A L NOTIZIARIO DELLA SERA...

SCONVOLGENTI RIVELAZIONI DELLA
MAGA SIBILLA NAVCENKO. AVEVA
PREVISTO IL COLPO DI DIABOLIK
CON TRE SETTIMANE DI
ANTICIPO.

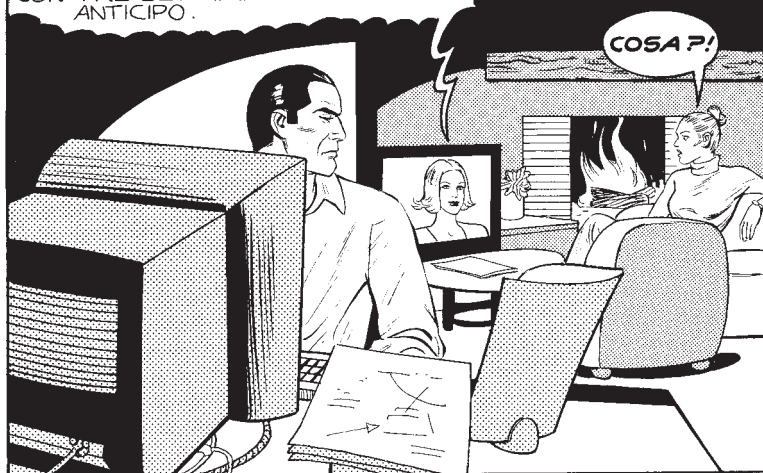

LA NAVCENKO STA
ENTRANDO ORA ALLA
CENTRALE DI POLIZIA.
CHE L'ISPETTORE
GINKO NE VOGLIA
SAPERE DI PIU' SU
QUESTA SIGNORA CHE
RIESCE A SAPERE LE
MOSSE DI DIABOLIK
PRIMA CHE AVVENGA...
NO ?









DUE MESI
DOPO...

SIBILLA, MIO
MARITO LASCERA'
QUELLA DONNA ?

CHIEDIAMO AI TAROC-
CHI. NON SBAGLIANO
MAI. PRENDETE UNA
CARTA.



IL SOLE ! MOLTO BENE !
E' UN OTTIMO SEGNO .
QUESTA CARTA INDICA
UN FUTURO FELICE .

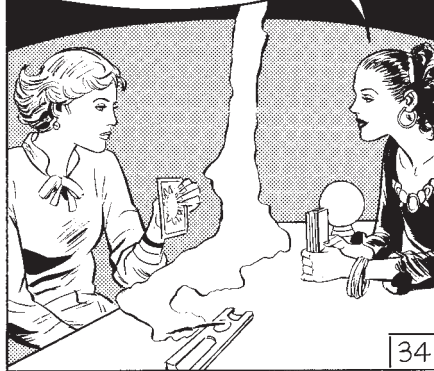

E IO POI SENTO... SENTO
COME UN FLUIDO BENEFICO
ATTORNO A VOI...



IO SENTO CHE VOI RIAC-
QUISTERETE LA SERE-
NITA'. E' COME UN'ONDA
POSITIVA CHE SI
TRASMETTE DA VOI A
ME... DA ME A VOI... UN
FLUSSO E RIFLUSSO
DI GIOIA...

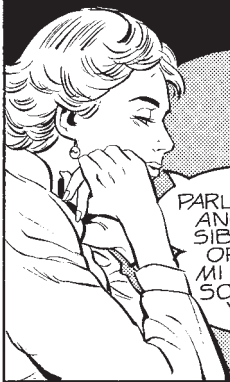

PARLATEMI
ANCORA,
SIBILLA,
ORMAI
MI FIDO
SOLO DI
VOI.

MEZZ'ORA PIU' TARDI...

SIBILLA, SONO
PREOCCUPATISSIMO,
SONO ANGOSCIATO!

CALMA. NON DOVETE
FARVI DOMINARE
DAGLI EVENTI. AL
CONTRARIO,
DOVETE VOI
DOMINARLI!



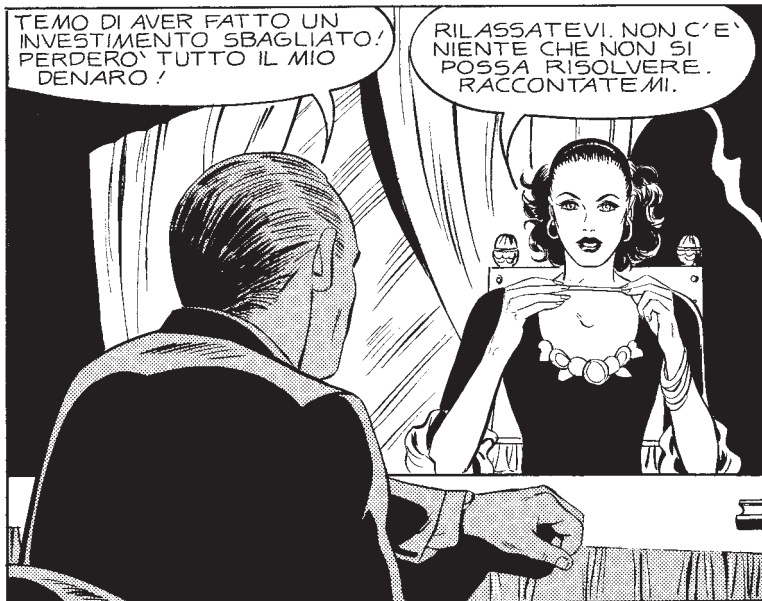

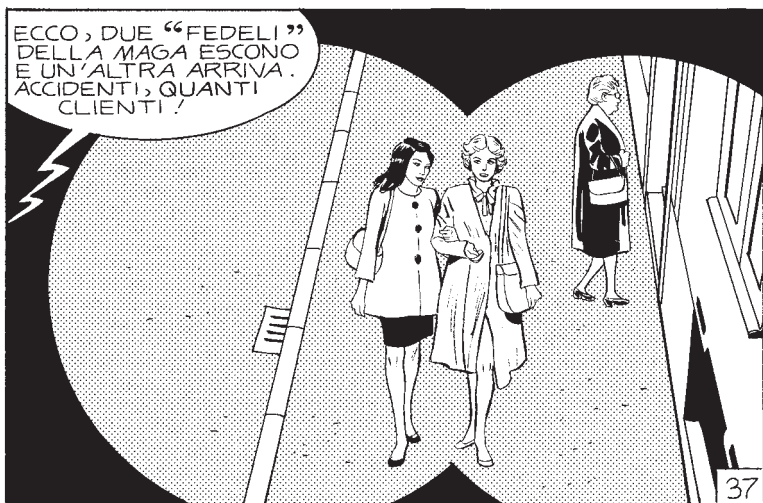
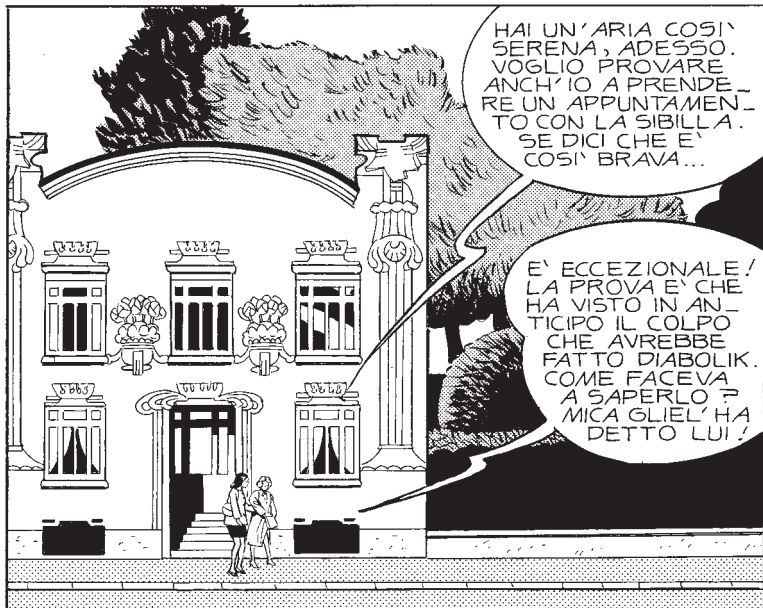

GIA'. SONO DUE MESI CHE TENIAMO D'OCCHIO LA CASA E I TELEFONI DELLA NAVCENKO: UN VIA VAI DI PERSONE CHE L'ADORANO! CHE PENDONO DALLE SUE LABBRA: UOMINI, DONNE, GIOVANI, VECCHI !



L'UNICA COSA CHE HANNO IN COMUNE E' LA RICCHEZZA. LE PARCELLE DI MADAME SIBILLA SONO SALATE. COMUNQUE, SE TROVA DEI POLLI CHE PAGANO PER SENTIRSI DIRE DA LEI COSA DEVONO FARE, FA BENE A SPENNARLI.

NON ESAGERARE. GUARDA CHE ESISTONO DELLE PERSONE CON FACOLTA' PARANORMALI !





DUE GIORNI DOPO...



GLI AGENTI IN BORGHESE
NON SONO PIU' VENUTI.
GINKO SI E' STANCATO DI
CONTROLLARE LA MAGA.
NON POTEVA CERTO TE-
NERLA SOTTO SORVEGLIANZA
PER TUTTA LA VITA. ORA
TOCCA A ME.

SE EVA SAPESSSE
CHE SONO QUI...
MA PROPRIO NON
GLIELO POTEVO
DIRE, DOPO AVER
SOSTENUTO MIL-
LE VOLTE CHE
QUESTA SIBILLA
E' UN'IMBRO-
GLIONA!



#IORESTOACASA - letture gratuite

MI AVREBBE PRESO IN GIRO A MORTE. D'ALTRA PARTE VOGLIO PROPRIO SCOPRIRE COME HA FATTO QUELLA DONNA A SAPERE CHE AVREI RUBATO QUEI DIAMANTI.

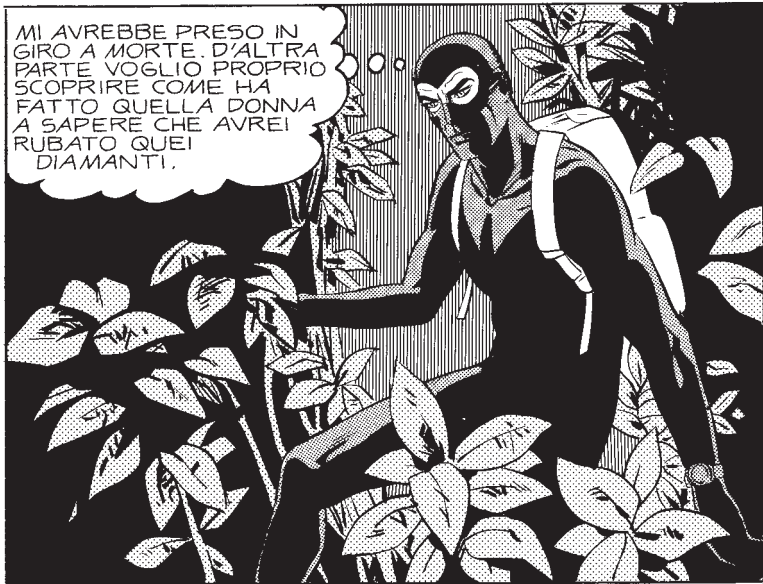

QUESTO STRUMENTO E' IN GRADO DI RILEVARE LA PRESENZA DI UN CAMPO MAGNETICO, CIOE' DI CONTATTI ELETTRICI.



POSITIVO.





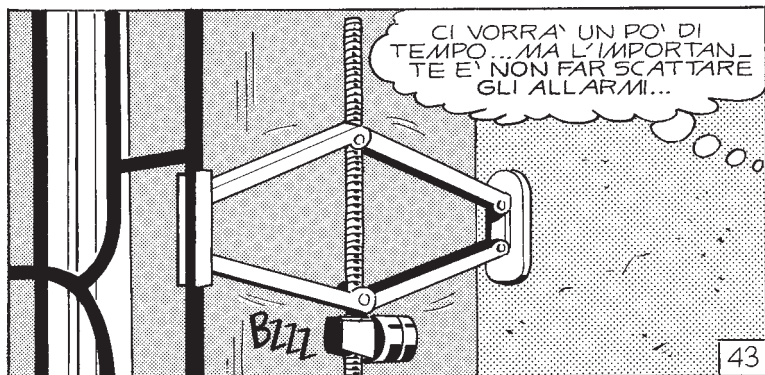
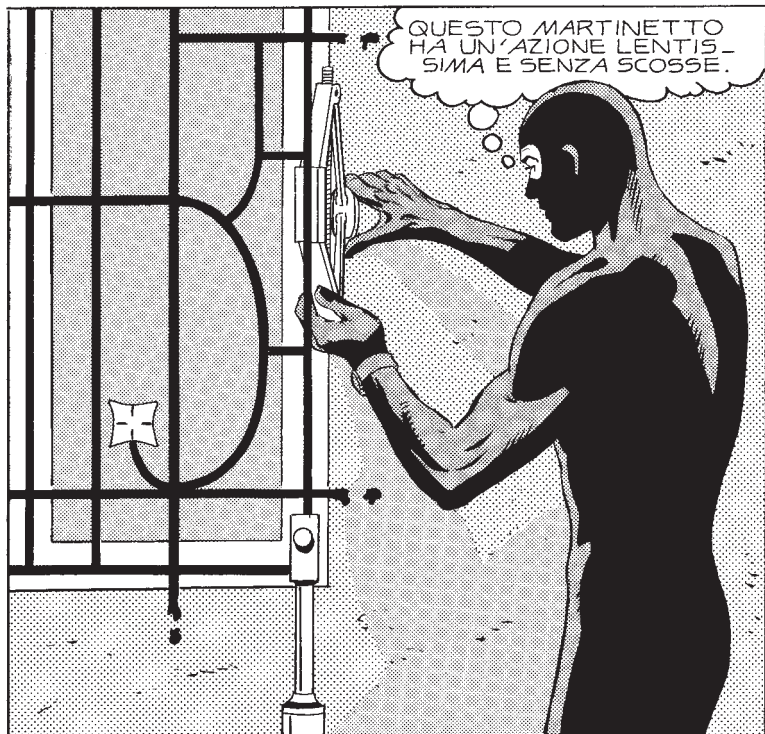

POCO PIU' TARDI...

ECCO... DOVREI
RIUSCIRE A PASSARE
SENZA TOCCARE
L'INFERRIATA...

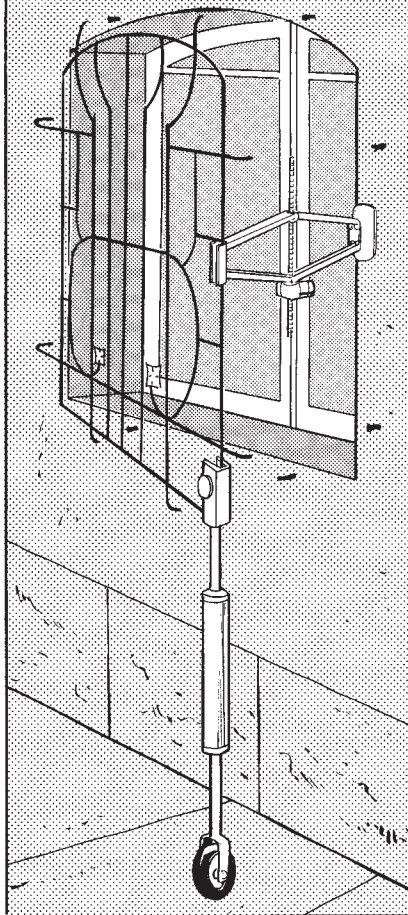

NON CI SONO
ALTRI SISTEMI DI
SICUREZZA...

zzz



ORA POSSO ENTRARE
SENZA PROBLEMI.

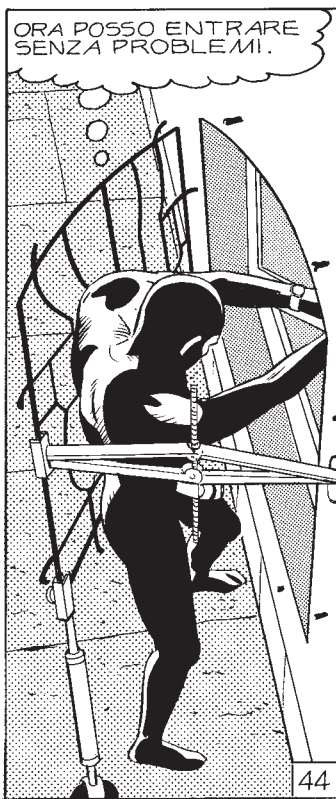

44

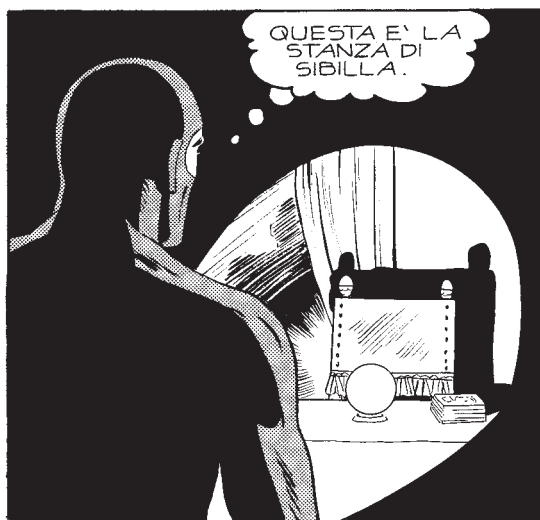
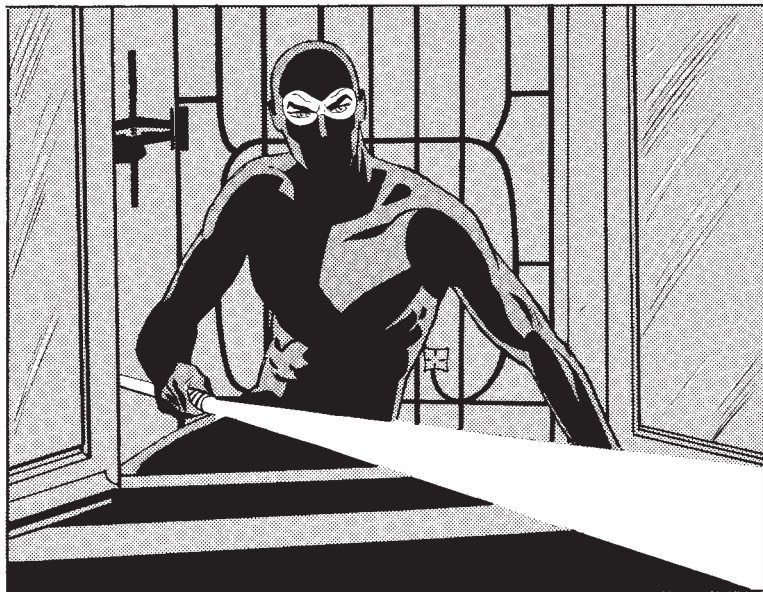











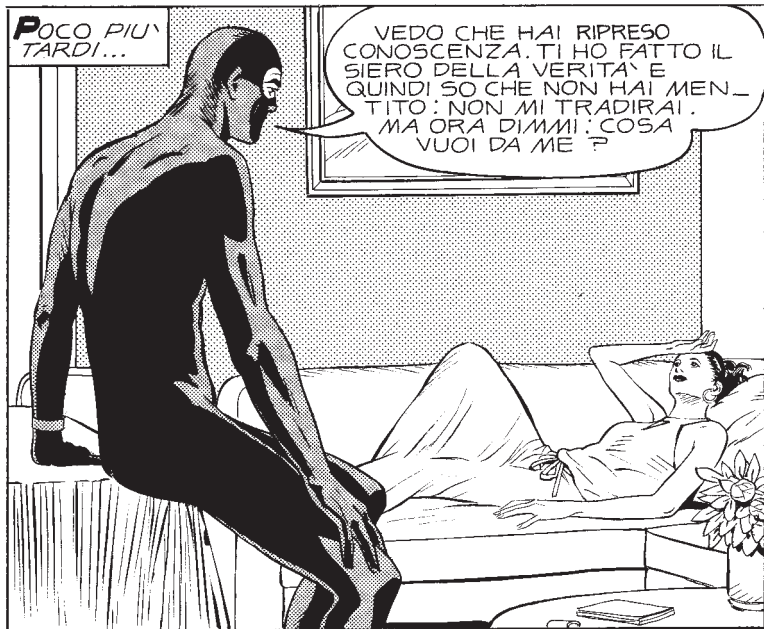





IO VOGLIO SOLO GUADAGNARE DEL DENARO. E NE STO GUADAGNANDO PARECCHIO. MA È SUCCESSO DI PIÙ: UNA MIA CLIENTE ERA TERROZZATA DAI FURTI, UNA VERA E PROPRIA FOBIA. ALLORA MI SONO PERMESSA DI DARLE QUALCHE CONSIGLIO SU COME TENERE AL SICURO LE SUE RICCHEZZE.



COMINCIO
A CAPIRE.

APPUNTO. ORA, A MOLTI
MIEI CLIENTI HO DATO
INDICAZIONI. E LORO, CHE
HANNO TOTALE FIDUCIA IN
ME, HANNO SEGUITO I
MIEI CONSIGLI. COSÌ
IO CONOSCO IL MODO
PER ARRIVARE A
ALCUNE TRA LE
CASSEFORTI PIÙ
"INTERESSANTI" DI
CLERVILLE. CONOSCO
I SISTEMI DI ALLAR-
ME, LE COMBINA-
ZIONI, I CODICI
DI ACCESSO.



ALLORA, PERCHÉ
CHIEDI IL MIO
AIUTO ?

PERCHÉ IO SONO
BRAVINA NEL PAR-
LARE, NELL'INTRI-
GARE... MA ASSO-
LUTAMENTE NEGATA
NELL'A TECNICA.
NON SO NEANCHE
DA CHE PARTE SI
COMINCI A DISINSE-
RIRE UN ALLARME,
A PREPARARE UN
CONGEGNO. IN SOM-
MA A FARE TUT-
TE QUELLE
COSE IN CUI
TU SEI
MAESTRO.





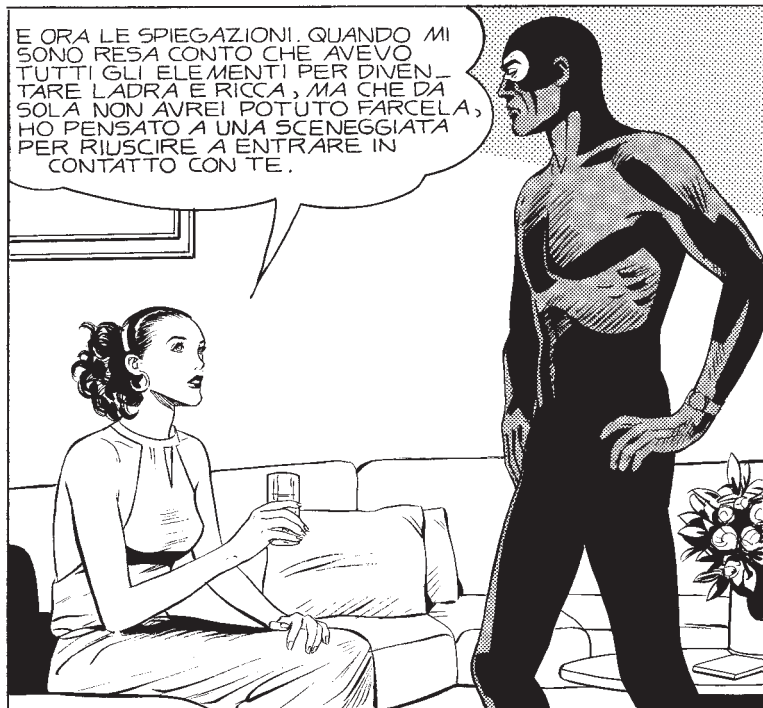

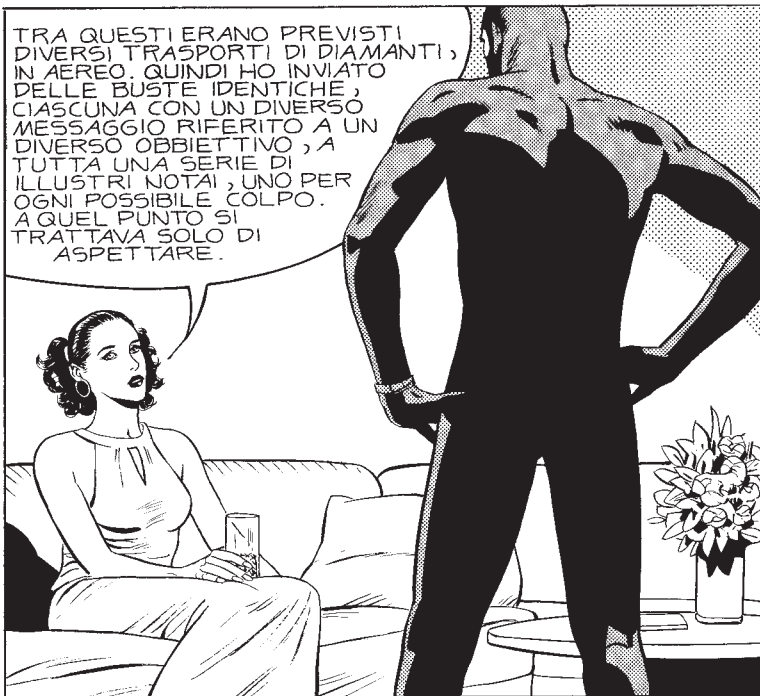

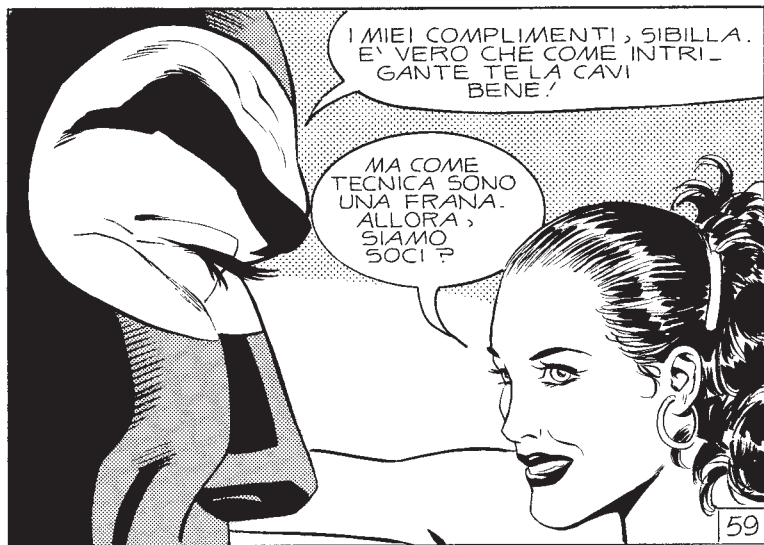

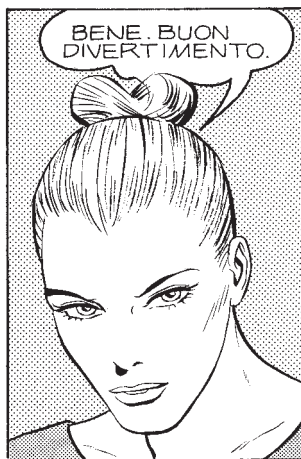





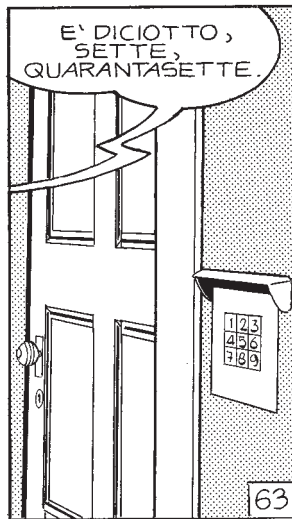

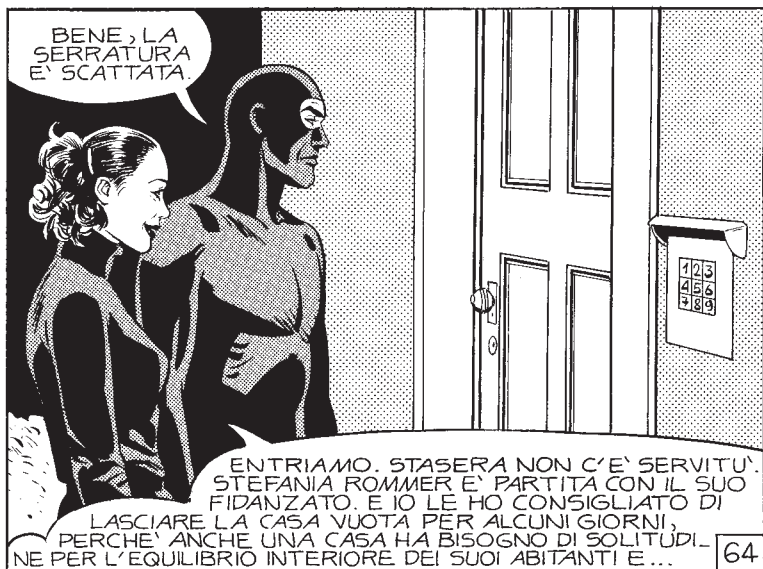



LO IMMAGINAVO. QUI C'È UN
RETICOLO AI RAGGI INFRAROSSI.

E...E ALLORA
COSA FACCIAMO?



PREVEDEVO
OSTACOLI SIMILI.
HO PORTATO GLI
OCCHIALI SPECIALI
ANCHE PER TE.
INDOSSALI.

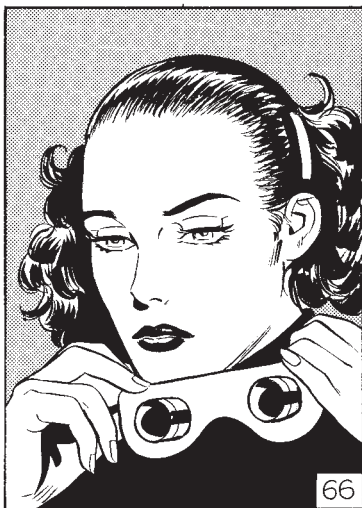

SANTO CIELO ! NON AVEVO
MAI VISTO NIENTE DI
SIMILE ...

DOBBIAMO PASSARE
SOTTO QUEL RETICOLO.
PENSI DI FARCELA ?

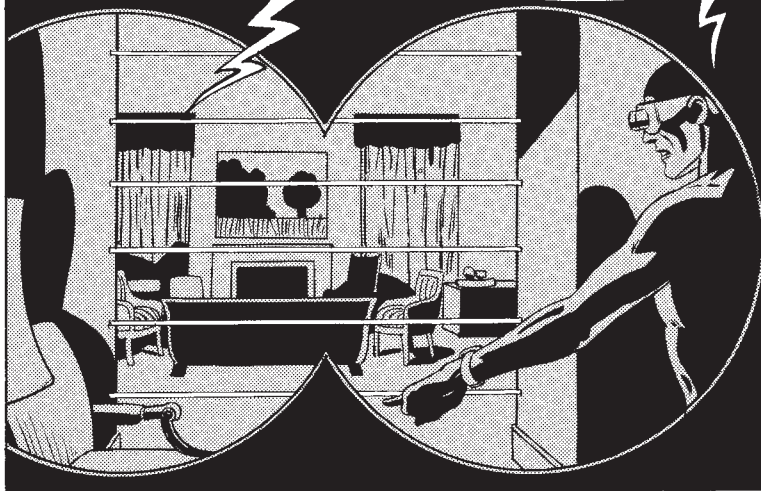

CERTO !
CIOE'... CI
PROVO.

POCO DOPO...

COME ME
LA STO
CAVANDO ?

BENE, SEI
FUORI !



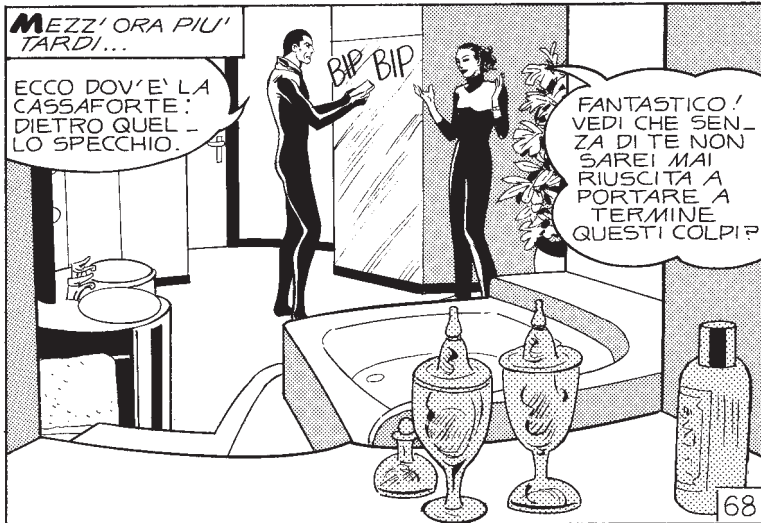

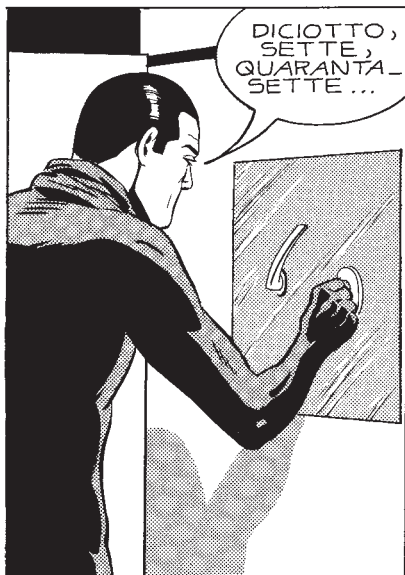

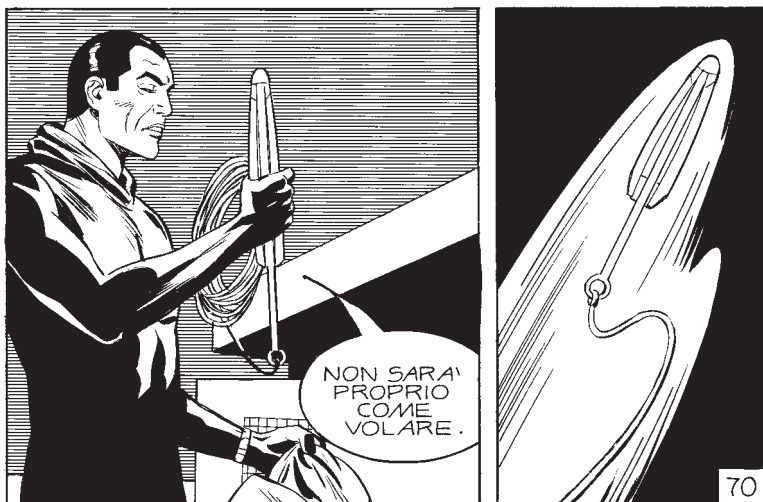
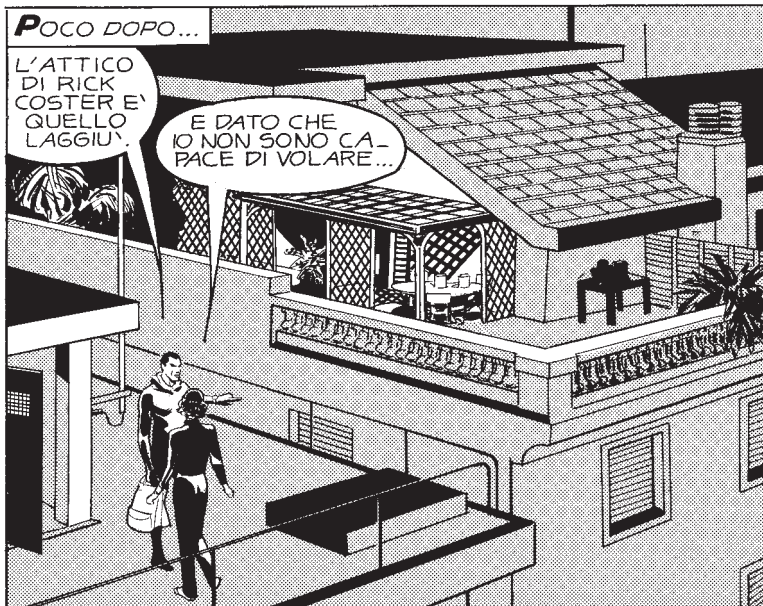

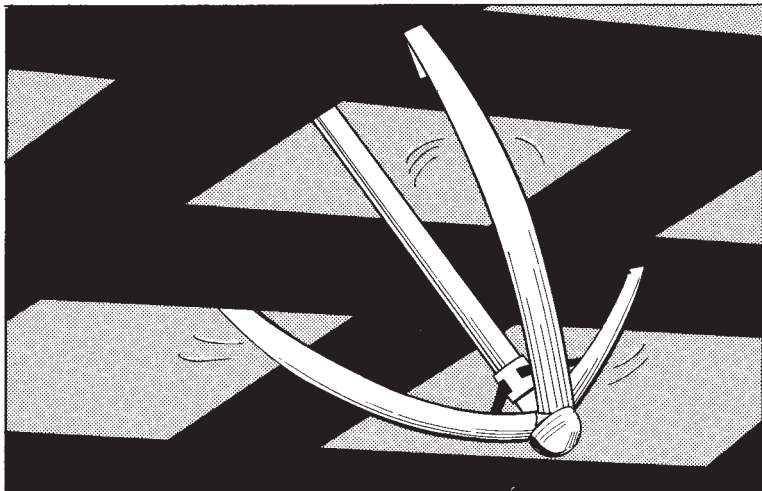

VADO PRIMA IO, COSI' TI
AIUTERO' QUANDO ARRI-
VERAI DALL'ALTRA PARTE.

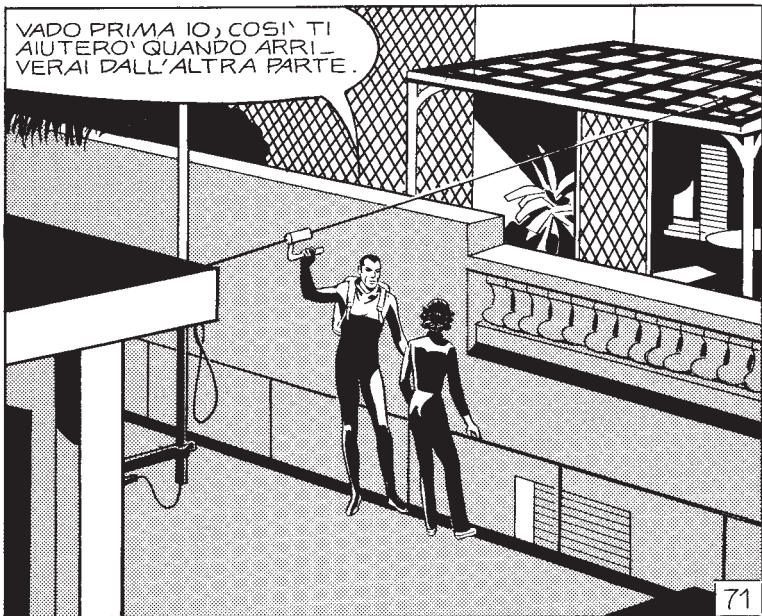

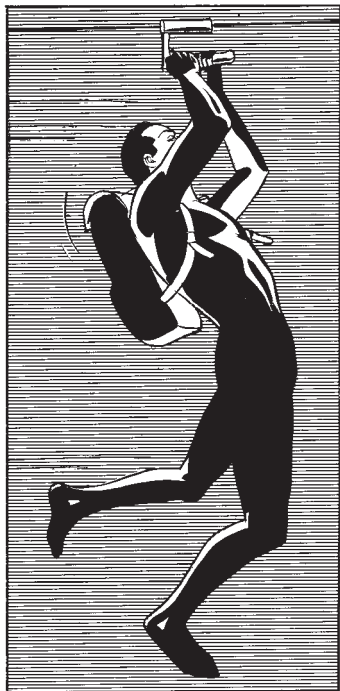



MA IO
SOFFRO DI
VERTIGINI!



E ALLORA COSA
CONTI DI FARE?
PREFERISCI
TORNARE INDIETRO?
VUOI
RINUNCIARE?

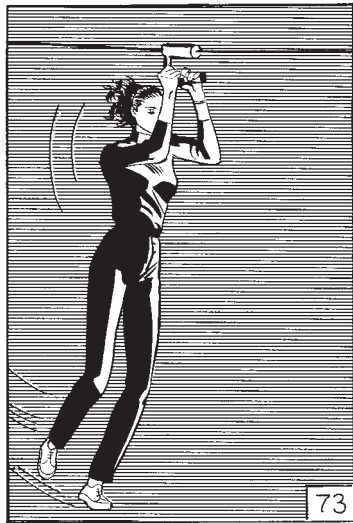



CE L'HAI
FATTA!

NON HO MAI AVUTO
NEANCHE IL CORAG-
GIO DI AFFACCIARMI
AL BALCONE
DEL PRIMO
PIANO.

SEI STATA
BRAVISSIMA,
SIBILLA...





POCO PIU' TARDI...

RICK COSTER HA IL TERRORE DI ESSERE DERUBATO. GLI HO SUGGERITO DI USARE COME COMBINAZIONE UNA PAROLA CHE GLI VENISSE DALL' ANIMA. SAI CHE PAROLA HA USATO?

NON PERDIAMO TEMPO CON GLI INDOVINELLI.

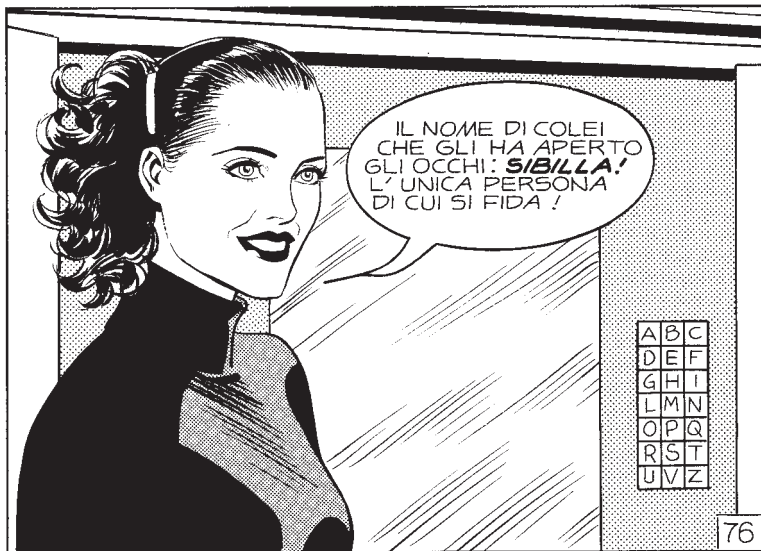

DOPO AVER APERTO LA CASSAFORTE...

NON RIESCO A CREDERCI. MA SONO
DAVVERO IO, SIBILLA
NAVČENKO, CHE
STA FACENDO
TUTTE QUESTE
COSE ?

SBRIGATI,
ALTRIMENTI...



...PERDI
IL TUO
AEREO.
E'
TRA
POCHE
ORE.

AH GIÀ'...
L'AEREO...



UN' ORA PIU' TARDI...

ORA ANDIAMO DA ROSA STEINER, L'ATTRICE. E' UN PO' MATTA. NON COMINCIA NEPPURE UN FILM, SE PRIMA NON HA CONSULTATO ME. L'HO MANOVRATA COME HO VOLUTO. HO FATTO PROPRIO UN CAPOLAVORO!



L'HO CONVINTA A ANDARE, ASSIEME A ANDREA WARD, IL PRODUTTORE DI CUI E' INNAMORATA COTTA, AL LAGO, FUORI CLERVILLE, SU UNA SPIAGGIA CHIAMATA "DELLE ROCCE BIANCHE". OGGI E' PLENILUNIO. LE HO CACCIATO IN TESTA CHE L'ESPOSIZIONE AI RAGGI DELLA LUNA SAREBBE EQUIVALSO A UN FILTRO D'AMORE. E ANCHE LUI SAREBBE USCITO PAZZO DI LEI.

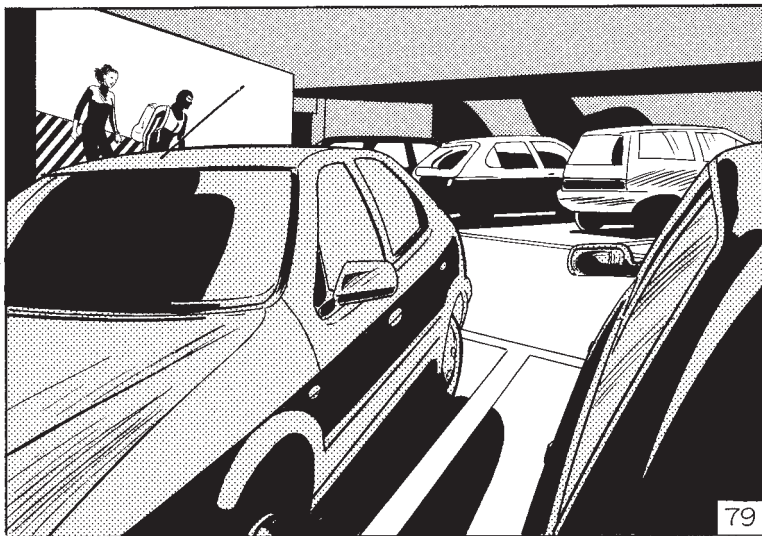
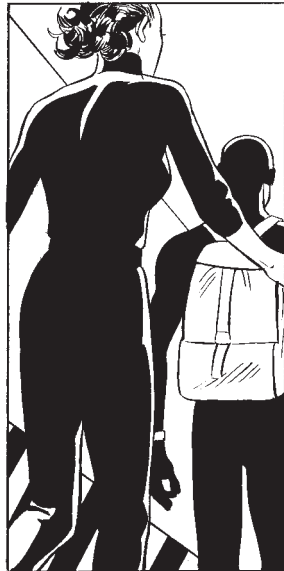

#IORESTOACASA - lettura gratuita

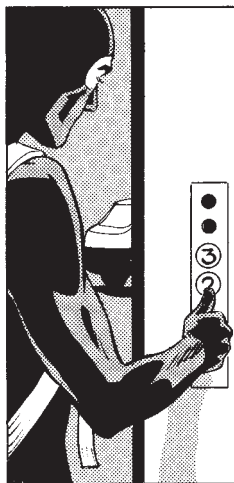
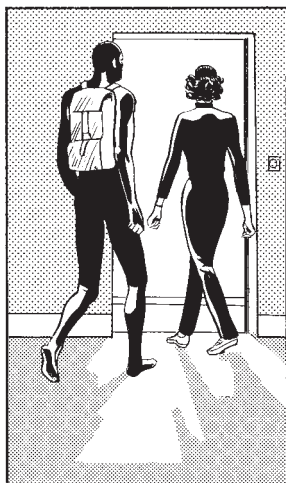







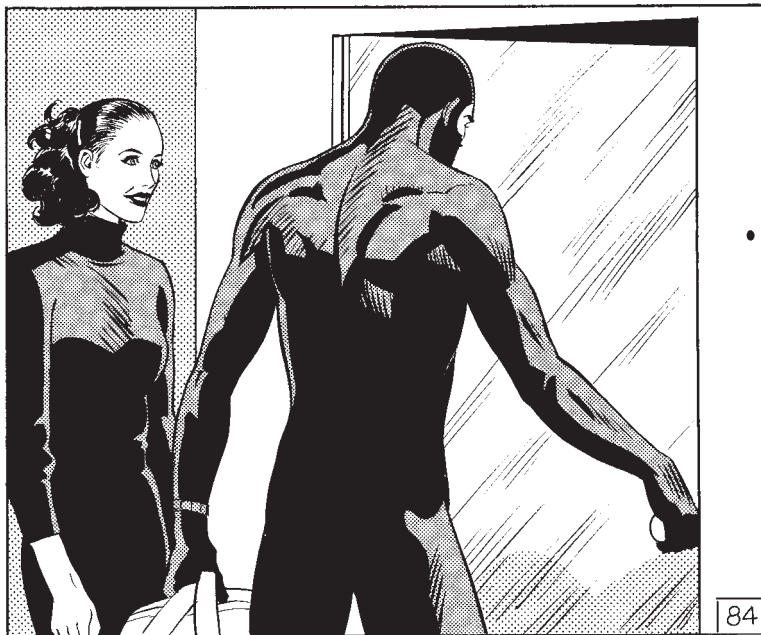
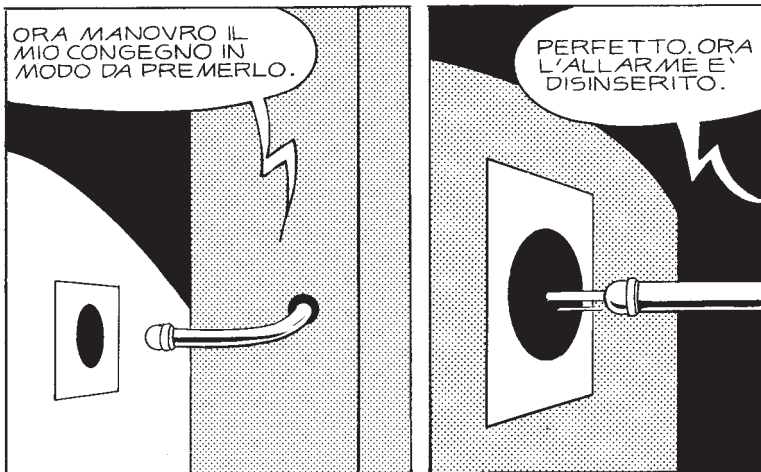











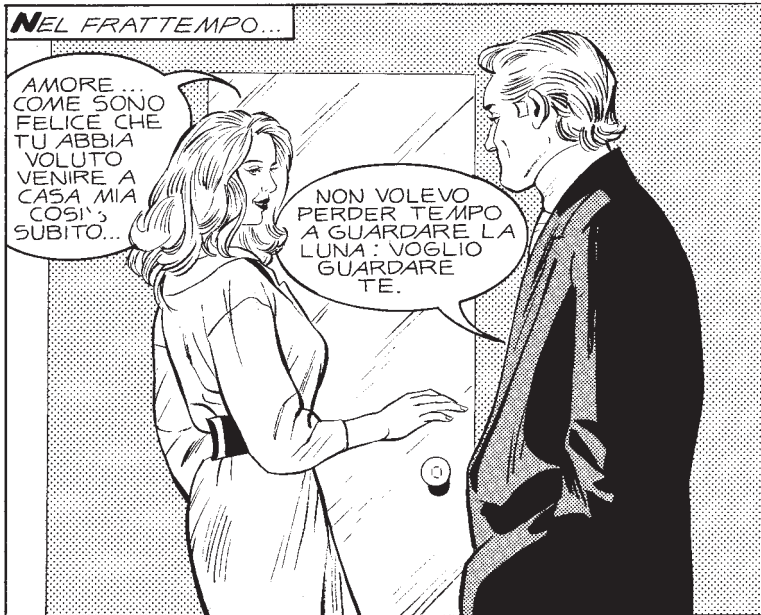

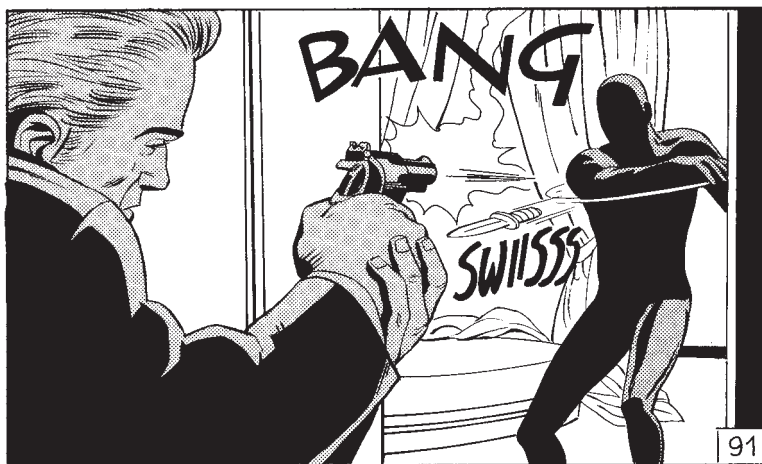

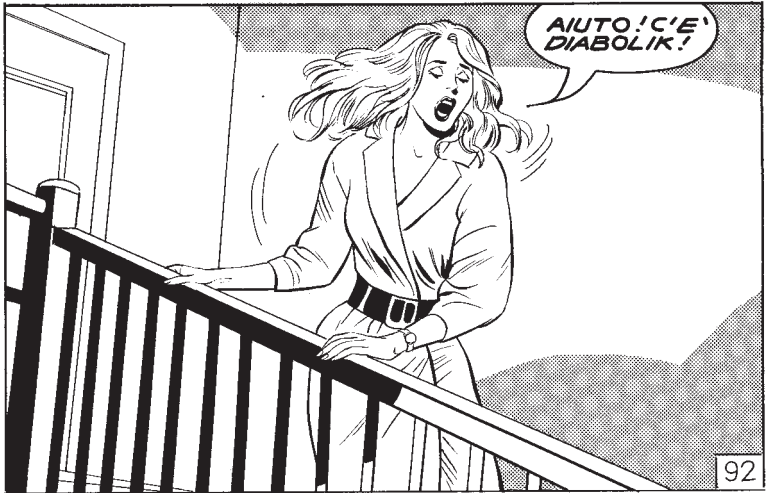

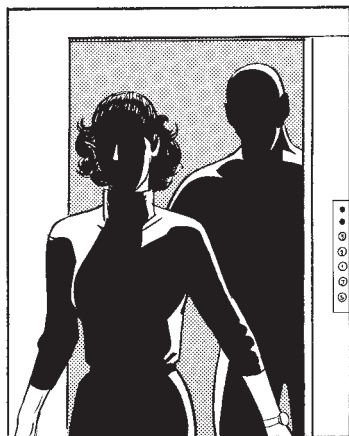
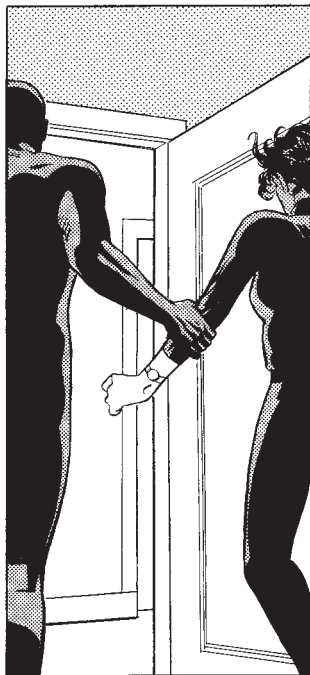



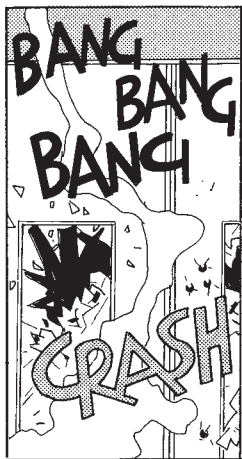

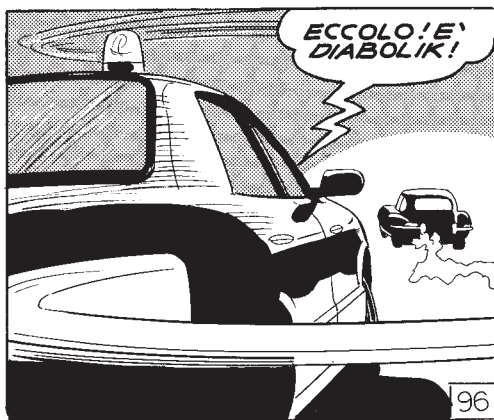
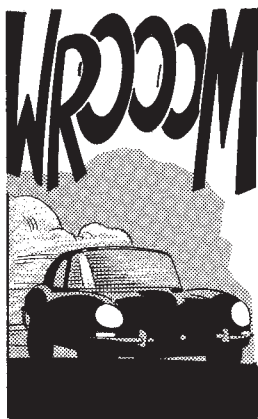



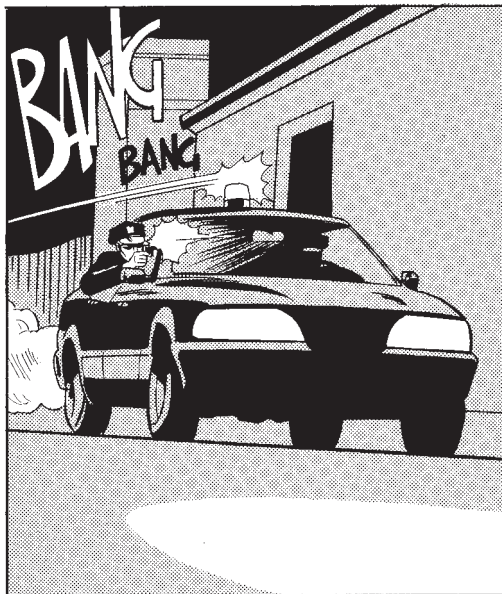



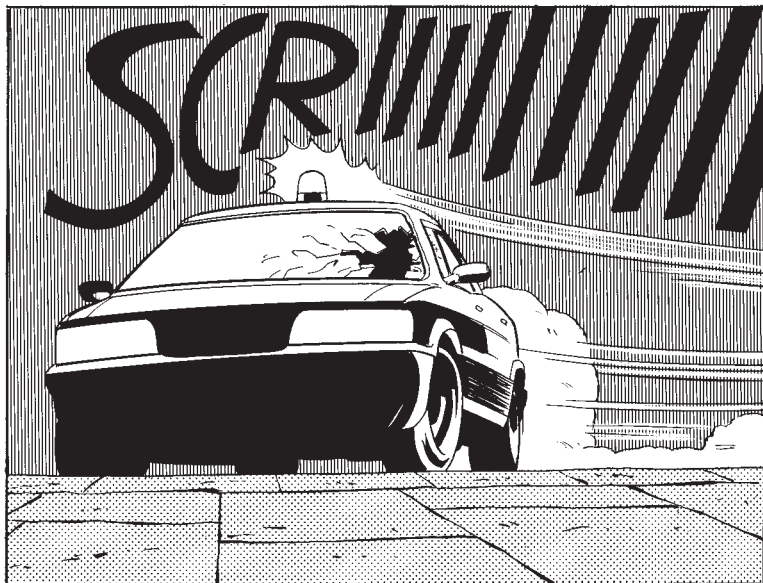

#IORESTOACASA - letture gratuite



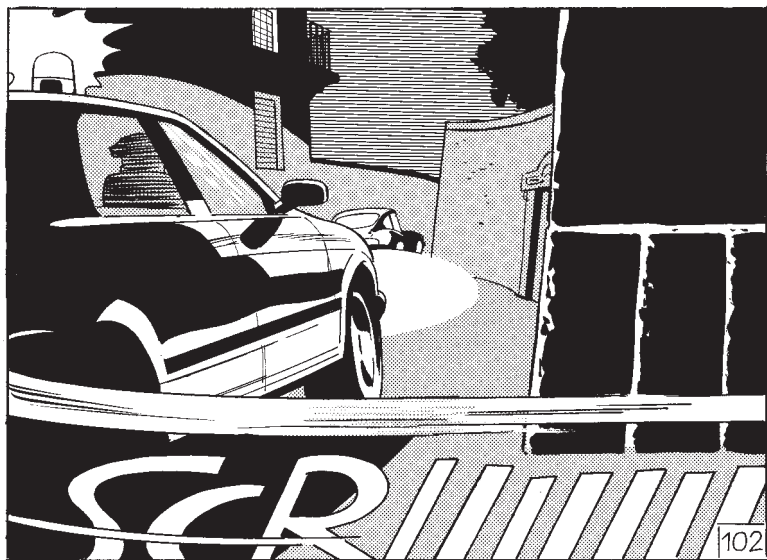
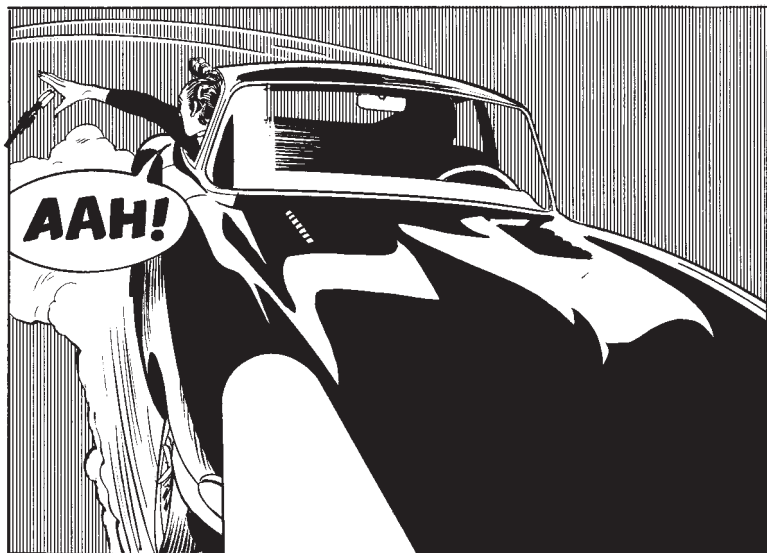

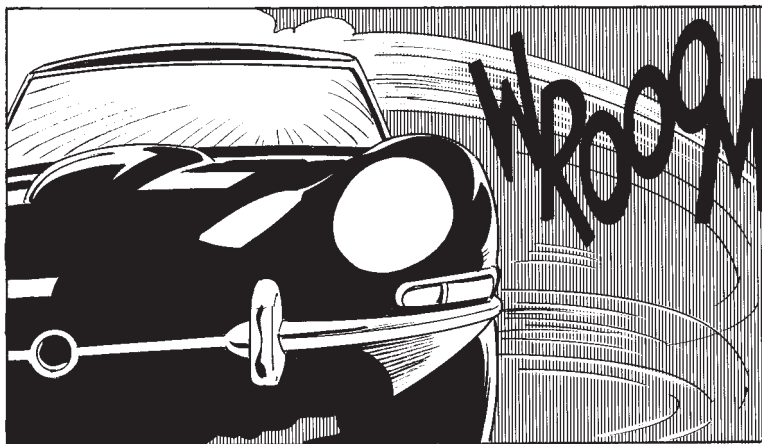
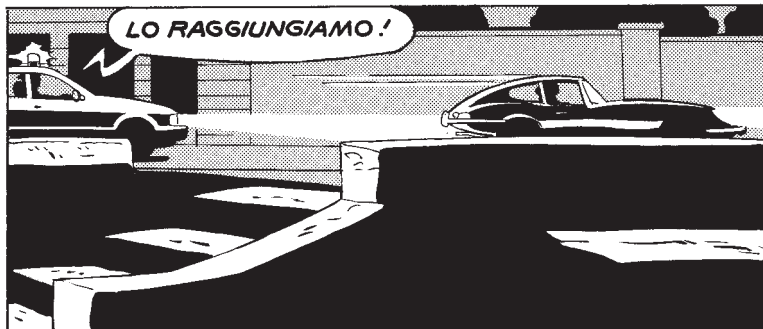

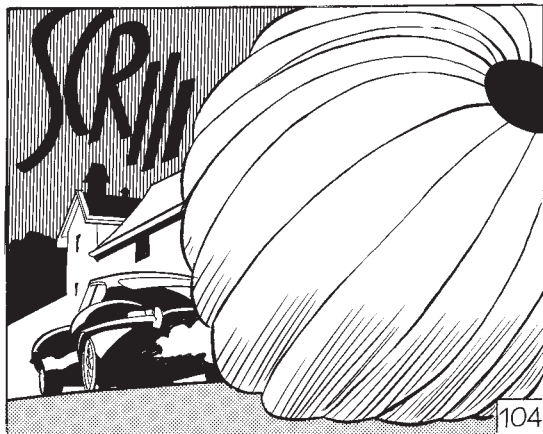
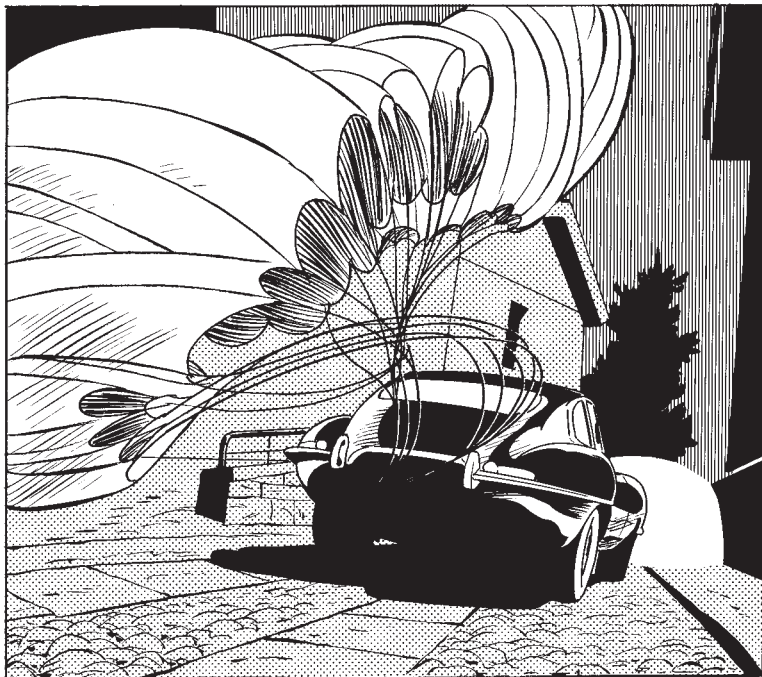

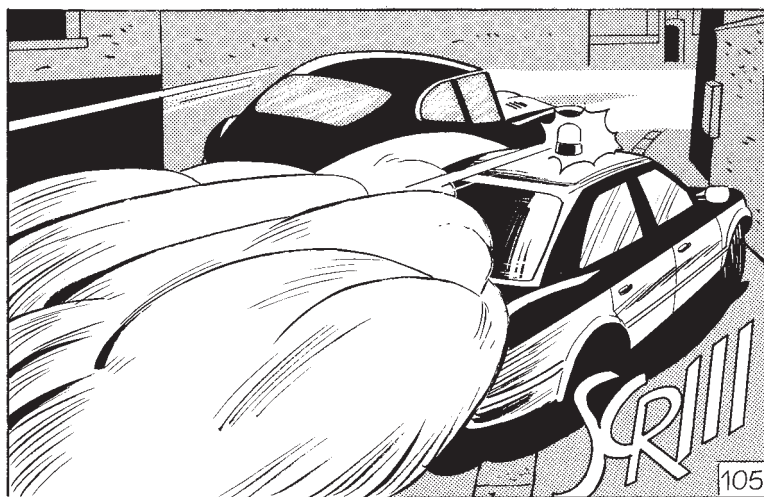
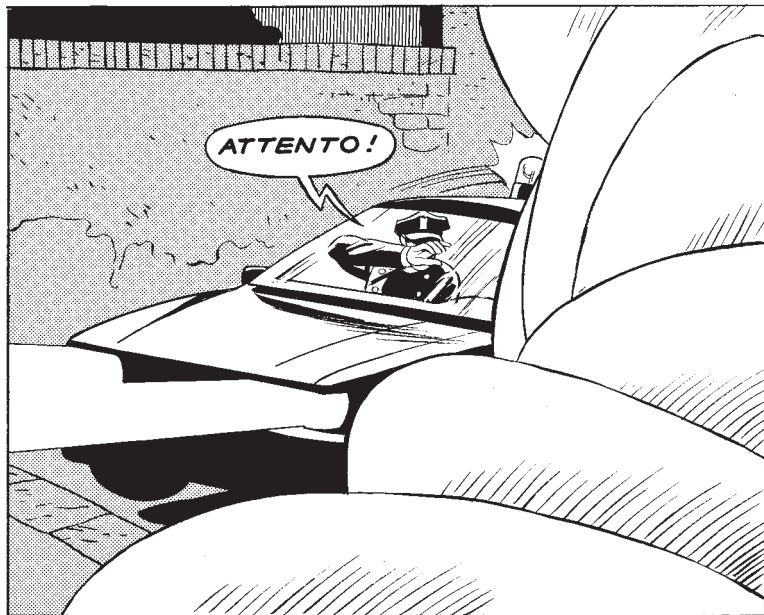



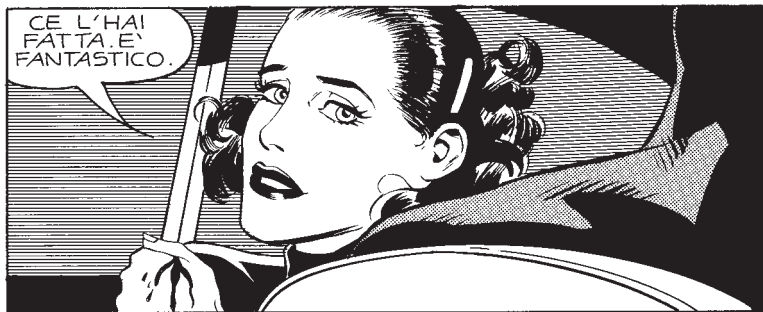



LA TUA EVA NON AVREBBE MAI
FATTO UN ERRORE COSI' CRETINO...
NO. APRIRE IL FINESTRINO...
ACCIDENTI... CON TUTTE LE ARIE
CHE MI DO, STO PER MORIRE...

SIBILLA, NON STAI PER
MORIRE. STAI UN PO'
ZITTA. L'INSEGUIMENTO
DELLA POLIZIA NON E'
ANCORA FINITO.



MI BUTTO
GIU'. TI
SONO
SOLO DI
OSTACO-
LO.

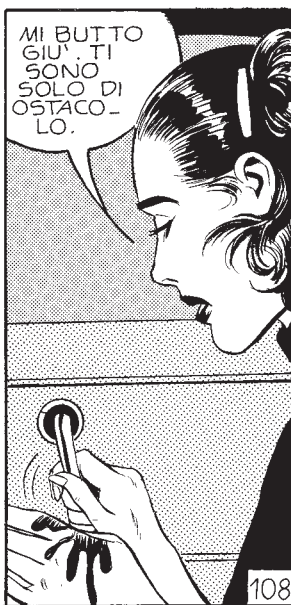

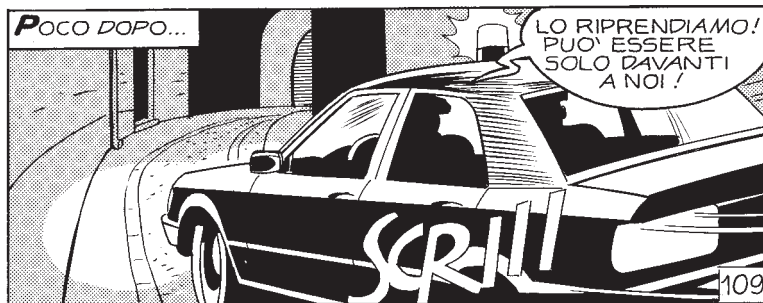
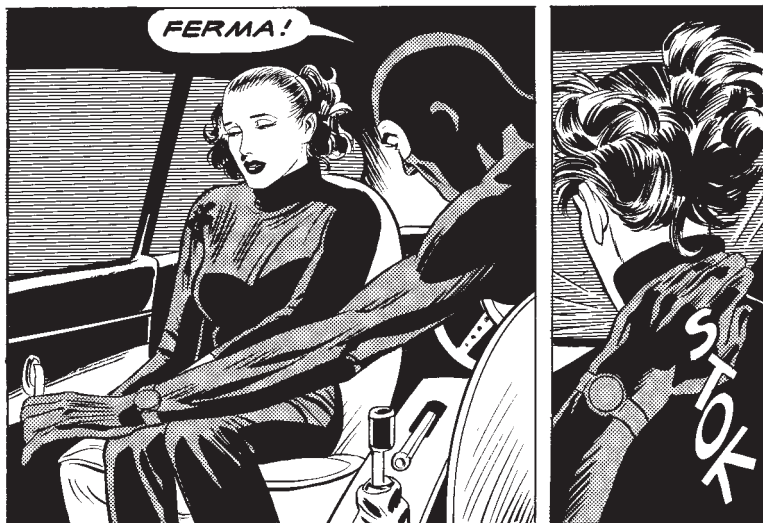

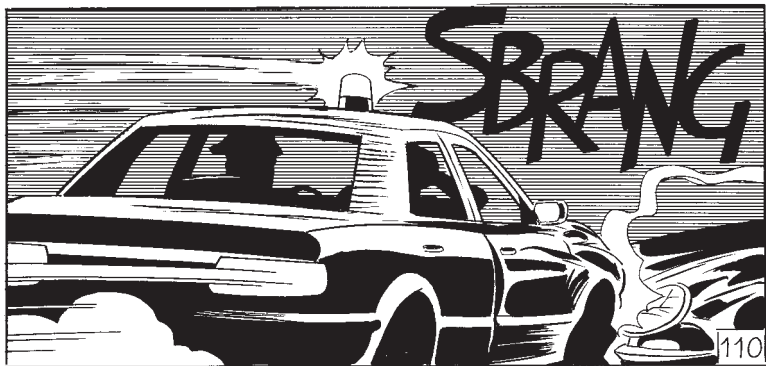
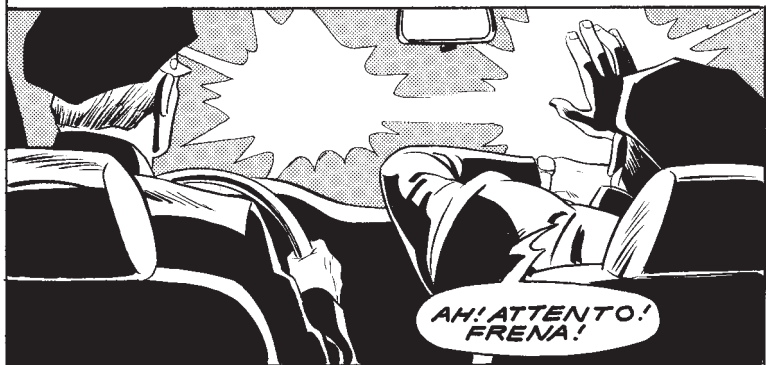
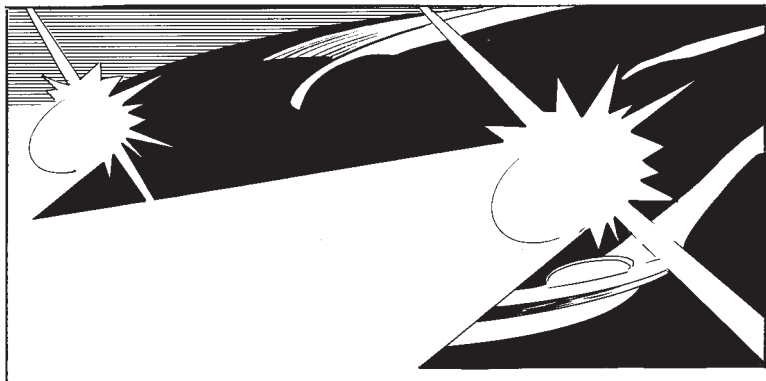

CHE BOTTA...NON CAPISCO PIU' NIENTE. PENSA CHE VEDO SOLO IL COFANO DI UNA MACCHINA...





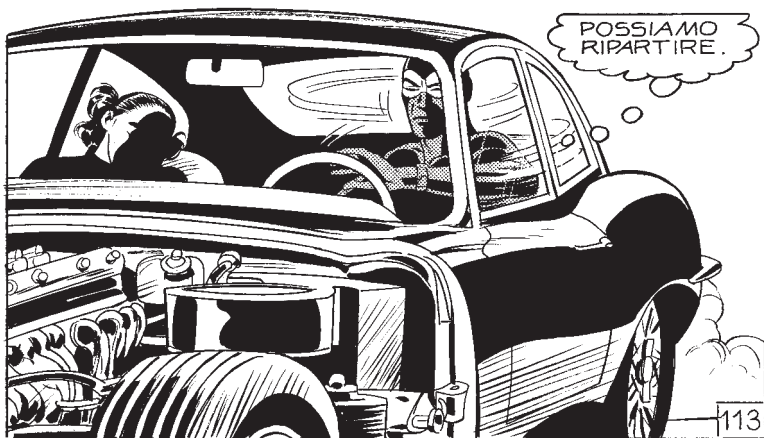
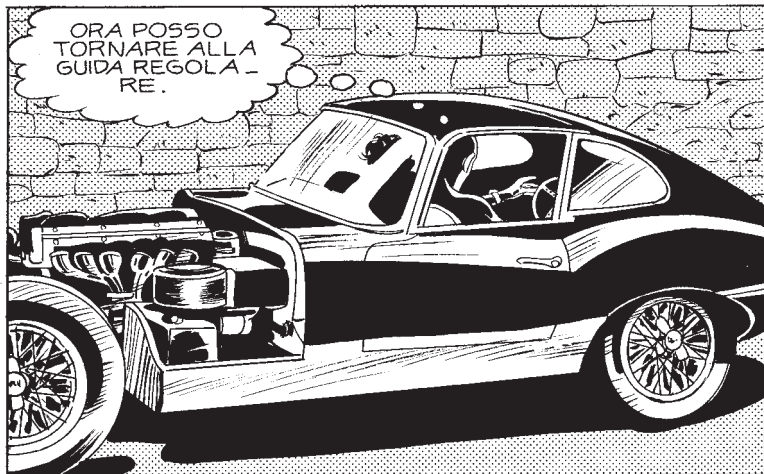

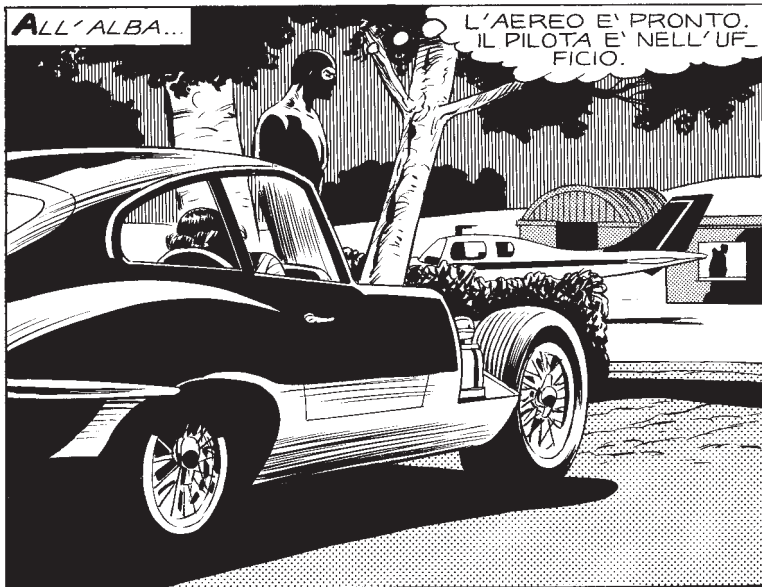

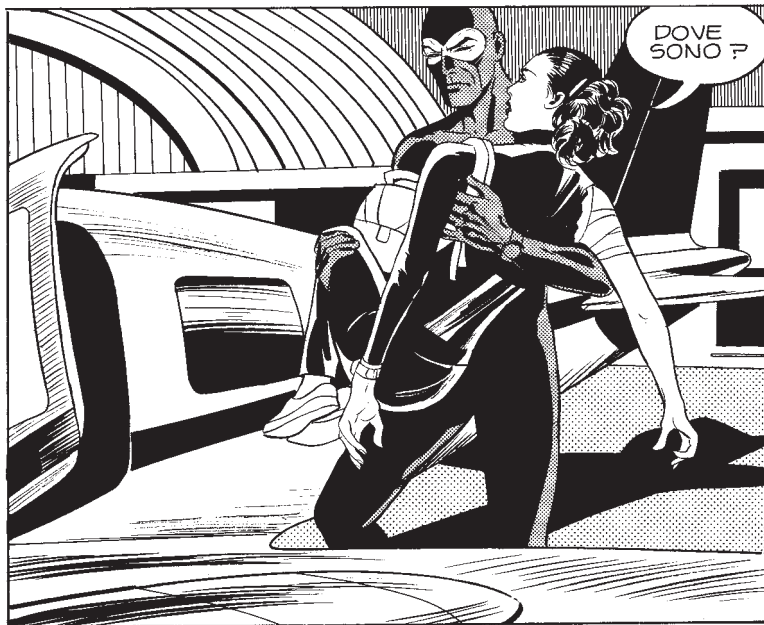

DOVE
SONO ?



MI HAI
PORTATO
SULL' AEREO!



LI' DENTRO C'E' LA
TUA PARTE DELLA
REFURATIVA. NON
SEI FERITA
GRAVEMENTE.
QUESTA SERA
STESSA SARAI
ALLE TUE ISOLE
DEI MARI
TROPICALI.

E' FORTUNATA,
EVA KANT. LA
INVIDIO...





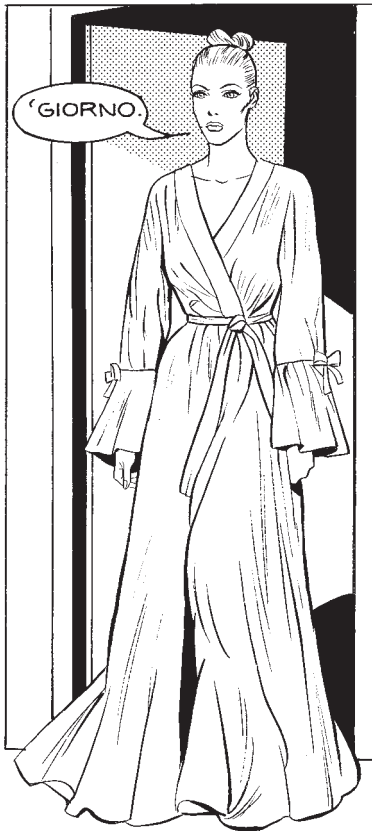
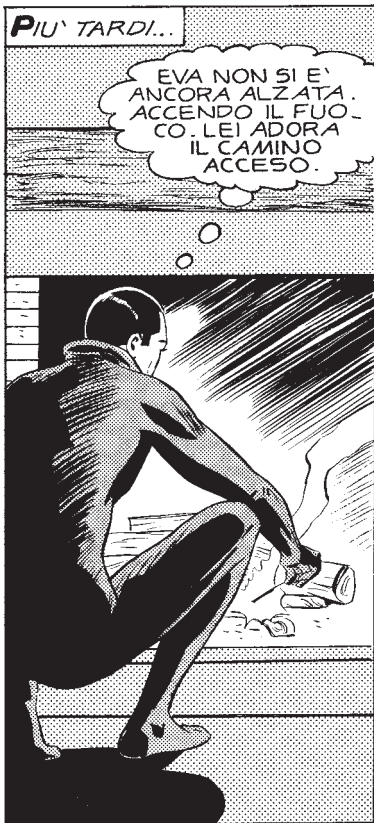





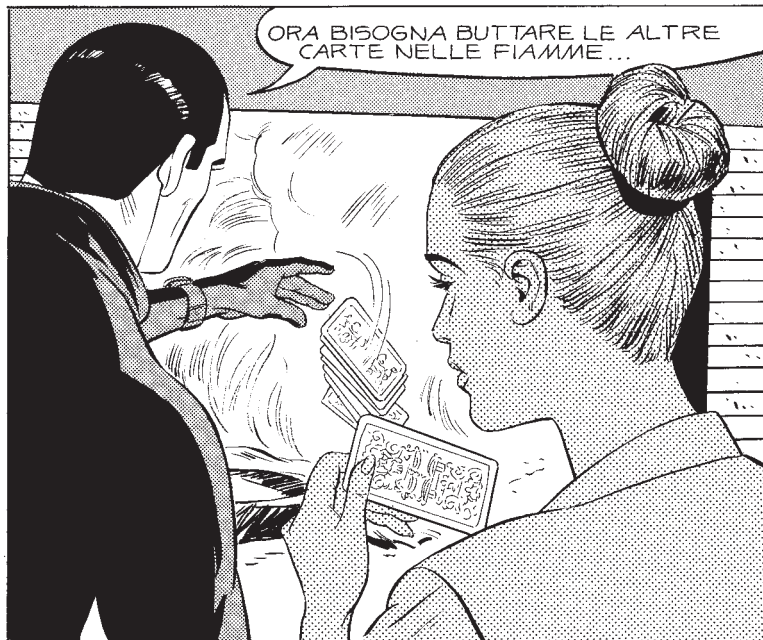

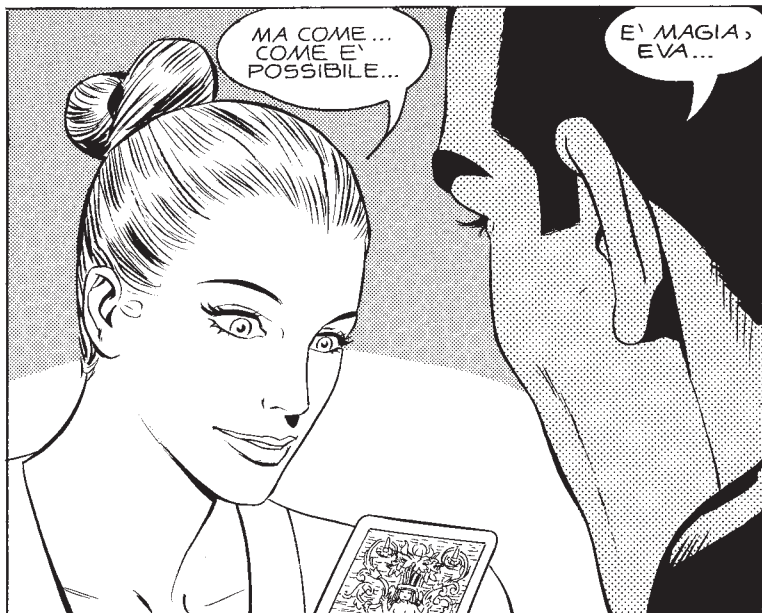



SIBILLA