

Nesso Bianco

Giancarlo Mattioli
Gruppo Architetti Urbanisti
Città Nuova

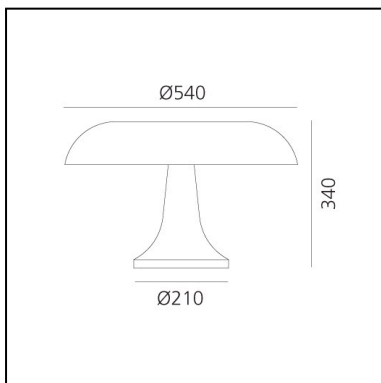

IP20   **EAC**  



LUMINAIRE *

– Watt : **4x5W**

– Tensione di alimentazione: **220V-240V**.
I rilievi fotometrici sono forniti in forma relativa e i calcoli illuminotecnici possono essere aggiornati in base alla sorgente effettiva impiegata.

DESCRIZIONE

Nesso è un'icona del design italiano degli anni 60, un decennio di conquista della modernità in cui il design ridisegna il paesaggio domestico attraverso le prime applicazioni delle materie plastiche. Innovativa e democratica, la sua forma espressiva ispirata alla natura interpreta e sfida la tecnologia produttiva industriale.

CARATTERISTICHE

- Codice Prodotto: **0056010A**
- Colore: **Bianco**
- Installazione: **Tavolo**
- Materiale: **Corpo e diffusore in tecnopolimero**
- Serie: **Design Collection, Modern Classic**
- Ambiente di utilizzo: **Interni**
- Emissione: **Diffusa E Diretta**
- design by: **Giancarlo Mattioli, Gruppo Architetti Urbanisti Città Nuova**

DIMENSIONI

- Altezza: **340 mm**
- Diametro: **540 mm**
- Diametro base: **210 mm**
- Resistenza all'impatto: **N/D**
- Prova del filo incandescente: **850°C**

SORGENTI NON FORNITE

- Categoria: **LED RETROFIT**
- Numero: **4**
- Watt: **MAX 6W**
- Attacco: **E14**

Dalù Arancio

Vico Magistretti



IP20   **EAC**  

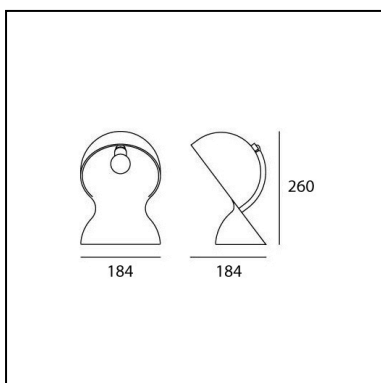

LUMINAIRE *

- Watt : **6W**
 - Tensione di alimentazione: **220V-240V**
 - Flusso luminoso emesso da sorgente installata: **345lm**
- * I rilievi fotometrici sono forniti in forma relativa e i calcoli illuminotecnici possono essere aggiornati in base alla sorgente effettiva impiegata.

DESCRIZIONE

Riedizione della lampada degli anni sessanta disegnata da Vico Magistretti, Dalù esprime lo spirito del nostro tempo. È proposta in diversi colori e finiture pur conservando l'inconfondibile design originario. La lampada è composta da una scocca in materiale termoplastico stampata.

CARATTERISTICHE

- Codice Prodotto: **1466070A**
- Colore: **Arancio**
- Installazione: **Tavolo**
- Materiale: **Policarbonato**
- Serie: **Design Collection**
- Ambiente di utilizzo: **Interni**
- Area di utilizzo: **Residential**
- Emissione: **Diretta, diffusa**
- design by: **Vico Magistretti**

DIMENSIONI

- Lunghezza: **184 mm**
- Larghezza: **184 mm**
- Altezza: **260 mm**
- Resistenza all'impatto: **N.D.**
- Prova del filo incandescente: **N.D.°**

SORGENTI NON FORNITE

- Categoria: **LED RETROFIT**
- Numero: **1**
- Watt: **MAX 6W**
- Attacco: **E14**

Amami

Naoto Fukasawa



IP20 

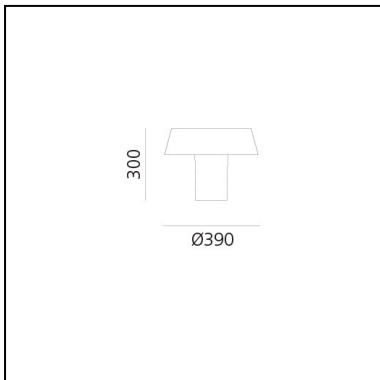

LUMINAIRE *

Watt: **12W**
* I Watt possono variare in base alla sorgente installata. I rilievi fotometrici sono forniti in forma relativa e i calcoli illuminotecnici possono essere aggiornati in base alla sorgente effettiva impiegata.

DESCRIZIONE

Amami è una lampada da tavolo con stelo e corpo diffusore in policarbonato opalino. Grazie alla sua assoluta semplicità formale, la lampada recupera l'effetto plastico e scultoreo della luce che filtra nei diversi strati e spessori del materiale creando a sua volta differenti densità.

CARATTERISTICHE

- Codice Prodotto: **DX0110A00**
- Colore: **Bianco**
- Installazione: **Tavolo**
- Materiale: **Policarbonato**
- Serie: **Design Collection, Danese**
- Ambiente di utilizzo: **Interni**
- design by: **Naoto Fukasawa**

DIMENSIONI

- Altezza: **300 mm**
- Diametro: **390 mm**

SORGENTI NON FORNITE

- Categoria: **LED RETROFIT**
- Numero: **1**
- Watt: **MAX 12W**
- Attacco: **E27**

Cri-Cri Outdoor Tavolo LED

DIMENSIONE

X X

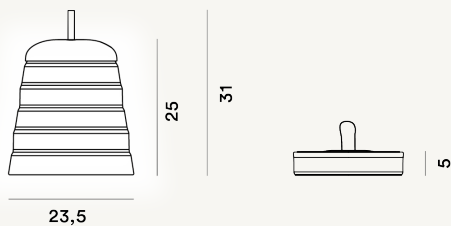

COLORE



Rosso, Verde

CERTIFICAZIONI



PESO

Net kg 1.00

MATERIALE

Silicone, ABS e PMMA.

CAVO

SORGENTE LUMINOSA

LED integrato 2,4W 2700 K 325lm CRI >80 Touch dimmer incluso

Binic Tavolo

DIMENSIONE

X X

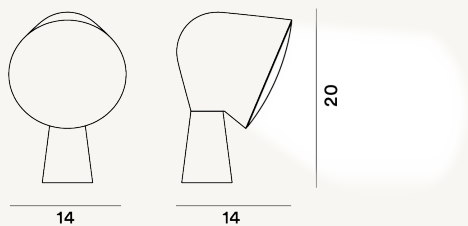

CAVO

Trasparente

COLORE



Antracite, Bianco, Blu, Giallo, Rosa, Verde
acqua

CERTIFICAZIONI
IP 20



PESO

Net kg 0.60

MATERIALE

ABS masterizzato e policarbonato.

SORGENTE LUMINOSA

Lampadina non inclusa E14 12W Max On-Off

TAKE 2003

Design Ferruccio Laviani

9050

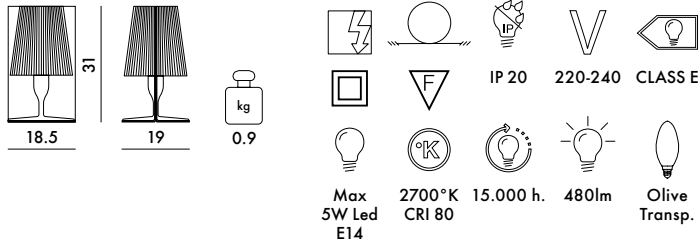

MATERIALE

Policarbonato 2.0 da materia prima rinnovabile trasparente o colorato in massa



Nuovo policarbonato 2.0, materiale che nella fase di sintesi, utilizza una materia prima rinnovabile derivante dall'industria della cellulosa e della carta. Il processo produttivo del materiale è Certificato ISCC* (International Sustainability and Carbon Certification)



JJ04

Pack da 1 lampadina E14 3.8W Led incluso
Non acquistabile separatamente

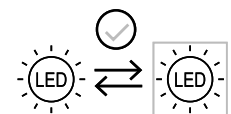

La sorgente luminosa può essere sostituita con sorgente analoga rispettando i dati indicati nell'etichetta dati targa. Si consiglia di utilizzare una sorgente luminosa con temperatura colore 2700 K.

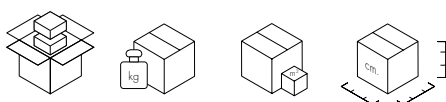

9050

1

1.1

0.011

19X19X32



209

Bouquet

Design BrogliatoTraverso, 2022

Rechargeable flower vase/ table lamp device.

In ABS injection moulded. LED technology, touch switch with dimmer function. Charging via USB-C cable, power supply not included. Power supply maximum 1,5W.

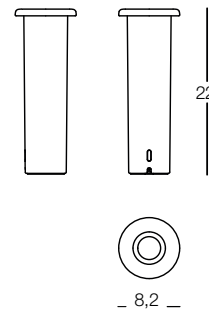

9405.29.90 | 0,005 m³ | 0,589 kg | 0,016 m³ | 0,79 kg

Art. nr	ABS injection		
LI100	colours	pack of 6	
LI101	colours	pack of 1	

Extra flower vase.

In ABS injection moulded.

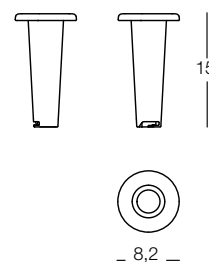

9405.29.90 | 0,016 m³ | 0,30 kg

Art. nr	ABS injection
LI102	colours

Colours

-  bordeaux 1796 C
-  black brown 1797 C
-  olive green 1798 C
-  caramel 1799 C
-  light blue 1800 C
-  beige 1801 C



To recharge the battery only use the battery cable supplied by Magis (USB 5V 1Amp).

Lost

Design Brogliato Traverso, 2021

Collection of lamps. Made up of table, floor, suspension, wall and ceiling lighting devices. Lamp body in painted ABS. Multi-led diffuser in PMMA (polymethylmethacrylate), especially designed to avoid Multi Shadow effect and dazzle.

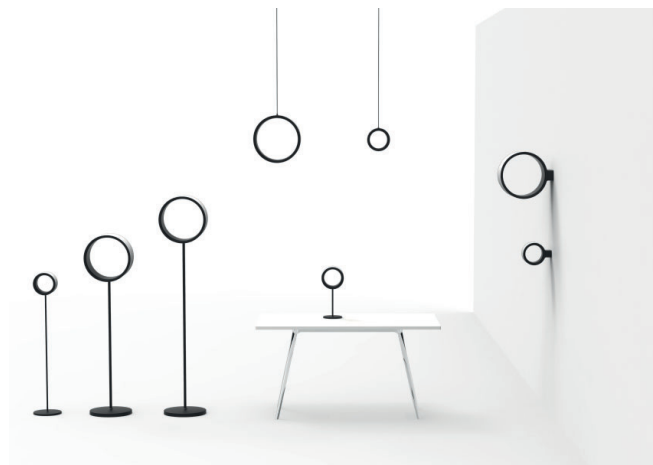
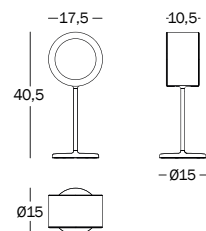

Table lamp.

Base in painted die-cast aluminium. Stemp in painted steel tube.
Light source included: 252 Mid Power Led 3000K
CRI90 1200 Lm power 9W.
Touch switch with dimmer function.
Power supply included.
Cable length: 2m.



9405.20.99 | 0,028 m³ | 0,80 kg

Art. nr

LI20

Floor lamp S, (H. 111cm).

Base in painted die-cast aluminium. Stemp in painted steel tube.
Light source included: 252 Mid Power Led 3000K
CRI90 1200 Lm power 9W.
Touch switch with dimmer function.
Power supply included.
Cable length: 2m.

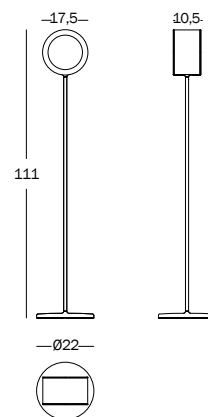

9405.20.99 | 0,079 m³ | 2,58 kg

Art. nr

LI25

Lamp

 black 5140

MINI KABUKI 2018

Design Ferruccio Laviani



9200 dimmerabile

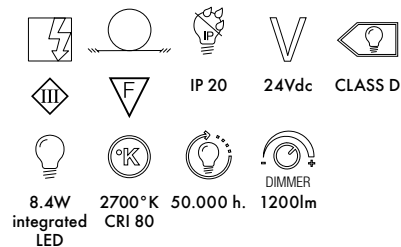

MATERIALE

Policarbonato 2.0 da materia prima rinnovabile trasparente, colorato in massa o effetto soft touch



TRASPARENTI



B4
Cristallo

MAT



ZA
Azzurro



BE
Beige



BO
Bordeaux

COPRENTI



O3
Bianco



O9
Nero



Nuovo policarbonato 2.0, materiale che nella fase di sintesi, utilizza una materia prima rinnovabile derivante dall'industria della cellulosa e della carta. Il processo produttivo del materiale è Certificato ISCC* (International Sustainability and Carbon Certification)



Alimentatore incluso 100V-240V



RICAMBI

9202000
Dimmer, Modulo LED

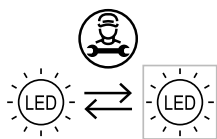

La sorgente luminosa contenuta in questo apparecchio deve essere sostituita solamente da personale qualificato utilizzando ricambi originali.



1



2.83



0.11

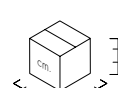

38X37X84

9060

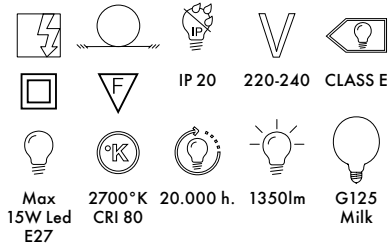
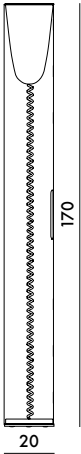

9065

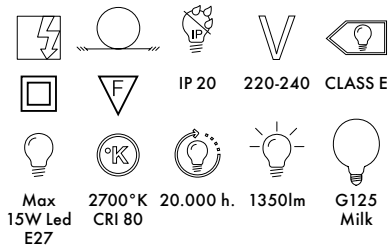
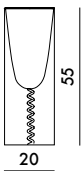

STRUTTURA

PMMA trasparente

DIFFUSORE

Policarbonato

TRASPARENTI



B4
Cristallo

JJ06

Pack da 1 lampadina E27 12W Led inclusa
Non acquistabile separatamente

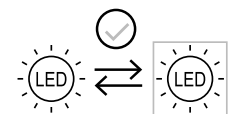

La sorgente luminosa può essere sostituita con sorgente analoga rispettando i dati indicati nell'etichetta dati targa. Si consiglia di utilizzare una sorgente luminosa con temperatura colore 2700 K.

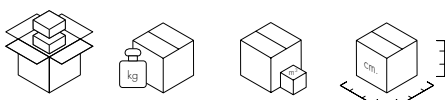

9060	1	10.7	0.142	28X181X28
9065	1	3.05	0.049	27X67X27



FLOS

 F3780002 Orange

Mayday

Designed by Konstantin Grcic, 2000



Halogen - 60W

Multipurpose lighting appliance. Hook/handle, which also works as a cable winder, and an injection-moulded opaline conical diffuser made from sustainable polypropylene produced from industrial process waste. Button switch located on the handle. As no glue is used in the assembly process, Mayday is easy to dismantle so that every part can be properly recycled.

Are you a professional and your project needs consulting and support?

[BOOK AN APPOINTMENT](#)

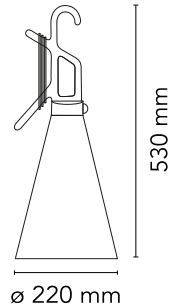

Main specifications

EAN	8059607019887
Mounting	Suspension
Environments	Indoor dry location
Light source type	Bulb
Light sources included	No
Lamp category	Halogen
Lamp holders	E27
Icos	HSGSA
Number of lamps	1
Power (W)	60

Physical

Colour	Orange
Length (mm)	220
Cord colour	Black
Cord length (mm)	4850
Net weight (kg)	0.75
Package height (mm)	550
Package width (mm)	225
Package length (mm)	225
Package volume (m3)	0.03
IP internal	20

Download

Mounting instructions [↓ PDF](#)

Photometric Files

LDT / IES [↓ LDT](#)

Technical Drawings

2D [↓ ZIP](#)

3D [↓ ZIP](#)



IK
00

NEW!

TERESA 2024

Design Ferruccio Laviani



9105

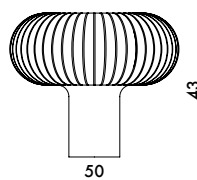

		IP 20	220-240	CLASS C
Max 11W Led E27	2700°K CRI 80	20.000 h.	DIMMER 270lm 1800lm	G125 Milk

MATERIALE

PMMA riciclato colorato in massa

AM Arancio	AZ Azzurro	PE Petrolio	MV Malva



Prodotto in materiale riciclato



JJ20

Pack da 1 lampadina E27 11W G125 MILK Led incluso
Non acquistabile separatamente

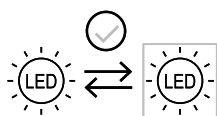

La sorgente luminosa può essere sostituita con sorgente analoga rispettando i dati indicati nell'etichetta dati targa. Si consiglia di utilizzare una sorgente luminosa con temperatura colore 2700 K.

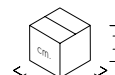

9105

1

5.6

0.129

53X53X46



LIGHT-AIR 2013

Design Eugeni Quitllet



9131 Sospensione

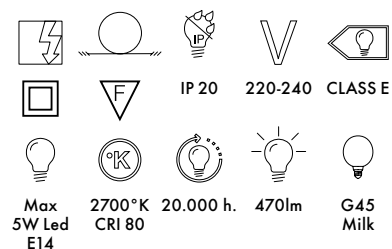
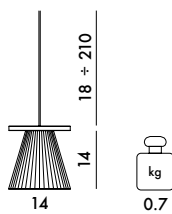

9125 Applique

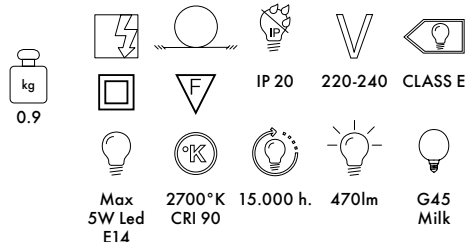
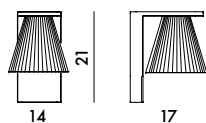

9110 Lampada da tavolo

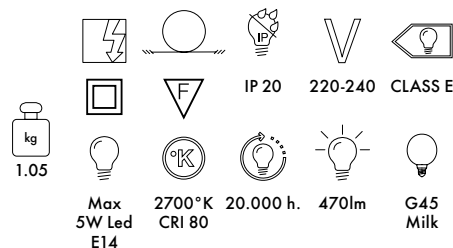
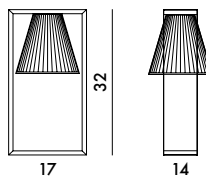

STRUTTURA

Tecnopolimero termoplastico trasparente

DIFFUSORE

Tecnopolimero termoplastico trasparente rivestito in tessuto

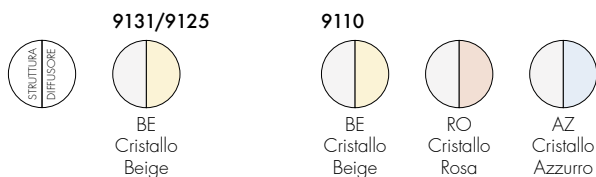

JJ02

Pack da 1 lampadina E14 4W Led incluso
Non acquistabile separatamente

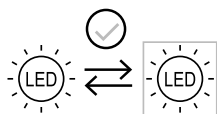

La sorgente luminosa può essere sostituita con sorgente analoga rispettando i dati indicati nell'etichetta dati targa. Si consiglia di utilizzare una sorgente luminosa con temperatura colore 2700 K.

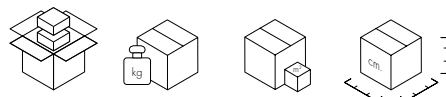

9110	1	1.5	0.015	23X41X16
9125	1	1.345	0.013	23X29X19
9131	1	1.09	0.013	23X29X19

9130

Sospensione versione sculturata

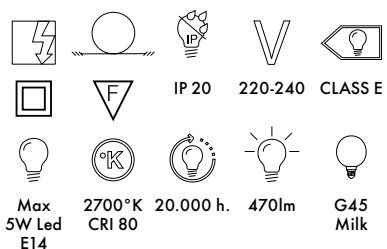
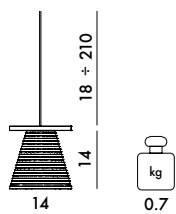

9120

Applique versione sculturata

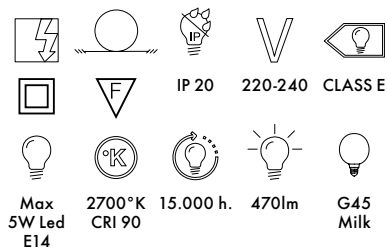
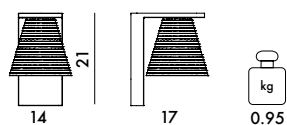

9135

Lampada da tavolo sculturata

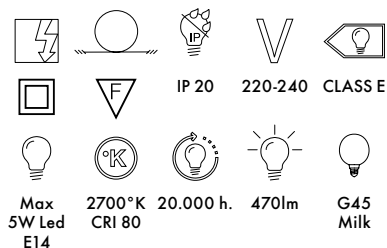
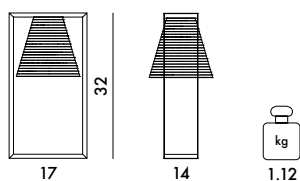

MATERIALE

Tecnopolimero termoplastico trasparente o colorato in massa

9120/9130/9135

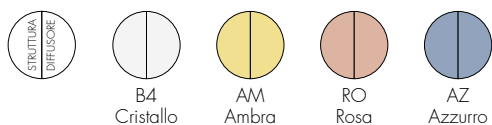

9135



JJ03

Pack da 1 lampadina E14 4W Led incluso
Non acquistabile separatamente

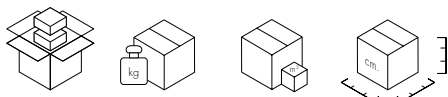

9120	1	1.3	0.013	23X29X19
9130	1	1.05	0.013	23X29X19
9135	1	1.47	0.015	23X41X16

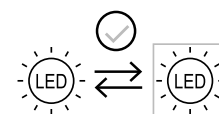

La sorgente luminosa può essere sostituita con sorgente analoga rispettando i dati indicati nell'etichetta dati targa. Si consiglia di utilizzare una sorgente luminosa con temperatura colore 2700 K.



FLOS

F7761048 Ochre-Grey

Tatou Table

Designed by Patricia Urquiola, 2012



Halogen - 70W

Diffused light table lamp. Exterior diffuser in Polycarbonate. Internal diffuser in injection printed opal polycarbonate. Support and base in painted steel.

Are you a professional and your project needs consulting and support?

[BOOK AN APPOINTMENT](#)

Main specifications

Mounting	Table
Environments	Indoor dry location
Light source type	Bulb
Light sources included	No
Lamp category	Halogen
Lamp holders	E27
Icos	HSGS / FBT
Number of lamps	1
Power (W)	70

Physical

Colour	Ochre-Grey
Length (mm)	280
Cord colour	Clear
Cord length (mm)	1500
Net weight (kg)	2.7
Package volume (m3)	0.07
IP internal	20

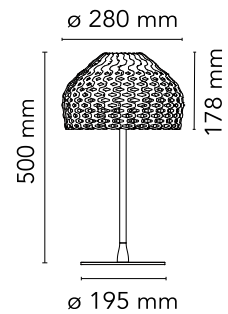

Download

Mounting instructions [↓ PDF](#)

Photometric Files

LDT / IES [↓ LDT](#)

Technical Drawings

2D [↓ ZIP](#)

3D [↓ ZIP](#)



■ F1060031 Matte Black

Bellhop Table

Designed by Edward Barber and Jay Osgerby, 2018



3W - 151lm - 2700K

Rechargeable direct light table lighting device. Base and dome in coloured PC. Diffuser in Opaline injection moulded photo-engraved PC. 24-hours' autonomy, charging via Micro-USB-C. Push-button switch positioned on the base provides the 4-step dimmer function. Battery status indicator positioned under the base. USB-C charging cable included, useful length 120cm.

Are you a professional and your project needs consulting and support?

[BOOK AN APPOINTMENT](#)

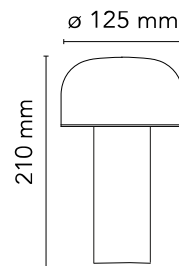

Main specifications

EAN	8059607047033
Mounting	Table
Environments	Indoor dry location
Light source type	LED
Light sources included	Yes
LED type	LED Module
Power (W)	3
System flux (lm)	151

Physical

Colour	Matte Black
Length (mm)	125
Net weight (kg)	1.3
Package height (mm)	200
Package width (mm)	200
Package length (mm)	330
Package volume (m3)	0.01
IP internal	20

Download

Mounting instructions



Ecodesign and Energy Labelling

This product contains a light source of energy efficiency class C

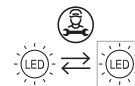

Replaceable (LED only) light source by a professional

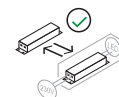

Replaceable control gear by an end-user



FLOS

F1040039 Fresh Mint

Bon Jour Unplugged NEW

Designed by Philippe Starck, 2015



3W - 150lm - 2200-2700-3000K - CRI> 90

Cordless table lamp providing direct light. Injection moulded body and PMMA clear transparent diffuser. Edge Lighting technology light source. 6/24 hours battery life, rechargeable with USB C and Qi. Optical switch sensor on the base that provide 4-step dimming function and Color temperature control on 3-steps (2200K, 2700K and 3000K). USB-C charger cable included in the package useful length 120 cm

Are you a professional and your project needs consulting and support?

[BOOK AN APPOINTMENT](#)

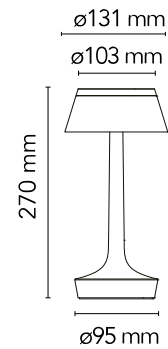

Main specifications

EAN	8059607070949
Mounting	Table
Light source type	LED
Light sources included	Yes
LED type	LED Module
Power (W)	3
System flux (lm)	150

Physical

Colour	Fresh Mint
Length (mm)	110
Net weight (kg)	0.45
Package height (mm)	200
Package width (mm)	160
Package length (mm)	365
Package volume (m3)	0.01
IP internal	20

Download

[Mounting instructions](#)



Ecodesign and Energy Labelling

This product contains a light source of energy efficiency class G

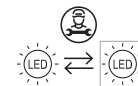

Replaceable (LED only) light source by a professional



WELCOME

Fabio Novembre,



Welcome è un oggetto di design che si adatta all'ambiente e allo stile di vita di chi lo abita, pensato per destinazioni d'uso diverse: lampada portatile e ricaricabile con emissione di luce diretta, è alzatina su un tavolo imbandito, è portaoggetti e svuota-tasche. Proposto nei colori bianco, nero e rosso, per essere perfettamente integrato in qualsiasi contesto domestico e di ristorazione, indoor e outdoor. "La tecnologia che usiamo nel quotidiano ha portato ad una ibridazione delle funzioni che ormai fa parte della nostra vita. Non sono più sicuro che una lampada debba soltanto portare luce. Forse questi piccoli strumenti che ci affiancano in ambienti e atmosfere diverse, su un tavolo da pranzo o su un comodino accanto al nostro letto, potrebbero aiutarci anche ad accogliere altri oggetti, a metterli in risalto o semplicemente a tenerli a portata di mano. Welcome nasce da un gesto di inclusione, una felice convivenza di funzioni per accostamenti inaspettati." Fabio Novembre

Lampada portatile con luce diretta a LED, utilizzabile anche come centrotavola. Realizzata in materiale plastico ABS colorato in massa, il diffusore è in PMMA trasparente opalino di colore nero. Un pulsante touch trasparente permette l'accensione, lo spegnimento e la regolazione dell'intensità della luce oltre ad indicare il livello di carica. La lampada è alimentata da una batteria della durata di 8 ore e ricaricabile mediante cavo con presa USB. Uso interno/esterno. Made in Italy.

SKU

D91114L648091

MATERIALE

abs

COLORE

nero

FLOS

F6607004 Silver

Taccia (PMMA)

Designed by Achille and Pier Giacomo Castiglioni, 1962



28W - 2700K

Table lamp providing indirect and reflected light. Reflector in painted aluminium, gloss white on the outside and matt white on the inside. Directionable diffuser in transparent PMMA. Body in matt black or naturally anodized extruded aluminium. Base in nickel-plated metal. Electric cable of useful length 220 cm, with dimmer switch for ON/OFF and adjustment of the light flow between 10-100%. Plug-in power supply with interchangeable plugs.

Are you a professional and your project needs consulting and support?

[BOOK AN APPOINTMENT](#)

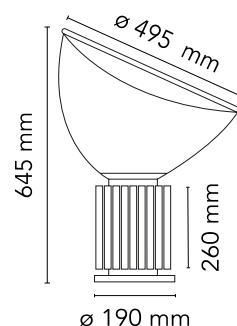



Main specifications

Mounting	Table
Environments	Indoor dry location
Light source type	LED
Light sources included	Yes
LED type	LED array
Power (W)	28

Physical

Colour	Silver
Length (mm)	190
Cord colour	Black
Cord length (mm)	2200
Net weight (kg)	7.6
Package volume (m3)	0.18
IP internal	20

Download

[Mounting instructions](#)  PDF
[Mounting instructions](#)  PDF

Ecodesign and Energy Labelling

This product contains a light source of energy efficiency class D



Replaceable (LED only) light source by a professional

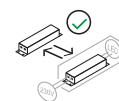

Replaceable control gear by an end-user

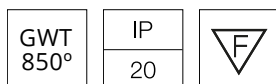



In 1961 this lamp was part of Miguel Milá's first collection for TRAMO, the company he founded to produce his own work in post-war Spain. He dabbled in a profession that he would later go on to master, that of a pre-industrial designer, as he likes to introduce himself.

Asa is built of a single, continuous tube. Lightweight, yet robust, the handle-shaped structure makes it easy to carry everywhere. Three visible elements that make up a whole.

General description:

White or black metal structure with matte finish.
White translucent methacrylate lampshade.
Switch incorporated into the luminaire.
Electric cable length: 3,2 m / 125.9"

Approximate weight (unpacked):

1,6 Kg / 3.5 lb

Technical information:

European version: Light source included
American version: Recommended light source (not included)
LED bulb: 3,4 W / 470 lm / 2700 K
E27 - E26 / Max. hgt. 105 mm / 4.1"

Suitable for indoor use.
Always use the light source recommended or equivalent.

Input voltage: 100, 120, 230 Vac.
(50 Hz / 60 Hz). According to destination

Regulations:

European version
UNE-EN 60598
UNE-EN 55015
UNE-EN 60529

American version
Dry location only
UL-153
E-352592

Asa

Miguel Milá. 1961
Table Lamps

Maintenance:

Clean with a smooth cloth. Do not use ammonia, solvents or abrasive cleaning products.

Others:

The lamp is delivered in one package.
The assembly instructions are delivered with the product.

Model:

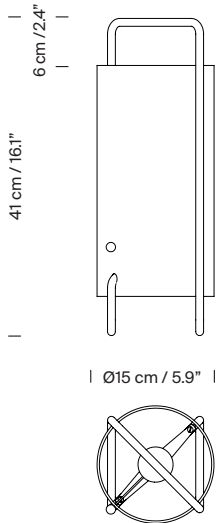

LIZA TABLE

Light Source: 1 X 12W E27 LED Filament Bulbs



Dimmable: not dimmable

Materials: Lentiflex®, Pewterflex®, Polycarbonate

Weight: net 3 Kg - gross 4,2 Kg

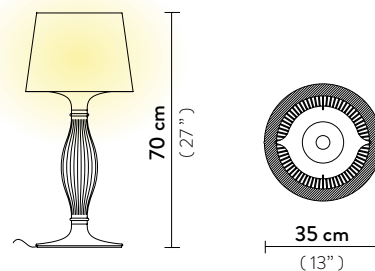
Packaging: 38 x 38 x h. 80 cm



FINISH	PRODUCT CODE	EAN CODE	DETAILS
 <p>PEWTER</p>	LIZTM00PWT000RE000EU	8024727103365	
 <p>PRISMA</p>	LIZTM00PRS000RE000EU	8024727103419	