

NOTICE

The purchaser agrees when purchasing this plan (the "Plan"):
 1) that the purchaser has acquired the right to build and construct the object of the plan set out in the Plan (the "Project") for his/her/its personal use only and not for any commercial use;
 2) that reproduction of the Plan in whole or in part by any means whatsoever is strictly prohibited;
 3) Blueprints For The Handyman shall not be liable for any willful misuse or negligent use of this plan, the Project, or any tools used to construct the Project, or for any loss or damage resulting therefrom. *

Note: Read all directions before beginning
 Carpenters Glue should be used to reinforce all joints
 Dimensions shown in brackets denote millimeters
 Set all nails, Countersink all screws.

Directions

- 1) Lay out your material on the workbench, as outlined in the suggested material layout (Fig. 1). Draw out all parts exactly as illustrated in cutting diagram (Fig. 2), including the letter designations, in pencil. Ensure to leave a small space between cut lines to allow for the width of the sawkerf and to give the work a smooth finish. Cut the parts in the correct sequence. Always cut on the waste side of the line. Cut the 3/4" rabbet for A & B with a router and guide. Chiseling out any all edges. Use the compass to draw the curves, the radii are given. Sand all edges.
- 2) Nail K to C as shown (Fig 3) with glue and 1 1/4" finishing nails.
- 3) Nail M and N to G as shown (Fig 4) with glue and 1 1/4" finishing nails. Nail N to M with 1 1/4" nails. Wipe off excess glue.
- 4) Nail P and J to E as shown (Fig 5) with glue and 1 1/4" finishing nails. Wipe off excess glue.
- 5) Nail J to F as shown (Fig 6) with glue and 1 1/4" finishing nails. Wipe off excess glue.
- 6) Nail L to H as shown (Fig 7) with glue and 1 1/4" finishing nails. Wipe off excess glue. On the underside, draw a line 2" from the front edge, and 3" from each edge for hinge guides. Attach hinges with the hinge pin along the 2" guide, and the outer edge of the hinge along the 3" guide.

OVER

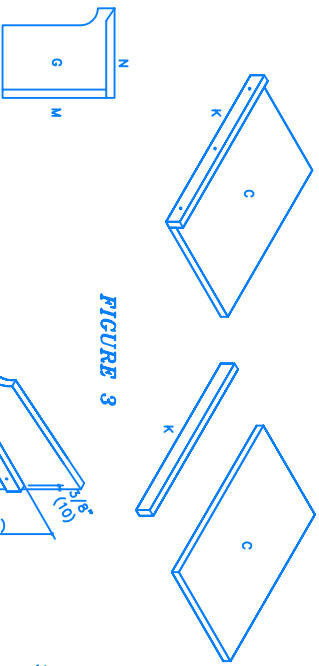

FIGURE 3

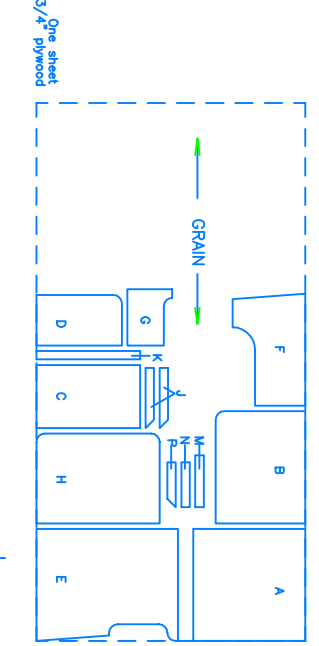

FIGURE 1
 MATERIALS LAYOUT

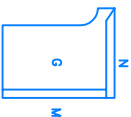

FIGURE 4

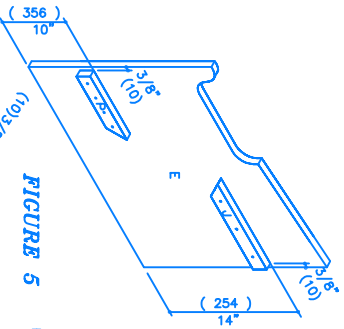

FIGURE 5

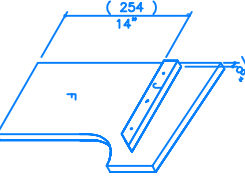

FIGURE 6

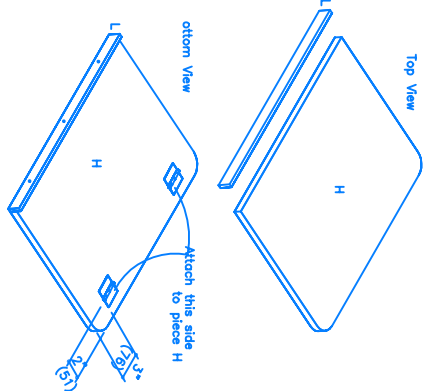
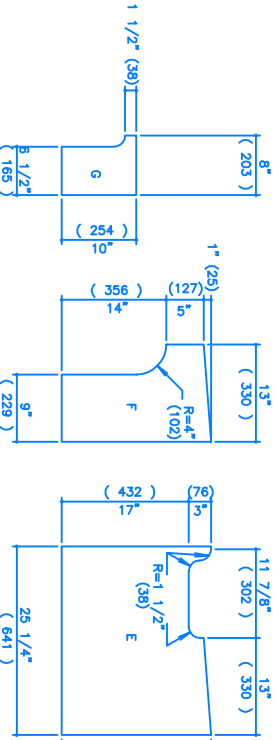

FIGURE 7

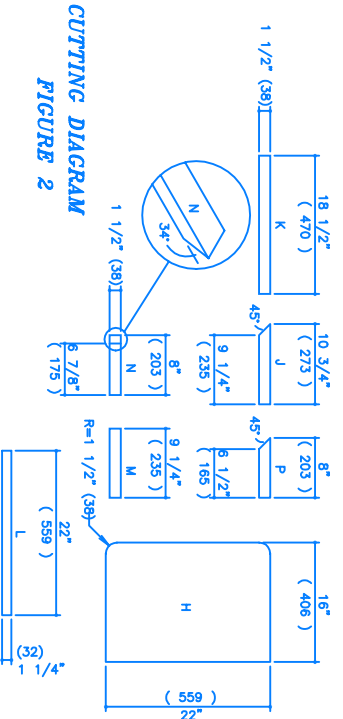

FIGURE 2
 CUTTING DIAGRAM

MATERIALS LIST

- Sandpaper
- Carpenters glue
- Six Nail guides
- Approx. 1/2 lb. 1 1/4" finishing nails
- Two Z hinges with countersink hardware

MATERIALS LIST

- One 4x8 sheet 3/4" plywood, good both sides
- Interior enamel paint
- One door stop 1 1/4"x3/8"x3"
- Approx. 1/2 lb. 2" finishing nails
- Wood fill

TOOLS

- Table Saw and Jigsaw
- Pencil and Measuring Tape
- 1/16", 1/8", 1/4", 3/8" drill bits
- Hammer and Screwdrivers
- Paintbrush and Putty Knife