

# Playhouse



Every child dreams of a place of their own. You can make those dreams come true with this backyard Playhouse. With one large open room and a front porch that's just the right size, it will provide hours of fun. Made from standard dimensional lumber, the simple panel construction techniques make this project as easy to build as it is fun.

**Playhouse Dimensions:**  
70" Wide x 94" Deep x  
88-1/2" High

## **Getting started:**

The parts for this project can be cut with a variety of tools and machines but we all have our favorites and those of which we are most comfortable. We suggest you read through the instructions before doing any cutting and decide which tools you feel most comfortable using. The plan is designed to guide you through the steps of building the project as we have.

## **A note about safety:**

Woodworking can be dangerous. Safety equipment and keeping your tools in proper working order with guards in place and adjusted properly can greatly reduce your risk of injury.

Be sure to read and understand all of the safety instructions that come with your tools.

Use common sense and caution in your workshop at all times. If you are not comfortable with a procedure, don't do it. Find an alternative that feels safe for you, no matter how others may work. Safety in your workshop is your responsibility.

## **Shop tips:**

We have a few helpful hints we would like to share with you that have made assembling projects easier for us and help you to have the same success and enjoyment.

Do not cut every piece at once. Especially on large, complex projects, cut and fit as you go through the procedures. Small dimensional discrepancies in one part such as slightly shallower dados or slightly longer tenons than what's called for can affect the dimensions of subsequent parts. Build complex projects as a series of components. These plans are designed to walk you through the procedures in a logical order and it is important to go through the steps and verify the dimensions given with what's already been built.

Predrilling is always a good idea in any type of wood that you use to avoid splitting or breaking off screw heads.

You can't say enough about squaring up assemblies no matter where you are in the assembly process. Getting something a little out of skew can be a frustrating experience for any woodworker. To avoid this always keep a tape measure and square handy. Remember to square before and after you have tightened the clamps.

# CUT LAYOUT

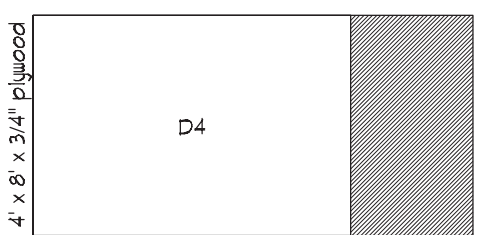
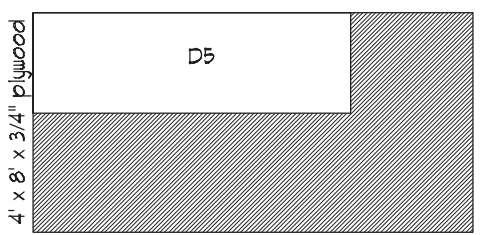
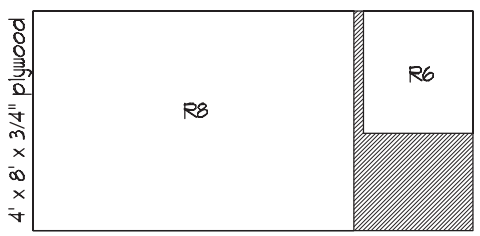
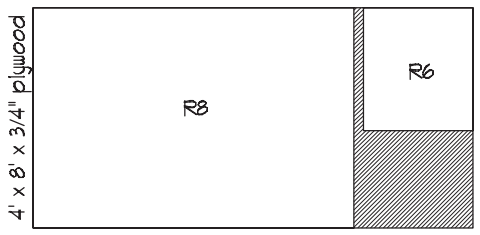
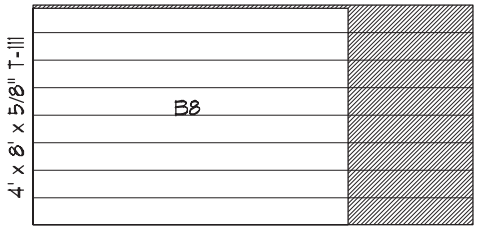
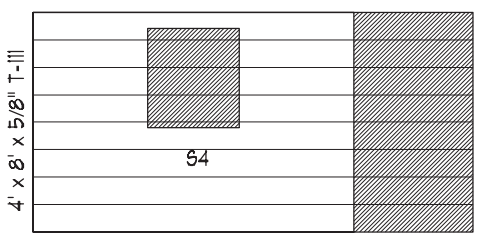
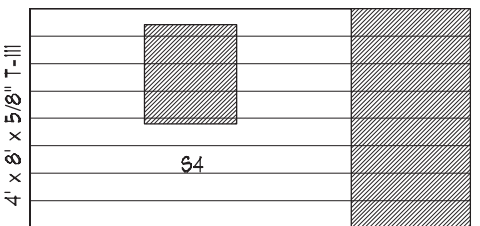
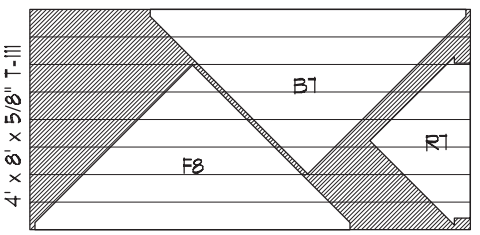
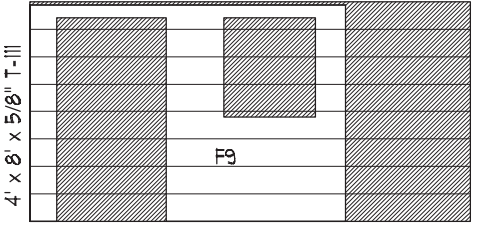
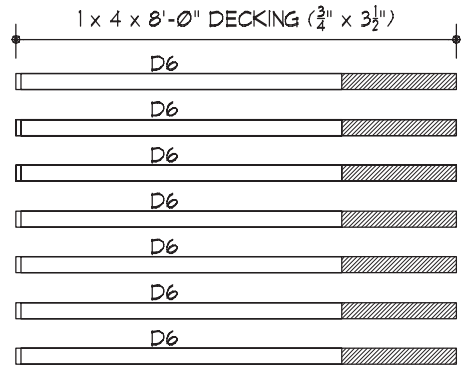
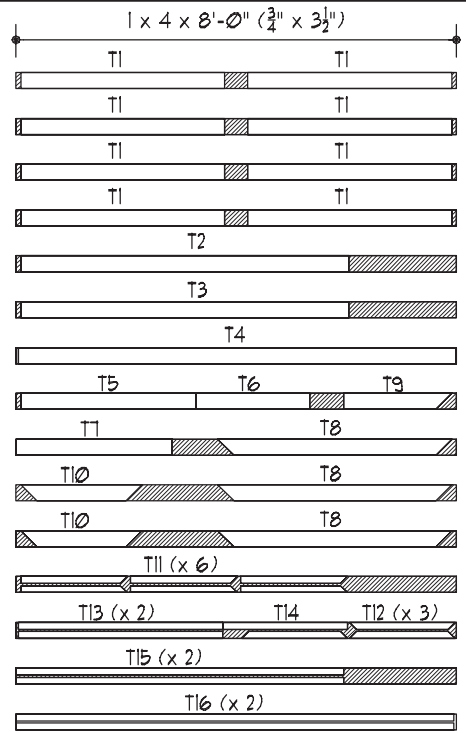
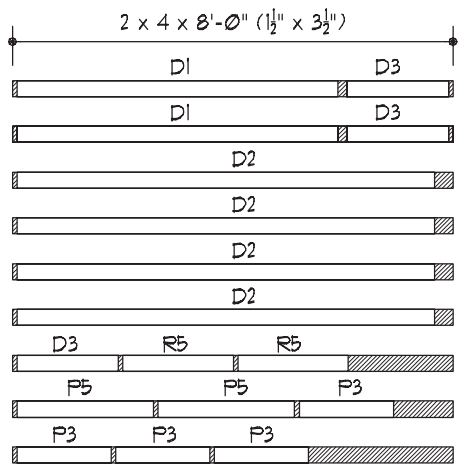
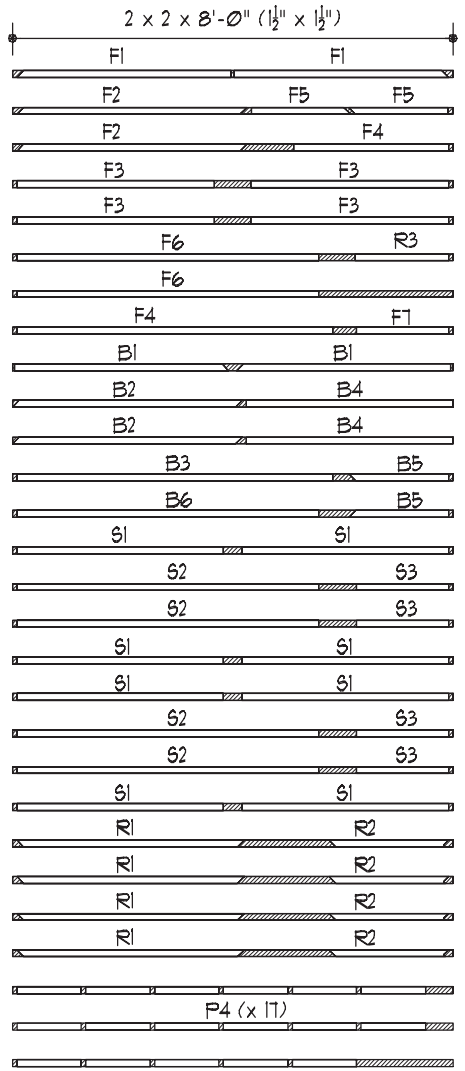
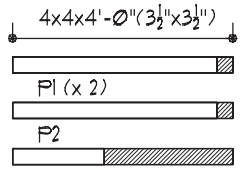

## PARTS LIST: (finished dimensions)

- F1. (2) 1-1/2" x 46-5/8" (FRONT FRAME)
- F2. (2) 1-1/2" x 50-1/8" (FRONT FRAME)
- F3. (4) 1-1/2" x 43" (FRONT FRAME)
- F4. (1) 1-1/2" x 68-3/4" (FRONT FRAME)
- F5. (2) 1-1/2" x 21-5/8" (FRONT FRAME)
- F6. (2) 1-1/2" x 65-3/4" (FRONT FRAME)
- F7. (1) 1-1/2" x 20" (FRONT FRAME)
- F8. (1) 35-7/8" x 68-3/4" (FRONT PANEL)
- F9. (1) 35-7/8" x 68-3/4" (FRONT PANEL)
- B1. (2) 1-1/2" x 46-5/8" (BACK FRAME)
- B2. (2) 1-1/2" x 50-1/8" (BACK FRAME)
- B3. (1) 1-1/2" x 68-3/4" (BACK FRAME)
- B4. (2) 1-1/2" x 45" (BACK FRAME)
- B5. (2) 1-1/2" x 21-5/8" (BACK FRAME)
- B6. (1) 1-1/2" x 65-3/4" (BACK FRAME)
- B7. (1) 35-7/8" x 68-3/4" (BACK PANEL)
- B8. (1) 47-1/4" x 68-3/4" (BACK PANEL)
- S1. (8) 1-1/2" x 45" (SIDE FRAME)
- S2. (4) 1-1/2" x 65-3/4" (SIDE FRAME)
- S3. (4) 1-1/2" x 20" (SIDE FRAME)
- S4. (2) 48" x 10" (SIDE PANELS)
- R1. (4) 1-1/2" x 49-1/2" (RAFTERS)
- R2. (4) 1-1/2" x 26" (PORCH RAFTERS)
- R3. (1) 1-1/2" x 20-1/4" (PORCH RIDGE)
- R4. (1) 1-1/2" x 33-3/4" (PORCH FRAME)
- R5. (2) 3-1/2" x 24" (PORCH FRAME)
- R6. (2) 26-3/4" x 24" (PORCH ROOF)
- RT. (1) 36-3/4" x 21-1/8" (PORCH GABLE)
- R8. (2) 48" x 10" (ROOF PANELS)
- P1. (2) 3-1/2" x 44-1/2" (LONG POST)
- P2. (1) 3-1/2" x 20" (SHORT POST)
- P3. (4) 3-1/2" x 20-1/2" (SHORT RAILS)
- P4. (17) 1-1/2" x 14" (SPINDLES)
- P5. (2) 3-1/2" x 29-3/4" (LONG RAILS)
- D1. (2) 3-1/2" x 10" (DECK FRAME)
- D2. (4) 3-1/2" x 91" (DECK FRAME)
- D3. (3) 3-1/2" x 22-1/8" (DECK FRAME)
- D4. (1) 48" x 69-1/4" (FLOOR PANEL)
- D5. (1) 22" x 69-1/4" (FLOOR PANEL)
- D6. (7) 3-1/2" x 10" (PORCH DECKING)
- T1. (8) 3-1/2" x 44-1/2" (CORNER BOARDS)
- T2. (1) 3-1/2" x 11-1/2" (FRIEZE TRIM)
- T3. (1) 3-1/2" x 11-1/2" (FRIEZE TRIM)
- T4. (1) 3-1/2" x 95-1/2" (FRIEZE TRIM)
- T5. (1) 3-1/2" x 38-1/4" (FRIEZE TRIM)
- T6. (1) 3-1/2" x 24-3/4" (FRIEZE TRIM)
- T7. (1) 3-1/2" x 34" (FRIEZE TRIM)
- T8. (3) 3-1/2" x 51" (GABLE TRIM)
- T9. (1) 3-1/2" x 23-1/2" (GABLE TRIM)
- T10. (2) 3-1/2" x 26-1/2" (PORCH TRIM)
- T11. (6) 1-1/2" x 23-1/4" (WINDOW TRIM)
- T12. (3) 1-1/2" x 23" (WINDOW TRIM)
- T13. (2) 1-1/2" x 44-1/2" (DOOR TRIM)
- T14. (1) 1-1/2" x 27" (DOOR TRIM)
- T15. (2) 1-1/2" x 11-1/2" (DECK TRIM)
- T16. (2) 1-1/2" x 95-1/2" (DECK TRIM)

## MATERIALS LIST:

- (3) 4 x 4 x 48"
- (28) 2 x 2 x 96"
- (9) 2 x 4 x 96"
- (15) 1 x 4 x 96"
- (7) 1 x 4 x 96" decking
- (5) 4' x 8' x 5/8" T-III siding
- (4) 4' x 8' x 3/4" plywood

## HARDWARE LIST:

- #8 x 3" galv. screws
- #8 x 2-1/2" galv. screws
- #8 x 2" galv. screws
- 1-1/2" galv. finish nails
- roofing nails
- (6) 4x8x16 patio blocks
- 60 sq. ft. shingles
- 40 ft. metal drip edge
- (1) decorative post cap

## BEFORE CONSTRUCTION BEGINS

The construction of this project requires careful planning and measuring during all phases of assembly. The more careful you are during the initial layout of the base, the easier the project will proceed and the more satisfying the results.

Always double check measurements given in this plan against the actual construction before cutting any wood. On a project this large, you cannot cut all the pieces at once and expect them to go together perfectly.

Use only corrosion resistant (galvanized) hardware and fasteners.

## DIAG. 1. CONSTRUCT DECK

1 Cut the deck frame pieces (D1 - D3) to length from treated 2x4 stock. Assemble the pieces as shown with 2-1/2" galvanized deck screws. Assemble frame in the desired yard location on level concrete patio blocks.

2 Double check the deck framing for square by measuring the diagonals. When the diagonal measurements are equal, the framing is square. Cut the floor panels (D4 & D5) and fasten to the deck frame with 1-1/2" galv. decking nails. The edges of the floor panels should lap the framing at least 3/4" on all sides.

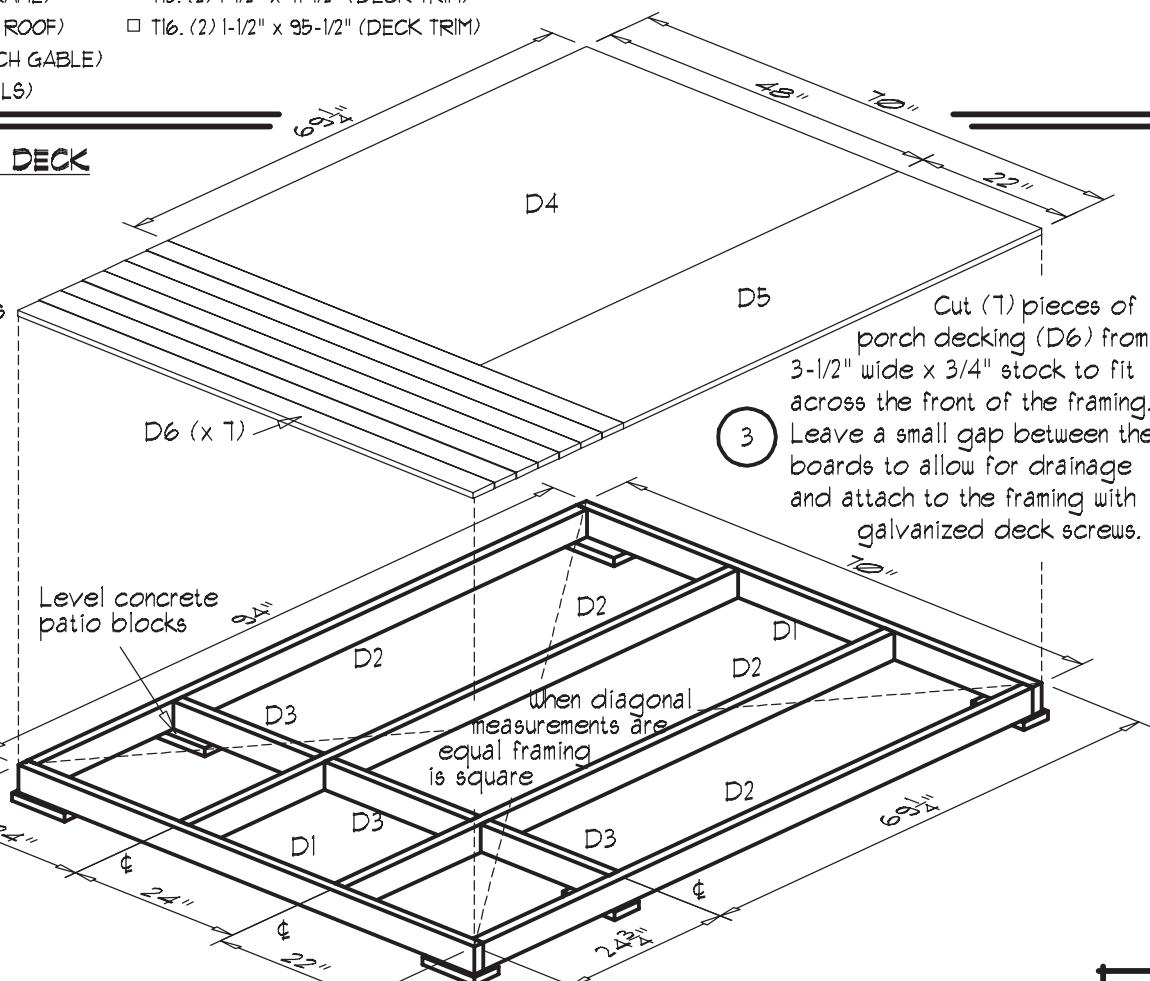

### DIAG 2. CONSTRUCT FRONT WALL

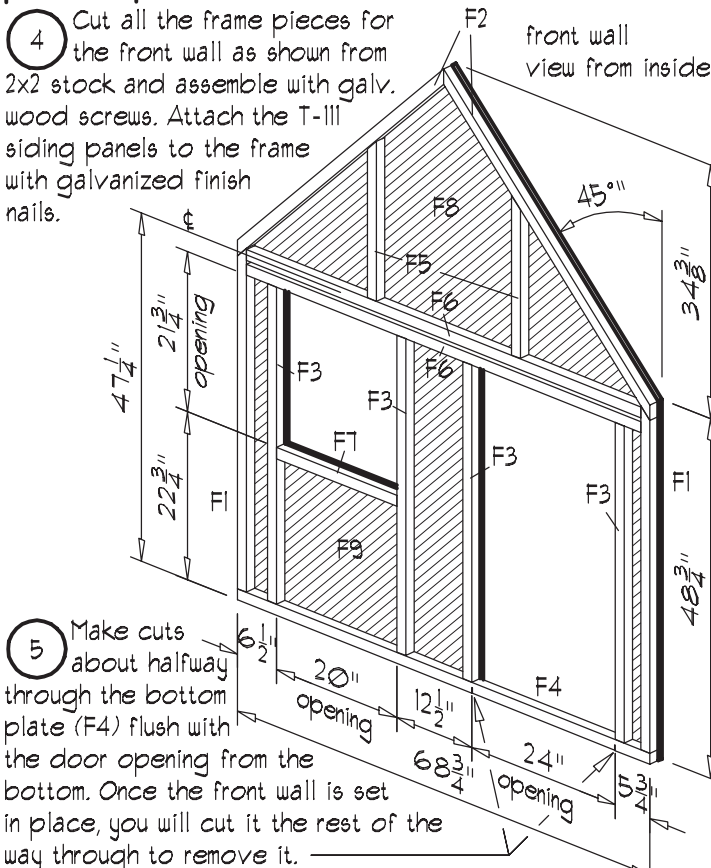

### DIAG 4. MAKE SIDE PANELS

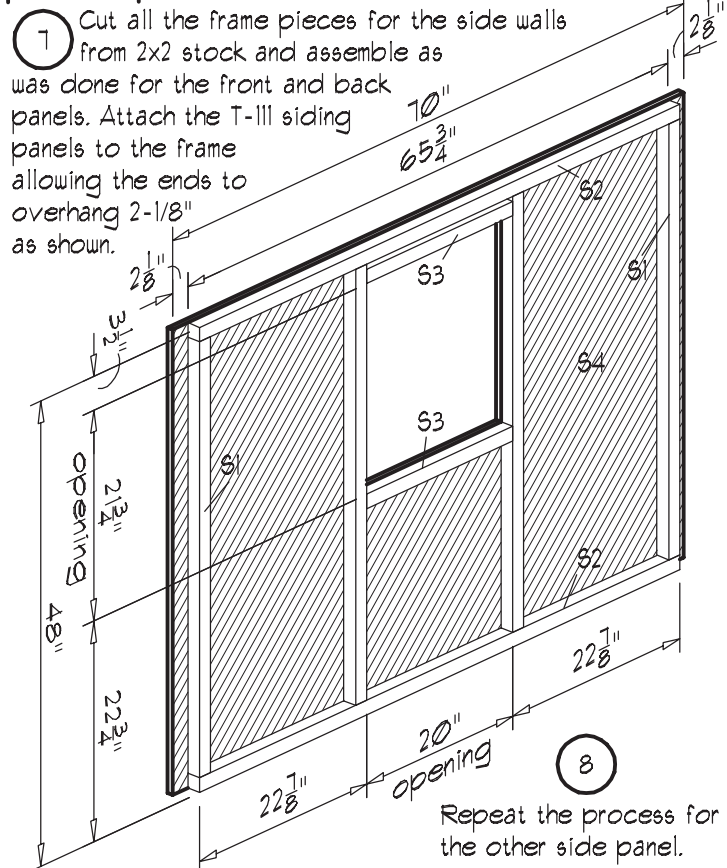

### DIAG 3. CONSTRUCT BACK WALL

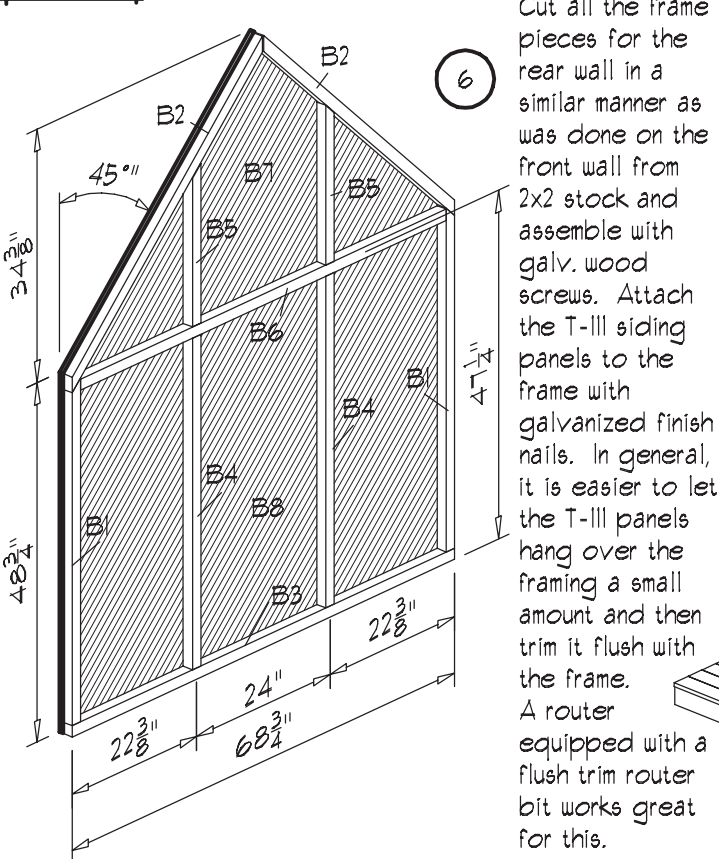

### DIAG 5. ASSEMBLE WALLS

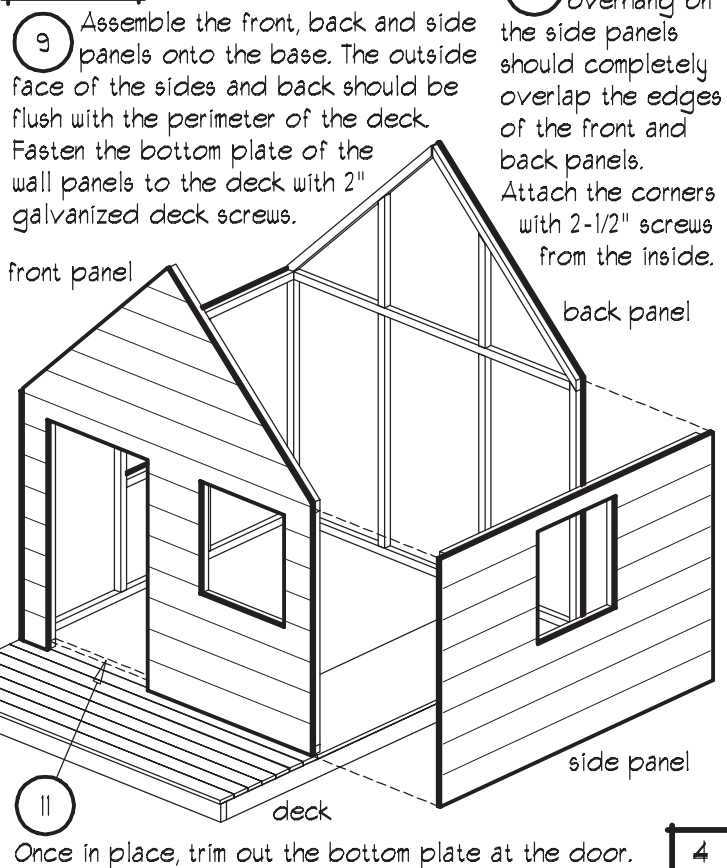

## DIAG 6. ROOF AND PORCH FRAMING

12 Cut (4) main rafters (R1) 49-1/2" long from 2x2 stock with 45 degree miters on each end. Assemble each pair together at the peak with a 2-1/2" galv. wood screw. Attach each assembly to the side walls centering them over the side wall studs as shown with 2-1/2" galv. wood screws.

13 Cut (2) long posts (P1) 44-1/2" long and (1) short post (P2) 20" long from 4x4 stock. Position the posts as shown flush with the edge of the deck. Secure the posts to the deck by toe nailing with 3" galv. wood screws on all four sides.

14 Cut (2) side porch frame pieces (R5) 24" long from 2x4 stock. Attach the frame pieces to the top of the posts, level them and attach them to the front wall from the inside. Be sure to maintain the spacing front to back when attaching the pieces.

15 Cut (1) front porch frame piece (R4) 33-3/4" long from 2x2 stock. Attach the frame piece to the top of the posts between the side frames as shown. Set the front frame piece back 5/8" from the front face of the posts.

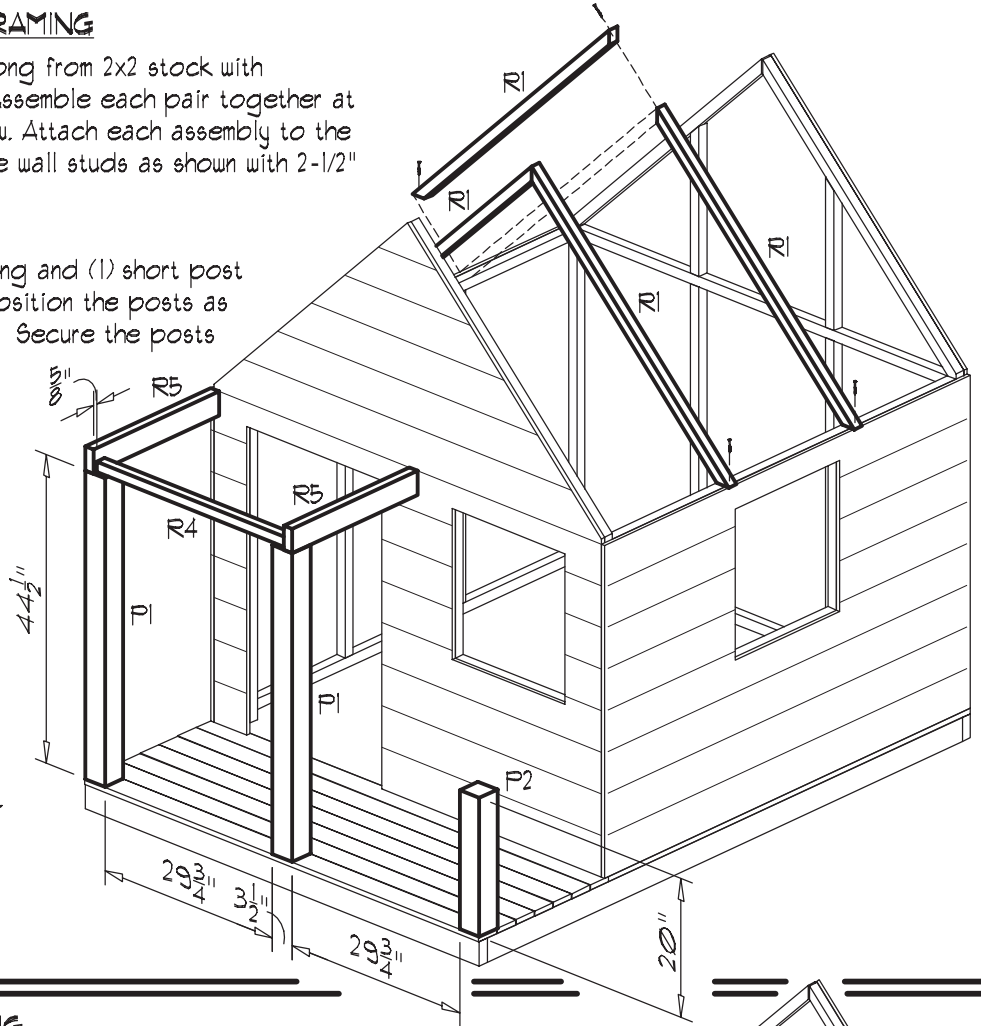

## DIAG 7. PORCH ROOF FRAMING

16 Cut (4) porch rafters (R2) 26" long from 2x2 stock as shown. Assemble the rafters in pairs as was done with the main rafters. Attach the rafters to the side porch frame with one assembly on each end. Attach one rafter assembly directly to the front wall panel from the inside.

17 Cut (1) porch ridge (R3) 20-1/4" long from 2x2 stock and fasten between the porch rafters peaks.

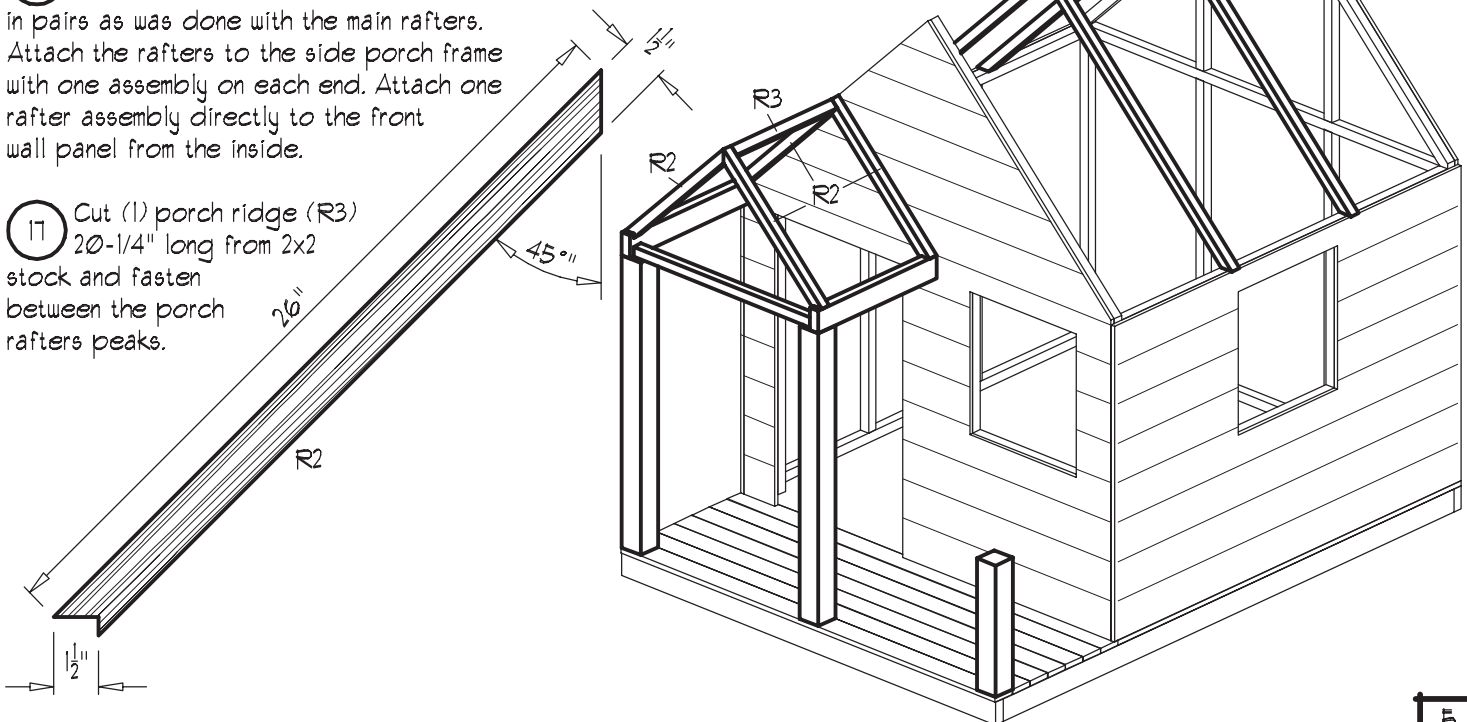

### DIAG 8. MAKE AND ATTACH ROOF PANELS

18 Measure and cut the roof panels (R8) and porch roof panels (R6) to fit from 3/4" plywood. Cut the porch gable (R7) from 5/8" T-III. Attach all the pieces with 1-1/2" galv. finish nails at 6" to 8" on center.

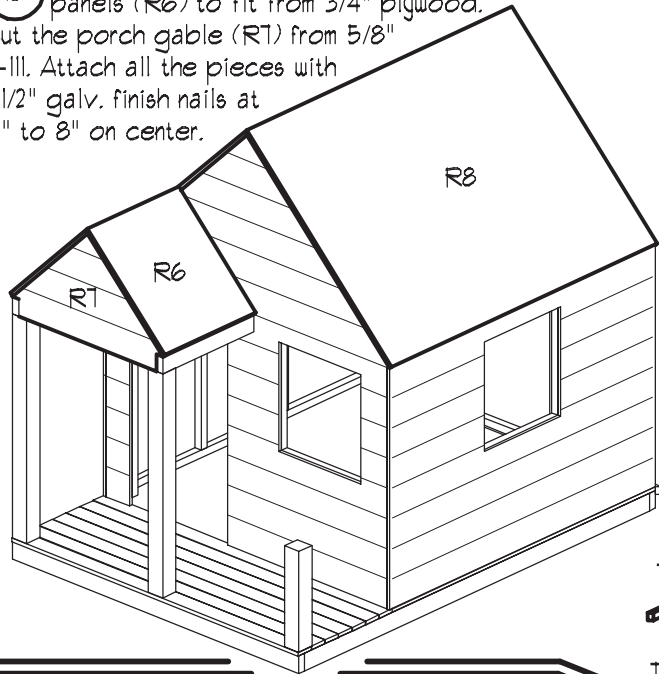

### DIAG 9. ATTACH DECK AND FRIEZE TRIM

19 Measure and cut to fit the frieze trim pieces (T2 thru T7) from 1x4 stock. The frieze pieces should be mounted so that the bottom edge is flush with the window openings and the lower side of the porch framing. Measure and cut the deck trim (T15 & T16) from 3/4" stock to fit mitering the ends at 45 degrees. Attach the trim to conceal the exposed flooring edges.

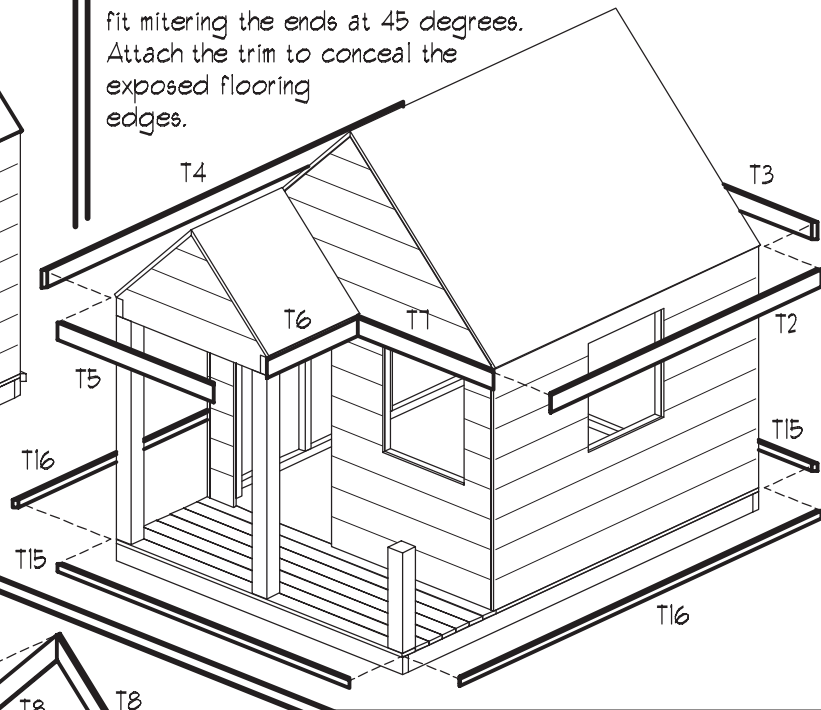

### DIAG 10. FINAL ASSEMBLY

20 Cut the corner trim pieces (T1) and gable trim pieces (T8 thru T10) to fit from 1x4 stock. All the trim pieces will have either 90 or 45 degree end cuts. Cut the window and door trim (T11 thru T14) from 1-1/2" wide stock. Attach with 1-1/2" galvanized finish nails.

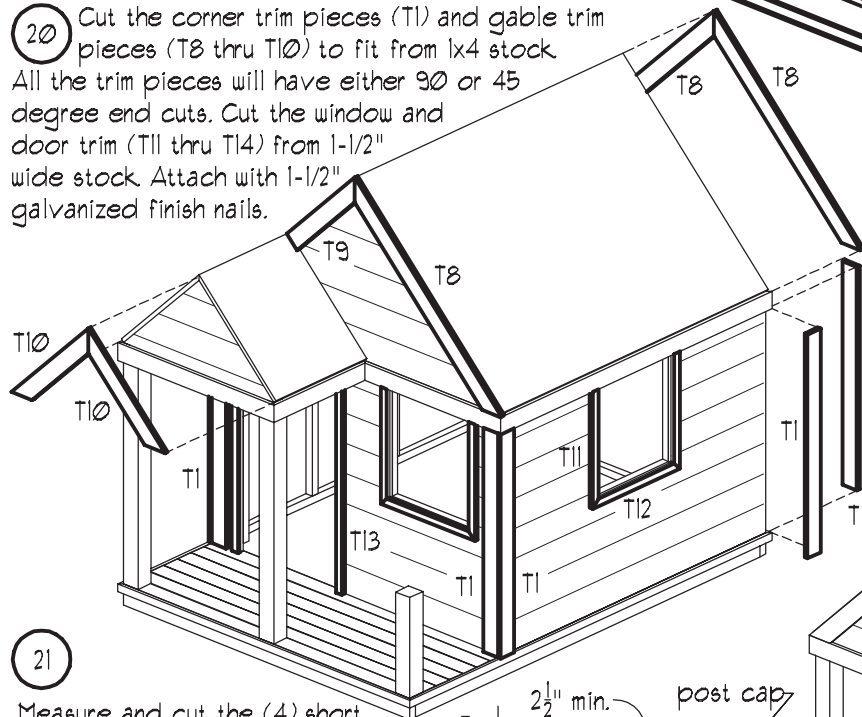

22 Edge the roof panels with metal drip flashing all around. Shape the edges to avoid sharp edges at the corners. Shingle the roof with either fiberglass shingles or wood shakes as desired.

Attach a pre-made post cap to the top of the short post to finish it off. Prime and paint all of the exposed wood with a good quality exterior paint in the colors desired.

21 Measure and cut the (4) short porch rails (P3) to fit between the corner posts and the front wall and (2) long porch rails to fit from 2x4 stock. Cut (17) spindles (P4) 14" long from 2x2 stock. Use 2" wide x 3/4" scrap pieces to wrap the bottom of each post to finish it off.

