

# Ninja Multiplication

4<sup>th</sup>  
Grade

$1 \times 4$

$1 \times 5$

$1 \times 6$

$1 \times 7$

$1 \times 8$

$1 \times 9$

$1 \times 12$

$2 \times 3$



# Table of Contents

---

## **Ninja Multiplication**



















Multiplication Flash Cards  
Ninja Multiplication: Multiplying by 7 \*  
Ninja Multiplication: Multiplying by 8 \*  
Ninja Multiplication: Multiplying by 9 \*  
2-Digit Multiplication #1 \*  
2-Digit Multiplication #2 \*  
Ninja Word Hunt #1 \*  
Ninja Word Hunt #2 \*  
Ninja Word Problems #1 \*  
Ninja Word Problems #2 \*  
How To Do Lattice Multiplication  
Lattice Multiplication #1 \*  
Lattice Multiplication #2 \*  
Lattice Multiplication #3 \*  
Multiplication Table  
Multiplication Table 30x30

*Certificate of Completion*  
*Answer Sheets*

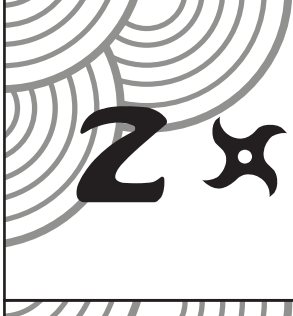
\* *Has an Answer Sheet*

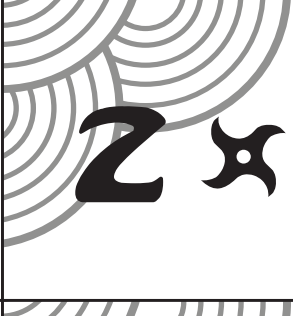
Want more workbooks? Join [Education.com Plus](http://www.education.com/education-plus/) to save time and money.  
<http://www.education.com/education-plus/>

Cut out each card. Write each answer on the back of the card lightly in pencil.

 $1 \times 1$	 $1 \times 2$	 $1 \times 3$
 $1 \times 4$	 $1 \times 5$	 $1 \times 6$
 $1 \times 7$	 $1 \times 8$	 $1 \times 9$
 $1 \times 10$	 $1 \times 11$	 $1 \times 12$
 $2 \times 1$	 $2 \times 2$	 $2 \times 3$
 $2 \times 4$	 $2 \times 5$	 $2 \times 6$

Cut out each card. Write each answer on the back of the card lightly in pencil.

 $2 \times 7$

 $2 \times 8$

 $2 \times 9$

 $2 \times 10$

 $2 \times 11$

 $2 \times 12$

 $3 \times 1$

 $3 \times 2$

 $3 \times 3$

 $3 \times 4$

 $3 \times 5$

 $3 \times 6$

 $3 \times 7$

 $3 \times 8$

 $3 \times 9$

 $3 \times 10$

 $3 \times 11$

 $3 \times 12$

Cut out each card. Write each answer on the back of the card lightly in pencil.

$4 \times 1$

$4 \times 2$

$4 \times 3$

$4 \times 4$

$4 \times 5$

$4 \times 6$

$4 \times 7$

$4 \times 8$

$4 \times 9$

$4 \times 10$

$4 \times 11$

$4 \times 12$

$5 \times 1$

$5 \times 2$











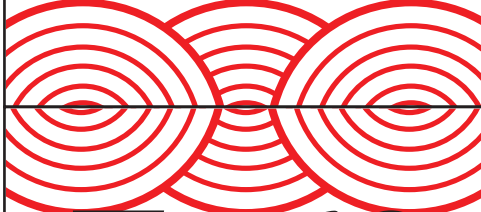
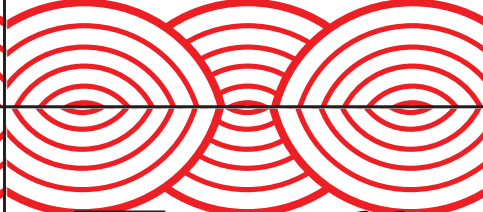
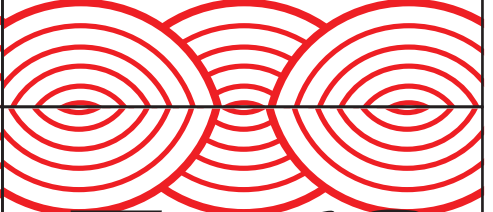

$5 \times 3$

$5 \times 4$

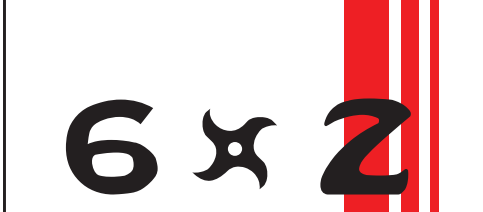
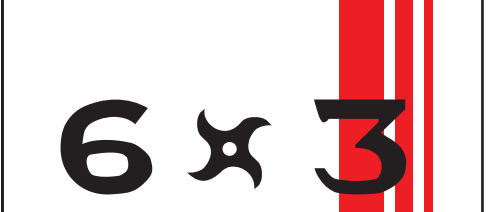
$5 \times 5$

$5 \times 6$

Cut out each card. Write each answer on the back of the card lightly in pencil.

 <b>5 x 7</b>	 <b>5 x 8</b>	 <b>5 x 9</b>
 <b>5 x 10</b>	 <b>5 x 11</b>	 <b>5 x 12</b>
 <b>6 x 1</b>	 <b>6 x 2</b>	 <b>6 x 3</b>
 <b>6 x 4</b>	 <b>6 x 5</b>	 <b>6 x 6</b>
 <b>6 x 7</b>	 <b>6 x 8</b>	 <b>6 x 9</b>
 <b>6 x 10</b>	 <b>6 x 11</b>	 <b>6 x 12</b>

Cut out each card. Write each answer on the back of the card lightly in pencil.

$7 \times 1$

$7 \times 2$

$7 \times 3$

$7 \times 4$

$7 \times 5$

$7 \times 6$

$7 \times 7$

$7 \times 8$

$7 \times 9$

$7 \times 10$

$7 \times 11$

$7 \times 12$

$8 \times 1$

$8 \times 2$

$8 \times 3$

$8 \times 4$

$8 \times 5$

$8 \times 6$

Cut out each card. Write each answer on the back of the card lightly in pencil.

$8 \times 7$

$8 \times 8$

$8 \times 9$

$8 \times 10$

$8 \times 11$

$8 \times 12$

$9 \times 1$

$9 \times 2$

$9 \times 3$

$9 \times 4$

$9 \times 5$

$9 \times 6$

$9 \times 7$

$9 \times 8$













$9 \times 9$

$9 \times 10$

$9 \times 11$

$9 \times 12$

Cut out each card. Write each answer on the back of the card lightly in pencil.

<del><math>10 \times 1</math></del>	<del><math>10 \times 2</math></del>	<del><math>10 \times 3</math></del>
<del><math>10 \times 4</math></del>	<del><math>10 \times 5</math></del>	<del><math>10 \times 6</math></del>
<del><math>10 \times 7</math></del>	<del><math>10 \times 8</math></del>	<del><math>10 \times 9</math></del>
<del><math>10 \times 10</math></del>	<del><math>10 \times 11</math></del>	<del><math>10 \times 12</math></del>
		
$11 \times 1$	$11 \times 2$	$11 \times 3$
		
		
$11 \times 4$	$11 \times 5$	$11 \times 6$
		

Cut out each card. Write each answer on the back of the card lightly in pencil.

 $11 \times 7$ 

 $11 \times 8$ 

 $11 \times 9$ 

 $11 \times 10$ 

 $11 \times 11$ 

 $11 \times 12$ 

 $12 \times 1$ 

 $12 \times 2$ 

 $12 \times 3$ 

 $12 \times 4$ 

 $12 \times 5$ 

 $12 \times 6$ 

 $12 \times 7$ 

 $12 \times 8$ 

 $12 \times 9$ 

 $12 \times 10$ 

 $12 \times 11$ 

 $12 \times 12$ 



# NINJA MULTIPLICATION

## \* MULTIPLYING BY 7 \*

Master your multiplication skills by completing each equation.



$$\begin{array}{r} 2 \\ \times 7 \\ \hline \end{array}$$

$$\begin{array}{r} 10 \\ \times 7 \\ \hline \end{array}$$

$$\begin{array}{r} 3 \\ \times 7 \\ \hline \end{array}$$

$$\begin{array}{r} 15 \\ \times 7 \\ \hline \end{array}$$

$$\begin{array}{r} 6 \\ \times 7 \\ \hline \end{array}$$

$$\begin{array}{r} 7 \\ \times 7 \\ \hline \end{array}$$

$$\begin{array}{r} 4 \\ \times 7 \\ \hline \end{array}$$

$$\begin{array}{r} 11 \\ \times 7 \\ \hline \end{array}$$

$$\begin{array}{r} 8 \\ \times 7 \\ \hline \end{array}$$

$$\begin{array}{r} 13 \\ \times 7 \\ \hline \end{array}$$

$$\begin{array}{r} 1 \\ \times 7 \\ \hline \end{array}$$

$$\begin{array}{r} 20 \\ \times 7 \\ \hline \end{array}$$

$$\begin{array}{r} 12 \\ \times 7 \\ \hline \end{array}$$

$$\begin{array}{r} 18 \\ \times 7 \\ \hline \end{array}$$

$$\begin{array}{r} 9 \\ \times 7 \\ \hline \end{array}$$

$$\begin{array}{r} 14 \\ \times 7 \\ \hline \end{array}$$

$$\begin{array}{r} 22 \\ \times 7 \\ \hline \end{array}$$

$$\begin{array}{r} 16 \\ \times 7 \\ \hline \end{array}$$

$$\begin{array}{r} 5 \\ \times 7 \\ \hline \end{array}$$

$$\begin{array}{r} 17 \\ \times 7 \\ \hline \end{array}$$



# NINJA MULTIPLICATION

## \* MULTIPLYING BY 8 \*

Master your multiplication skills by completing each equation.



$$\begin{array}{r} 3 \\ \times 8 \\ \hline \square \end{array}$$

$$\begin{array}{r} 14 \\ \times 8 \\ \hline \square \end{array}$$

$$\begin{array}{r} 9 \\ \times 8 \\ \hline \square \end{array}$$

$$\begin{array}{r} 20 \\ \times 8 \\ \hline \square \end{array}$$

$$\begin{array}{r} 2 \\ \times 8 \\ \hline \square \end{array}$$

$$\begin{array}{r} 10 \\ \times 8 \\ \hline \square \end{array}$$

$$\begin{array}{r} 13 \\ \times 8 \\ \hline \square \end{array}$$

$$\begin{array}{r} 7 \\ \times 8 \\ \hline \square \end{array}$$

$$\begin{array}{r} 8 \\ \times 8 \\ \hline \square \end{array}$$

$$\begin{array}{r} 6 \\ \times 8 \\ \hline \square \end{array}$$

$$\begin{array}{r} 12 \\ \times 8 \\ \hline \square \end{array}$$

$$\begin{array}{r} 16 \\ \times 8 \\ \hline \square \end{array}$$

$$\begin{array}{r} 21 \\ \times 8 \\ \hline \square \end{array}$$

$$\begin{array}{r} 1 \\ \times 8 \\ \hline \square \end{array}$$

$$\begin{array}{r} 5 \\ \times 8 \\ \hline \square \end{array}$$

$$\begin{array}{r} 4 \\ \times 8 \\ \hline \square \end{array}$$

$$\begin{array}{r} 19 \\ \times 8 \\ \hline \square \end{array}$$

$$\begin{array}{r} 11 \\ \times 8 \\ \hline \square \end{array}$$

$$\begin{array}{r} 15 \\ \times 8 \\ \hline \square \end{array}$$

$$\begin{array}{r} 17 \\ \times 8 \\ \hline \square \end{array}$$



# NINJA MULTIPLICATION

## \* MULTIPLYING BY 9 \*

Master your multiplication skills by completing each equation.



$$\begin{array}{r} 5 \\ \times 9 \\ \hline \square \end{array}$$

$$\begin{array}{r} 12 \\ \times 9 \\ \hline \square \end{array}$$

$$\begin{array}{r} 3 \\ \times 9 \\ \hline \square \end{array}$$

$$\begin{array}{r} 20 \\ \times 9 \\ \hline \square \end{array}$$

$$\begin{array}{r} 4 \\ \times 9 \\ \hline \square \end{array}$$

$$\begin{array}{r} 10 \\ \times 9 \\ \hline \square \end{array}$$

$$\begin{array}{r} 13 \\ \times 9 \\ \hline \square \end{array}$$

$$\begin{array}{r} 7 \\ \times 9 \\ \hline \square \end{array}$$

$$\begin{array}{r} 14 \\ \times 9 \\ \hline \square \end{array}$$

$$\begin{array}{r} 1 \\ \times 9 \\ \hline \square \end{array}$$

$$\begin{array}{r} 19 \\ \times 9 \\ \hline \square \end{array}$$

$$\begin{array}{r} 0 \\ \times 9 \\ \hline \square \end{array}$$

$$\begin{array}{r} 9 \\ \times 9 \\ \hline \square \end{array}$$

$$\begin{array}{r} 11 \\ \times 9 \\ \hline \square \end{array}$$

$$\begin{array}{r} 6 \\ \times 9 \\ \hline \square \end{array}$$

$$\begin{array}{r} 8 \\ \times 9 \\ \hline \square \end{array}$$

$$\begin{array}{r} 16 \\ \times 9 \\ \hline \square \end{array}$$

$$\begin{array}{r} 2 \\ \times 9 \\ \hline \square \end{array}$$

$$\begin{array}{r} 18 \\ \times 9 \\ \hline \square \end{array}$$

$$\begin{array}{r} 15 \\ \times 9 \\ \hline \square \end{array}$$

# 2-DIGIT MULTIPLICATION



$$\begin{array}{r} 27 \\ \times 3 \\ \hline 81 \end{array}$$

$$\begin{array}{r} 65 \\ \times 9 \\ \hline 585 \end{array}$$



MULTIPLY. REGROUP IF NEEDED.

$$\begin{array}{r} 77 \\ \times 9 \\ \hline \end{array}$$

$$\begin{array}{r} 19 \\ \times 6 \\ \hline \end{array}$$

$$\begin{array}{r} 24 \\ \times 8 \\ \hline \end{array}$$

$$\begin{array}{r} 90 \\ \times 7 \\ \hline \end{array}$$

$$\begin{array}{r} 36 \\ \times 5 \\ \hline \end{array}$$

$$\begin{array}{r} 21 \\ \times 6 \\ \hline \end{array}$$

$$\begin{array}{r} 82 \\ \times 4 \\ \hline \end{array}$$

$$\begin{array}{r} 78 \\ \times 9 \\ \hline \end{array}$$

$$\begin{array}{r} 63 \\ \times 9 \\ \hline \end{array}$$

$$\begin{array}{r} 58 \\ \times 2 \\ \hline \end{array}$$

$$\begin{array}{r} 61 \\ \times 4 \\ \hline \end{array}$$

$$\begin{array}{r} 38 \\ \times 9 \\ \hline \end{array}$$

$$\begin{array}{r} 13 \\ \times 7 \\ \hline \end{array}$$

$$\begin{array}{r} 52 \\ \times 5 \\ \hline \end{array}$$

$$\begin{array}{r} 99 \\ \times 5 \\ \hline \end{array}$$

$$\begin{array}{r} 46 \\ \times 7 \\ \hline \end{array}$$

$$\begin{array}{r} 29 \\ \times 8 \\ \hline \end{array}$$

$$\begin{array}{r} 98 \\ \times 3 \\ \hline \end{array}$$

$$\begin{array}{r} 23 \\ \times 7 \\ \hline \end{array}$$

$$\begin{array}{r} 72 \\ \times 3 \\ \hline \end{array}$$

$$\begin{array}{r} 25 \\ \times 6 \\ \hline \end{array}$$

$$\begin{array}{r} 68 \\ \times 8 \\ \hline \end{array}$$

$$\begin{array}{r} 43 \\ \times 8 \\ \hline \end{array}$$

$$\begin{array}{r} 52 \\ \times 3 \\ \hline \end{array}$$

$$\begin{array}{r} 75 \\ \times 9 \\ \hline \end{array}$$



# 2-DIGIT MULTIPLICATION



$$\begin{array}{r} 85 \\ \times 13 \\ \hline 255 \\ + 850 \\ \hline 1105 \end{array}$$

$$\begin{array}{r} 95 \\ \times 38 \\ \hline 760 \\ + 2850 \\ \hline 3610 \end{array}$$



MULTIPLY. REGROUP IF NEEDED.

$$\begin{array}{r} 97 \\ \times 30 \\ \hline \end{array}$$

$$\begin{array}{r} 58 \\ \times 46 \\ \hline \end{array}$$

$$\begin{array}{r} 85 \\ \times 34 \\ \hline \end{array}$$

$$\begin{array}{r} 72 \\ \times 47 \\ \hline \end{array}$$

$$\begin{array}{r} 97 \\ \times 18 \\ \hline \end{array}$$

$$\begin{array}{r} 46 \\ \times 21 \\ \hline \end{array}$$

$$\begin{array}{r} 92 \\ \times 38 \\ \hline \end{array}$$

$$\begin{array}{r} 44 \\ \times 12 \\ \hline \end{array}$$

$$\begin{array}{r} 83 \\ \times 49 \\ \hline \end{array}$$

$$\begin{array}{r} 62 \\ \times 29 \\ \hline \end{array}$$

$$\begin{array}{r} 81 \\ \times 51 \\ \hline \end{array}$$

$$\begin{array}{r} 47 \\ \times 29 \\ \hline \end{array}$$

$$\begin{array}{r} 65 \\ \times 23 \\ \hline \end{array}$$

$$\begin{array}{r} 58 \\ \times 25 \\ \hline \end{array}$$

$$\begin{array}{r} 47 \\ \times 32 \\ \hline \end{array}$$

# NINJA WORD HUNT

Learn the ways of the ninja! Uncover the mysteries of the ninja by encoding the answer to the question below. Solve the following multiplication equations then match each answer to its own letter.

**\* What does "Ninjitsu" mean? \***

<b>A</b>	<b>B</b>	<b>C</b>	<b>D</b>	<b>E</b>	<b>F</b>	<b>G</b>	<b>H</b>	<b>I</b>	<b>J</b>	<b>K</b>	<b>L</b>	<b>M</b>
1	2	3	4	5	6	7	8	9	10	11	12	13
<b>N</b>	<b>O</b>	<b>P</b>	<b>Q</b>	<b>R</b>	<b>S</b>	<b>T</b>	<b>U</b>	<b>V</b>	<b>W</b>	<b>X</b>	<b>Y</b>	<b>Z</b>
14	15	16	17	18	19	20	21	22	23	24	25	26

Example:  $19 \times 164 = \frac{3}{1} \frac{1}{2} \frac{18}{3} \rightarrow \frac{C}{1} \frac{A}{2} \frac{P}{3}$

$$2 \times 59 = \frac{\quad}{1} \frac{\quad}{2}$$

$$2 \times 5 \times 2 = \frac{\quad}{3}$$

$$12 \times 13 = \frac{\quad}{4} \frac{\quad}{5}$$

$$30 \times 64 = \frac{\quad}{6} \frac{\quad}{7}$$

$$213 \times 24 = \frac{\quad}{8} \frac{\quad}{9} \frac{\quad}{10}$$

$$26 \times 8 = \frac{\quad}{11} \frac{\quad}{12}$$

**"Ninjitsu" means:**

# NINJA WORD HUNT

Learn the ways of the ninja! Uncover the mysteries of the ninja by encoding the answer to the question below. Solve the following multiplication equations then match each answer to its own letter.

**What's the most common ninja weapon?**

<b>A</b>	<b>B</b>	<b>C</b>	<b>D</b>	<b>E</b>	<b>F</b>	<b>G</b>	<b>H</b>	<b>I</b>	<b>J</b>	<b>K</b>	<b>L</b>	<b>M</b>
1	2	3	4	5	6	7	8	9	10	11	12	13
<b>N</b>	<b>O</b>	<b>P</b>	<b>Q</b>	<b>R</b>	<b>S</b>	<b>T</b>	<b>U</b>	<b>V</b>	<b>W</b>	<b>X</b>	<b>Y</b>	<b>Z</b>
14	15	16	17	18	19	20	21	22	23	24	25	26

Example:  $19 \times 164 = \frac{3}{1} \frac{1}{2} \frac{18}{3} \rightarrow \frac{C}{1} \frac{A}{2} \frac{P}{3}$

$$52 \times 4 = \frac{\quad}{1} \frac{\quad}{2}$$

$$121 \times 15 = \frac{\quad}{3} \frac{\quad}{4}$$

$$23 \times 1 = \frac{\quad}{5}$$

$$457 \times 2 = \frac{\quad}{6} \frac{\quad}{7}$$

$$353 \times 2 + 13 = \frac{\quad}{8} \frac{\quad}{9}$$

$$67 \times 3 = \frac{\quad}{10} \frac{\quad}{11}$$

$$450 \times 4 + 19 = \frac{\quad}{12} \frac{\quad}{13}$$

**Ninjas always carry:**

1 2 3 4 5 6 7 8 9 10 11 12 13



**Solve each multiplication word problem. Use the given space to show your work.**

Four ninjas are practicing for the National Ninja Throwing Star Competition and all brought 6 throwing stars. How many throwing stars do they have in all?

**Answer:** \_\_\_\_\_

The famous group "Ninja Rangers" has five members. Each member has a small dagger and a long blade sword. How many weapons do they have in all?

**Answer:** \_\_\_\_\_

One ninja ordered four rolls of sushi. Each sushi roll is sliced into four parts. How many pieces of sushi did he get?

**Answer:** \_\_\_\_\_

**BONUS:** The emperor's palace is under attack! There are seven groups of ninjas protecting the perimeter, with nine ninjas per group. If every ninja catches three bad guys, how many bad guys were caught in all?"

**Answer:** \_\_\_\_\_

**WORD PROBLEMS**



# WORD PROBLEMS

**Solve each multiplication word problem. Use the given space to show your work.**

-----  
There are four horses and three ninjas standing in a stable. How many feet are there in total?

**Answer:** \_\_\_\_\_

-----  
There are six ninjas hiding in the trees inside of a forest. Each ninja has been hiding for three hours. How many hours did the ninjas hide in all?

**Answer:** \_\_\_\_\_

-----  
In a Ninjitsu class, a good student will get three stars for every ninja move they master. If there are 12 students in the class, and 9 of them has mastered a move today, how many stars were earned in all?

**Answer:** \_\_\_\_\_

**BONUS:** In the same Ninjitsu class, if a student receives one star for attending class that day, how many stars were earned including those given for attendance?

**Answer:** \_\_\_\_\_

# Lattice Multiplication

## 1 Digits x 2 Digits

1.

Write one number across the top of the grid, and the other number along the right side.

We are multiplying **7 x 62**

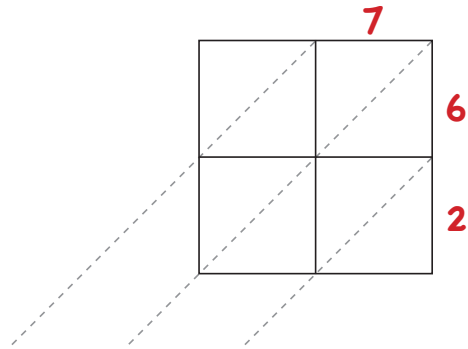

2.

Multiply each single digit on the top by each single digit on the right side.

Write answer in the square. Each triangle in the square gets its own digit. If the answer is a single digit, put 0 in the first triangle.

$$7 \times 6 = 42$$

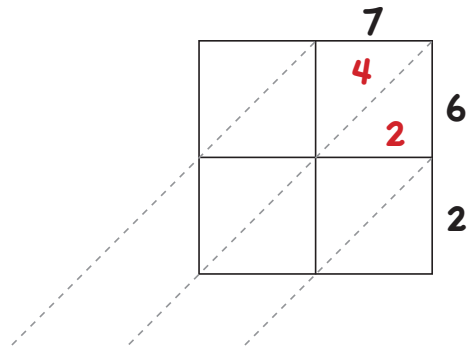

3.

Continue multiplying each single digit on the right side by the single digits on the top.

$$7 \times 2 = 14$$

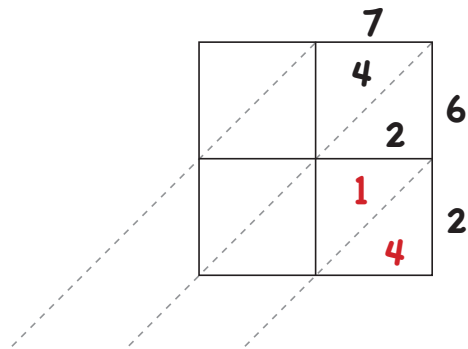

4.

Starting on the right, add numbers diagonally and write sum next to dotted line. You might have to carry two-digit sums to the next place.

**Sums from right to left:**

**4 (The bottom right triangle never changes.)**

$$2 + 1 = 3$$

$$4 + 0 = 4$$

**Answer:  $7 \times 62 = 434$**

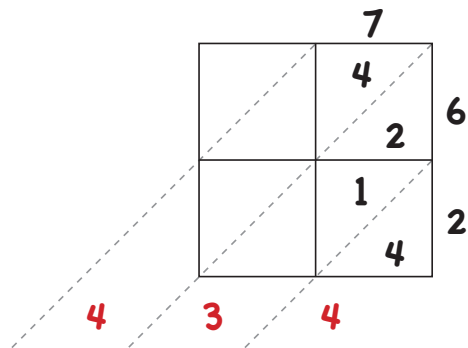

# Lattice Multiplication

## 2 Digits x 2 Digits

- 1.** Write one number across the top of the grid, and the other number along the right side.

We are multiplying **38 x 29**

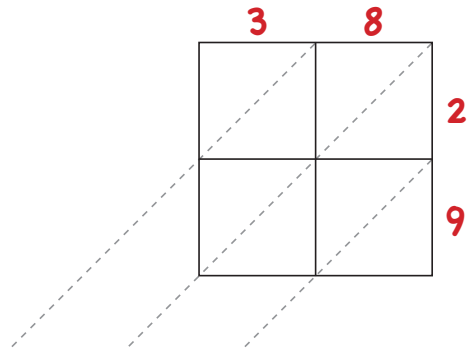

- 2.** Multiply each single digit on the top by each single digit on the right side.

Write answer in the square. Each triangle in the square gets its own digit. If the answer is a single digit, put 0 in the first triangle.

$$3 \times 2 = 6 \text{ (write 0, 6)}$$

$$8 \times 2 = 16$$

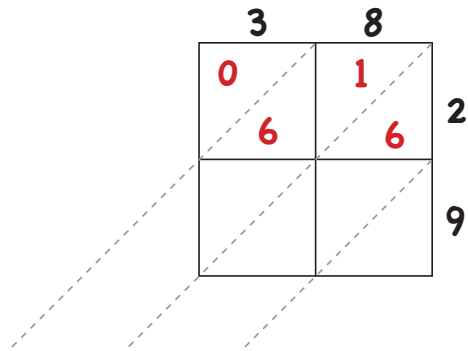

- 3.** Continue multiplying each single digit on the right side by the single digits on the top.

$$3 \times 9 = 27$$

$$8 \times 9 = 72$$

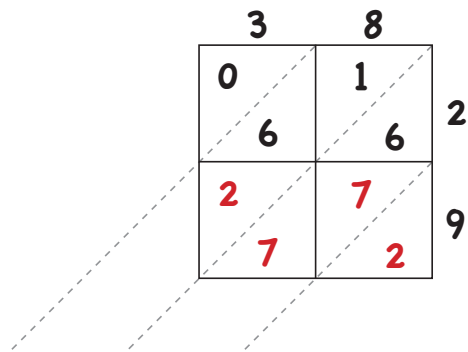

- 4.** Starting on the right, add numbers diagonally and write sum next to dotted line. You might have to carry two-digit sums to the next place.

**Sums from right to left:**

**2 (The bottom right triangle never changes.)**

$$6 + 7 + 7 = 20 \text{ (Write 0, carry the 2)}$$

$$1 + 6 + 2 \text{ (+ 2, the carried number)} = 11$$

**Answer: 38 x 29 = 1102**

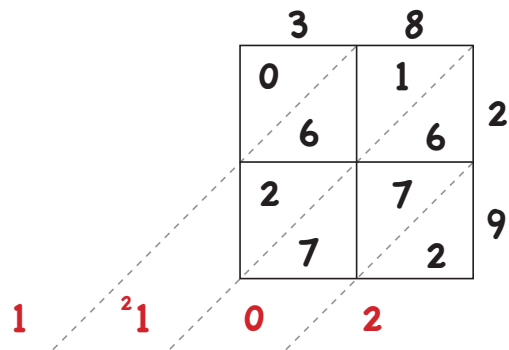

# MULTIPLICATION

1)  $34 \times 15$

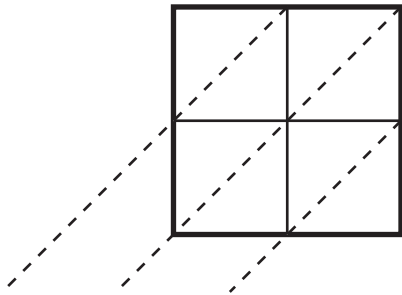

answer: \_\_\_\_\_

2)  $25 \times 17$

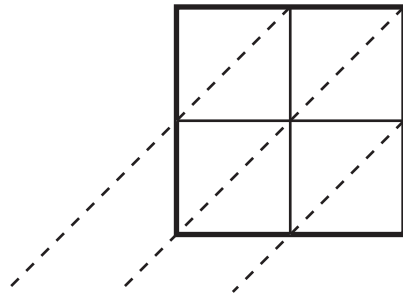

answer: \_\_\_\_\_

3)  $12 \times 13$

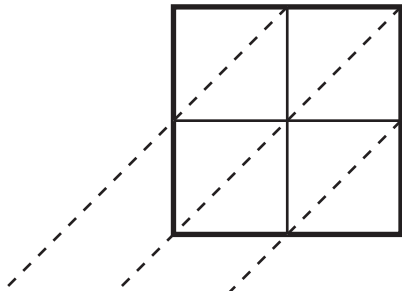

answer: \_\_\_\_\_

4)  $24 \times 11$

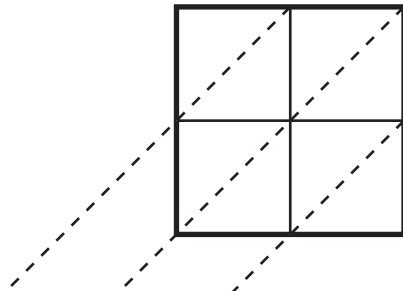

answer: \_\_\_\_\_

5)  $29 \times 40$

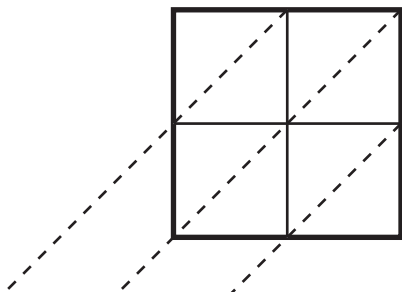

answer: \_\_\_\_\_

6)  $16 \times 23$

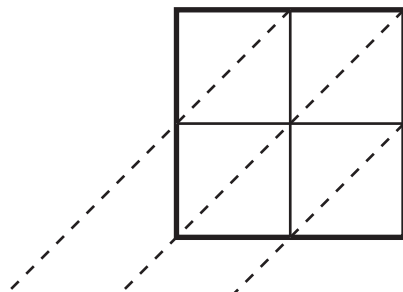

answer: \_\_\_\_\_

# MULTIPLICATION

1)  $30 \times 12$

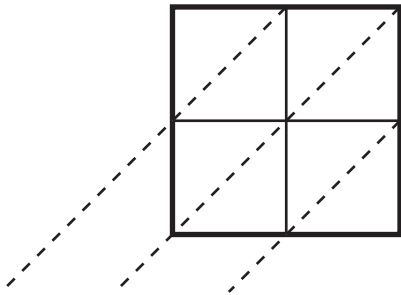

answer: \_\_\_\_\_

2)  $22 \times 33$

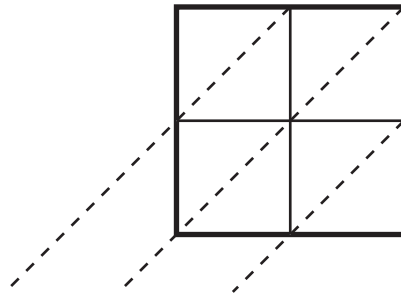

answer: \_\_\_\_\_

3)  $14 \times 28$

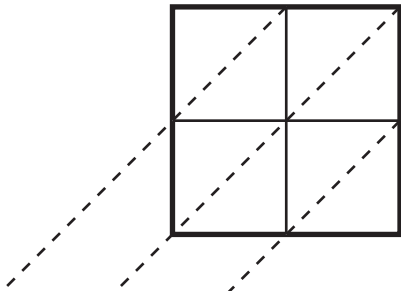

answer: \_\_\_\_\_

4)  $21 \times 23$

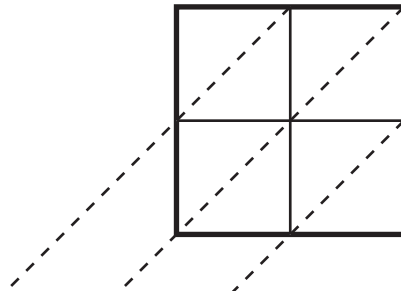

answer: \_\_\_\_\_

5)  $25 \times 25$

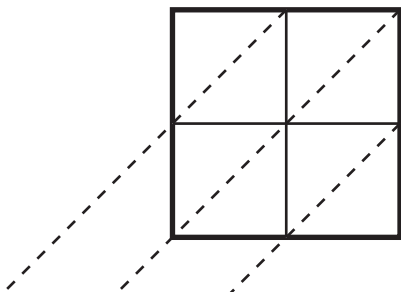

answer: \_\_\_\_\_

6)  $15 \times 18$

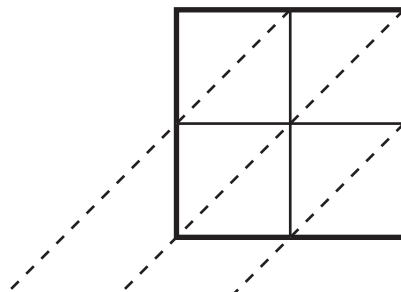

answer: \_\_\_\_\_

# MULTIPLICATION

1)  $33 \times 15$

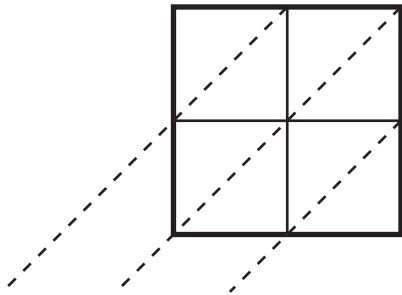

answer: \_\_\_\_\_

2)  $26 \times 19$

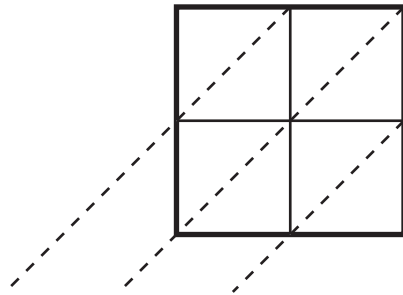

answer: \_\_\_\_\_

3)  $15 \times 17$

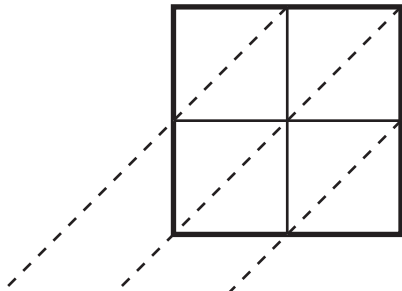

answer: \_\_\_\_\_

4)  $24 \times 13$

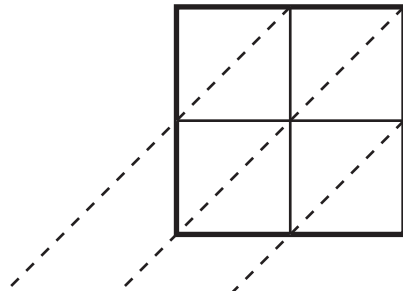

answer: \_\_\_\_\_

5)  $29 \times 21$

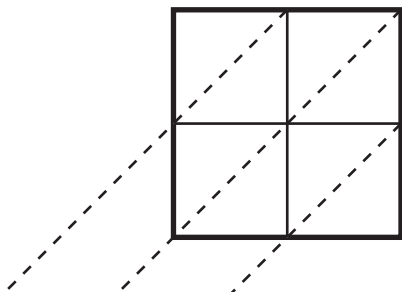

answer: \_\_\_\_\_

6)  $19 \times 32$

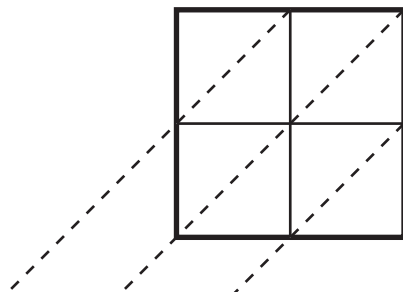

answer: \_\_\_\_\_



# 30 x 30 MULTIPLICATION TABLE

1	2	3	4	5	6	7	8	9	10	11	12	13	14	15	16	17	18	19	20	21	22	23	24	25	26	27	28	29	30
2	4	6	8	10	12	14	16	18	20	22	24	26	28	30	32	34	36	38	40	42	44	46	48	50	52	54	56	58	60
3	6	9	12	15	18	21	24	27	30	33	36	39	42	45	48	51	54	57	60	63	66	69	72	75	78	81	84	87	90
4	8	12	16	20	24	28	32	36	40	44	48	52	56	60	64	68	72	76	80	84	88	92	96	100	104	108	112	116	120
5	10	15	20	25	30	35	40	45	50	55	60	65	70	75	80	85	90	95	100	105	110	115	120	125	130	135	140	145	150
6	12	18	24	30	36	42	48	54	60	66	72	78	84	90	96	102	108	114	120	126	132	138	144	150	156	162	168	174	180
7	14	21	28	35	42	49	56	63	70	77	84	91	98	105	112	119	126	133	140	147	154	161	168	175	182	189	196	203	210
8	16	24	32	40	48	56	64	72	80	88	96	104	112	120	128	136	144	152	160	168	176	184	192	200	208	216	224	232	240
9	18	27	36	45	54	63	72	81	90	99	108	117	126	135	144	153	162	171	180	189	198	207	216	225	234	243	252	261	270
10	20	30	40	50	60	70	80	90	100	110	120	130	140	150	160	170	180	190	200	210	220	230	240	250	260	270	280	290	300
11	22	33	44	55	66	77	88	99	110	121	132	143	154	165	176	187	198	209	220	231	242	253	264	275	286	297	308	319	330
12	24	36	48	60	72	84	96	108	120	132	144	156	168	180	192	204	216	228	240	252	264	276	288	300	312	324	336	348	360
13	26	39	52	65	78	91	104	117	139	143	156	169	182	195	208	221	234	247	260	273	286	299	312	325	338	351	364	377	390
14	28	42	56	70	84	98	112	126	140	154	168	182	196	210	224	238	252	266	280	294	308	322	336	350	364	378	392	406	420
15	30	45	60	75	90	105	120	135	150	165	180	195	210	225	240	255	270	285	300	315	330	345	360	375	390	405	420	435	450
16	32	48	64	80	96	112	128	144	160	176	192	208	224	240	256	272	288	304	320	336	352	368	384	400	416	432	448	464	480
17	34	51	68	85	102	119	136	153	170	187	204	221	238	255	272	289	306	323	340	357	374	391	408	425	442	459	476	493	510
18	36	54	72	90	108	126	144	162	180	198	216	234	252	270	288	306	324	342	360	378	396	414	432	450	468	486	504	522	540
19	38	57	76	95	114	133	152	171	190	209	228	247	266	285	304	323	342	361	380	399	418	437	456	475	494	513	532	551	570
20	40	60	80	100	120	140	160	180	200	220	240	260	280	300	320	340	360	380	400	420	440	460	480	500	520	540	560	580	600
21	42	63	84	105	126	147	168	189	210	231	252	273	294	315	336	357	378	399	420	441	462	483	504	525	546	567	588	609	630
22	44	66	88	110	132	154	176	198	220	242	264	286	308	330	352	374	396	418	440	462	484	506	528	550	572	594	616	638	660
23	46	69	92	115	138	161	184	207	230	253	276	299	322	345	368	391	414	437	460	483	506	529	552	575	598	621	644	667	690
24	48	72	96	120	144	168	192	216	240	264	288	312	336	360	384	408	432	456	480	504	528	552	576	600	624	648	672	696	720
25	50	75	100	125	150	175	200	225	250	275	300	325	350	375	400	425	450	475	500	525	550	575	600	625	650	675	700	725	750
26	52	78	104	130	156	182	208	234	260	286	312	338	364	390	416	442	468	494	520	546	572	598	624	650	676	702	728	754	780
27	54	81	108	135	162	189	216	243	270	297	324	351	378	405	432	459	486	513	540	567	594	621	648	675	702	729	756	783	810
28	56	84	112	140	168	196	224	252	280	308	336	364	392	420	448	476	504	534	560	588	616	644	672	700	728	756	784	812	840
29	58	87	116	145	174	203	232	261	290	319	348	377	406	435	464	493	522	551	580	609	638	667	696	725	754	783	812	841	870
30	60	90	120	150	180	210	240	270	300	330	360	390	420	450	480	510	540	570	600	630	660	690	720	750	780	810	840	870	900

Great job!

---

is an Education.com math superstar

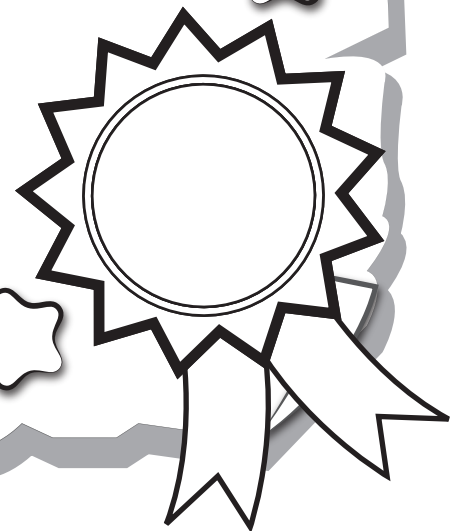

# Answer Sheets

---

## **Ninja Multiplication**

Ninja Multiplication: Multiplying by 7

Ninja Multiplication: Multiplying by 8

Ninja Multiplication: Multiplying by 9

2-Digit Multiplication #1

2-Digit Multiplication #2

Ninja Word Hunt #1

Ninja Word Hunt #2

Ninja Word Problems #1

Ninja Word Problems #2

Lattice Multiplication #1

Lattice Multiplication #2

Lattice Multiplication #3

Want more workbooks? Join Education.com Plus to save time and money.  
<http://www.education.com/education-plus/>

# Answer Sheet



## NINJA MULTIPLICATION

### \* MULTIPLYING BY 7 \*

Master your multiplication skills by completing each equation.



$$\begin{array}{r} 2 \\ \times 7 \\ \hline 14 \end{array}$$

$$\begin{array}{r} 10 \\ \times 7 \\ \hline 70 \end{array}$$

$$\begin{array}{r} 3 \\ \times 7 \\ \hline 21 \end{array}$$

$$\begin{array}{r} 15 \\ \times 7 \\ \hline 105 \end{array}$$

$$\begin{array}{r} 6 \\ \times 7 \\ \hline 42 \end{array}$$

$$\begin{array}{r} 7 \\ \times 7 \\ \hline 49 \end{array}$$

$$\begin{array}{r} 4 \\ \times 7 \\ \hline 28 \end{array}$$

$$\begin{array}{r} 11 \\ \times 7 \\ \hline 77 \end{array}$$

$$\begin{array}{r} 8 \\ \times 7 \\ \hline 56 \end{array}$$

$$\begin{array}{r} 13 \\ \times 7 \\ \hline 91 \end{array}$$

$$\begin{array}{r} 1 \\ \times 7 \\ \hline 7 \end{array}$$

$$\begin{array}{r} 20 \\ \times 7 \\ \hline 140 \end{array}$$

$$\begin{array}{r} 12 \\ \times 7 \\ \hline 84 \end{array}$$

$$\begin{array}{r} 18 \\ \times 7 \\ \hline 126 \end{array}$$

$$\begin{array}{r} 9 \\ \times 7 \\ \hline 63 \end{array}$$

$$\begin{array}{r} 14 \\ \times 7 \\ \hline 98 \end{array}$$

$$\begin{array}{r} 22 \\ \times 7 \\ \hline 154 \end{array}$$

$$\begin{array}{r} 16 \\ \times 7 \\ \hline 112 \end{array}$$

$$\begin{array}{r} 5 \\ \times 7 \\ \hline 35 \end{array}$$

$$\begin{array}{r} 17 \\ \times 7 \\ \hline 119 \end{array}$$

# Answer Sheet



## NINJA MULTIPLICATION

### \* MULTIPLYING BY 8 \*

Master your multiplication skills by completing each equation.



$$\begin{array}{r} 3 \\ \times 8 \\ \hline 24 \end{array}$$

$$\begin{array}{r} 14 \\ \times 8 \\ \hline 112 \end{array}$$

$$\begin{array}{r} 9 \\ \times 8 \\ \hline 72 \end{array}$$

$$\begin{array}{r} 20 \\ \times 8 \\ \hline 160 \end{array}$$

$$\begin{array}{r} 2 \\ \times 8 \\ \hline 16 \end{array}$$

$$\begin{array}{r} 10 \\ \times 8 \\ \hline 80 \end{array}$$

$$\begin{array}{r} 13 \\ \times 8 \\ \hline 104 \end{array}$$

$$\begin{array}{r} 7 \\ \times 8 \\ \hline 56 \end{array}$$

$$\begin{array}{r} 8 \\ \times 8 \\ \hline 64 \end{array}$$

$$\begin{array}{r} 6 \\ \times 8 \\ \hline 48 \end{array}$$

$$\begin{array}{r} 12 \\ \times 8 \\ \hline 96 \end{array}$$

$$\begin{array}{r} 16 \\ \times 8 \\ \hline 128 \end{array}$$

$$\begin{array}{r} 21 \\ \times 8 \\ \hline 168 \end{array}$$

$$\begin{array}{r} 1 \\ \times 8 \\ \hline 8 \end{array}$$

$$\begin{array}{r} 5 \\ \times 8 \\ \hline 40 \end{array}$$

$$\begin{array}{r} 4 \\ \times 8 \\ \hline 32 \end{array}$$

$$\begin{array}{r} 19 \\ \times 8 \\ \hline 152 \end{array}$$

$$\begin{array}{r} 11 \\ \times 8 \\ \hline 88 \end{array}$$

$$\begin{array}{r} 15 \\ \times 8 \\ \hline 120 \end{array}$$

$$\begin{array}{r} 17 \\ \times 8 \\ \hline 136 \end{array}$$

# Answer Sheet



## NINJA MULTIPLICATION

### \* MULTIPLYING BY 9 \*

Master your multiplication skills by completing each equation.



$$\begin{array}{r} 5 \\ \times 9 \\ \hline 45 \end{array}$$

$$\begin{array}{r} 12 \\ \times 9 \\ \hline 108 \end{array}$$

$$\begin{array}{r} 3 \\ \times 9 \\ \hline 27 \end{array}$$

$$\begin{array}{r} 20 \\ \times 9 \\ \hline 180 \end{array}$$

$$\begin{array}{r} 4 \\ \times 9 \\ \hline 36 \end{array}$$

$$\begin{array}{r} 10 \\ \times 9 \\ \hline 90 \end{array}$$

$$\begin{array}{r} 13 \\ \times 9 \\ \hline 117 \end{array}$$

$$\begin{array}{r} 7 \\ \times 9 \\ \hline 63 \end{array}$$

$$\begin{array}{r} 14 \\ \times 9 \\ \hline 126 \end{array}$$

$$\begin{array}{r} 1 \\ \times 9 \\ \hline 9 \end{array}$$

$$\begin{array}{r} 19 \\ \times 9 \\ \hline 171 \end{array}$$

$$\begin{array}{r} 0 \\ \times 9 \\ \hline 0 \end{array}$$

$$\begin{array}{r} 9 \\ \times 9 \\ \hline 81 \end{array}$$

$$\begin{array}{r} 11 \\ \times 9 \\ \hline 99 \end{array}$$

$$\begin{array}{r} 6 \\ \times 9 \\ \hline 54 \end{array}$$

$$\begin{array}{r} 8 \\ \times 9 \\ \hline 72 \end{array}$$

$$\begin{array}{r} 16 \\ \times 9 \\ \hline 144 \end{array}$$

$$\begin{array}{r} 2 \\ \times 9 \\ \hline 18 \end{array}$$

$$\begin{array}{r} 18 \\ \times 9 \\ \hline 162 \end{array}$$

$$\begin{array}{r} 15 \\ \times 9 \\ \hline 135 \end{array}$$

# Answer Sheet

## 2-DIGIT MULTIPLICATION



$$\begin{array}{r} 27 \\ \times 3 \\ \hline 81 \end{array}$$

$$\begin{array}{r} 65 \\ \times 9 \\ \hline 585 \end{array}$$



MULTIPLY. REGROUP IF NEEDED.

$$\begin{array}{r} 6 \\ 77 \\ \times 9 \\ \hline 693 \end{array}$$

$$\begin{array}{r} 19 \\ \times 6 \\ \hline 114 \end{array}$$

$$\begin{array}{r} 24 \\ \times 8 \\ \hline 192 \end{array}$$

$$\begin{array}{r} 90 \\ \times 7 \\ \hline 630 \end{array}$$

$$\begin{array}{r} 36 \\ \times 5 \\ \hline 180 \end{array}$$

$$\begin{array}{r} 21 \\ \times 6 \\ \hline 126 \end{array}$$

$$\begin{array}{r} 82 \\ \times 4 \\ \hline 328 \end{array}$$

$$\begin{array}{r} 78 \\ \times 9 \\ \hline 702 \end{array}$$

$$\begin{array}{r} 63 \\ \times 9 \\ \hline 567 \end{array}$$

$$\begin{array}{r} 58 \\ \times 2 \\ \hline 116 \end{array}$$

$$\begin{array}{r} 61 \\ \times 4 \\ \hline 244 \end{array}$$

$$\begin{array}{r} 38 \\ \times 9 \\ \hline 342 \end{array}$$

$$\begin{array}{r} 13 \\ \times 7 \\ \hline 91 \end{array}$$

$$\begin{array}{r} 52 \\ \times 5 \\ \hline 260 \end{array}$$

$$\begin{array}{r} 99 \\ \times 5 \\ \hline 495 \end{array}$$

$$\begin{array}{r} 46 \\ \times 7 \\ \hline 322 \end{array}$$

$$\begin{array}{r} 29 \\ \times 8 \\ \hline 232 \end{array}$$

$$\begin{array}{r} 98 \\ \times 3 \\ \hline 294 \end{array}$$

$$\begin{array}{r} 23 \\ \times 7 \\ \hline 161 \end{array}$$

$$\begin{array}{r} 72 \\ \times 3 \\ \hline 216 \end{array}$$

$$\begin{array}{r} 25 \\ \times 6 \\ \hline 150 \end{array}$$

$$\begin{array}{r} 68 \\ \times 8 \\ \hline 544 \end{array}$$

$$\begin{array}{r} 43 \\ \times 8 \\ \hline 344 \end{array}$$

$$\begin{array}{r} 52 \\ \times 3 \\ \hline 156 \end{array}$$

$$\begin{array}{r} 75 \\ \times 9 \\ \hline 675 \end{array}$$



# Answer Sheet

## 2-DIGIT MULTIPLICATION



$$\begin{array}{r} 85 \\ \times 13 \\ \hline 255 \\ + 850 \\ \hline \end{array}$$

**1105**

$$\begin{array}{r} 95 \\ \times 38 \\ \hline 760 \\ + 2850 \\ \hline \end{array}$$

**3610**



MULTIPLY. REGROUP IF NEEDED.

$$\begin{array}{r} \phantom{0}^2 97 \\ \times 30 \\ \hline 00 \\ + 2910 \\ \hline 2910 \end{array}$$

$$\begin{array}{r} 58 \\ \times 46 \\ \hline 2668 \end{array}$$

$$\begin{array}{r} 85 \\ \times 34 \\ \hline 2890 \end{array}$$

$$\begin{array}{r} 72 \\ \times 47 \\ \hline 3384 \end{array}$$

$$\begin{array}{r} 97 \\ \times 18 \\ \hline 1746 \end{array}$$

$$\begin{array}{r} 46 \\ \times 21 \\ \hline 2910 \end{array}$$

$$\begin{array}{r} 92 \\ \times 38 \\ \hline 3496 \end{array}$$

$$\begin{array}{r} 44 \\ \times 12 \\ \hline 528 \end{array}$$

$$\begin{array}{r} 83 \\ \times 49 \\ \hline 4067 \end{array}$$

$$\begin{array}{r} 62 \\ \times 29 \\ \hline 1798 \end{array}$$

$$\begin{array}{r} 81 \\ \times 51 \\ \hline 4131 \end{array}$$

$$\begin{array}{r} 47 \\ \times 29 \\ \hline 1363 \end{array}$$

$$\begin{array}{r} 65 \\ \times 23 \\ \hline 1495 \end{array}$$

$$\begin{array}{r} 58 \\ \times 25 \\ \hline 1450 \end{array}$$

$$\begin{array}{r} 47 \\ \times 32 \\ \hline 1504 \end{array}$$



# Answer Sheet

## NINJA WORD HUNT

Learn the ways of the ninja! Uncover the mysteries of the ninja by encoding the answer to the question below. Solve the following multiplication equations then match each answer to its own letter.

**\* What does "Ninjitsu" mean? \***

<b>A</b>	<b>B</b>	<b>C</b>	<b>D</b>	<b>E</b>	<b>F</b>	<b>G</b>	<b>H</b>	<b>I</b>	<b>J</b>	<b>K</b>	<b>L</b>	<b>M</b>
1	2	3	4	5	6	7	8	9	10	11	12	13
<b>N</b>	<b>O</b>	<b>P</b>	<b>Q</b>	<b>R</b>	<b>S</b>	<b>T</b>	<b>U</b>	<b>V</b>	<b>W</b>	<b>X</b>	<b>Y</b>	<b>Z</b>
14	15	16	17	18	19	20	21	22	23	24	25	26

Example:  $19 \times 164 = \frac{3}{1} \mid \frac{1}{2} \mid \frac{1}{3} \frac{8}{3} \rightarrow \frac{C}{1} \frac{A}{2} \frac{P}{3}$

$$2 \times 59 = \frac{1}{1} \mid \frac{1}{2} \frac{8}{2}$$

$$2 \times 5 \times 2 = \frac{2}{3} \frac{0}{3}$$

$$12 \times 13 = \frac{1}{4} \frac{5}{4} \mid \frac{6}{5}$$

$$30 \times 64 = \frac{1}{6} \frac{9}{6} \mid \frac{2}{7} \frac{0}{7}$$

$$213 \times 24 = \frac{5}{8} \mid \frac{1}{9} \mid \frac{1}{10} \frac{2}{10}$$

$$26 \times 8 = \frac{2}{11} \frac{0}{11} \mid \frac{8}{12}$$

"Ninjitsu" means:

$\frac{A}{1} \frac{R}{2} \frac{T}{3} \quad \frac{O}{4} \frac{F}{5} \quad \frac{S}{6} \frac{T}{7} \frac{E}{8} \frac{A}{9} \frac{L}{10} \frac{T}{11} \frac{H}{12}$

# Answer Sheet

## NINJA WORD HUNT

Learn the ways of the ninja! Uncover the mysteries of the ninja by encoding the answer to the question below. Solve the following multiplication equations then match each answer to its own letter.

**What's the most common ninja weapon?**

<b>A</b>	<b>B</b>	<b>C</b>	<b>D</b>	<b>E</b>	<b>F</b>	<b>G</b>	<b>H</b>	<b>I</b>	<b>J</b>	<b>K</b>	<b>L</b>	<b>M</b>
1	2	3	4	5	6	7	8	9	10	11	12	13
<b>N</b>	<b>O</b>	<b>P</b>	<b>Q</b>	<b>R</b>	<b>S</b>	<b>T</b>	<b>U</b>	<b>V</b>	<b>W</b>	<b>X</b>	<b>Y</b>	<b>Z</b>
14	15	16	17	18	19	20	21	22	23	24	25	26

Example:  $19 \times 164 = \frac{3}{1} \frac{1}{2} \frac{1}{3} \frac{8}{3} \rightarrow \frac{C}{1} \frac{A}{2} \frac{P}{3}$

$$52 \times 4 = \frac{2}{1} \frac{0}{2} \frac{8}{2}$$

$$121 \times 15 = \frac{1}{3} \frac{8}{4} \frac{1}{4} \frac{5}{4}$$

$$23 \times 1 = \frac{2}{5} \frac{3}{5}$$

$$457 \times 2 = \frac{9}{6} \frac{1}{7} \frac{4}{7}$$

$$353 \times 2 + 13 = \frac{7}{8} \frac{1}{9} \frac{9}{9}$$

$$67 \times 3 = \frac{2}{10} \frac{0}{11} \frac{1}{11}$$

$$450 \times 4 + 19 = \frac{1}{12} \frac{8}{13} \frac{1}{13} \frac{9}{13}$$

**Ninjas always carry:**

T H R O W I N G      S T A R S  
 1    2    3    4    5    6    7    8            9    10   11   12   13

# Answer Sheet



WORD  
PROBLEMS

Solve each multiplication word problem. Use the given space to show your work.

Four ninjas are practicing for the National Ninja Throwing Star Competition and all brought 6 throwing stars. How many throwing stars do they have in all?

$$4 \times 6 = 24$$

Answer: 24

The famous group "Ninja Rangers" has five members. Each member has a small dagger and a long blade sword. How many weapons do they have in all?

$$5 \times 2 = 10$$

Answer: 10

One ninja ordered four rolls of sushi. Each sushi roll is sliced into four parts. How many pieces of sushi did he get?

$$4 \times 4 = 16$$

Answer: 16

**BONUS:** The emperor's palace is under attack! There are seven groups of ninjas protecting the perimeter, with nine ninjas per group. If every ninja catches three bad guys, how many bad guys were caught in all?"

$$7 \times 9 \times 3 = 189$$

Answer: 189

# Answer Sheet



WORD  
PROBLEMS

Solve each multiplication word problem. Use the given space to show your work.

There are four horses and three ninjas standing in a stable. How many feet are there in total?

$$4 \times 4 = 16$$

horse feet

$$3 \times 2 = 6$$

ninja feet

$$16 + 6 = 22$$

total feet

Answer: 22

There are six ninjas hiding in the trees inside of a forest. Each ninja has been hiding for three hours. How many hours did the ninjas hide in all?

$$6 \times 3 = 18$$

Answer: 18

In a Ninjitsu class, a good student will get three stars for every ninja move they master. If there are 12 students in the class, and 9 of them has mastered a move today, how many stars were earned in all?

$$9 \times 3 = 27$$

Answer: 27

**BONUS:** In the same Ninjitsu class, if a student receives one star for attending class that day, how many stars were earned including those given for attendance?

$$27 + 12 = 39$$

Answer: 39

# Answer Sheet

## M U L T I P L I C A T I O N

1)  $34 \times 15$

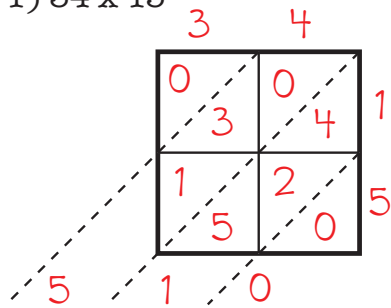

answer: 510

2)  $25 \times 17$

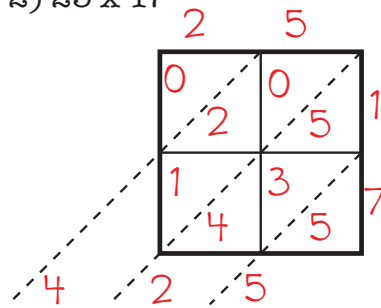

answer: 425

3)  $12 \times 13$

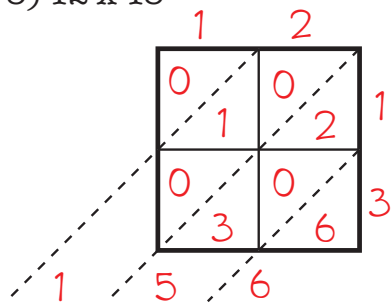

answer: 156

4)  $24 \times 11$

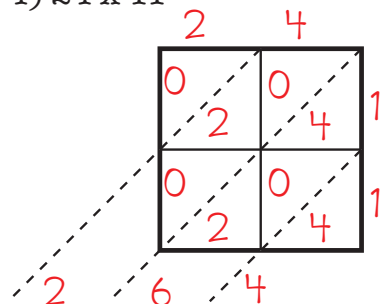

answer: 264

5)  $29 \times 40$

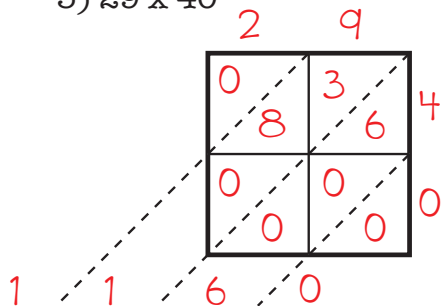

answer: 1160

6)  $16 \times 23$

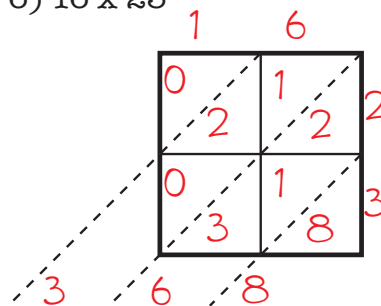

answer: 368

# Answer Sheet

## M U L T I P L I C A T I O N

1)  $30 \times 12$

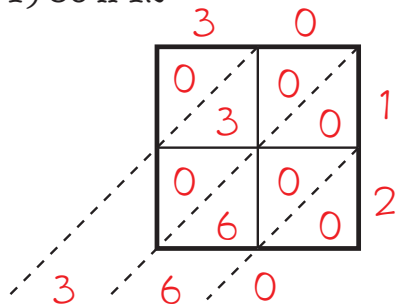

answer: 360

2)  $22 \times 33$

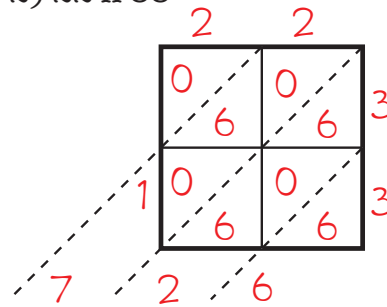

answer: 726

3)  $14 \times 28$

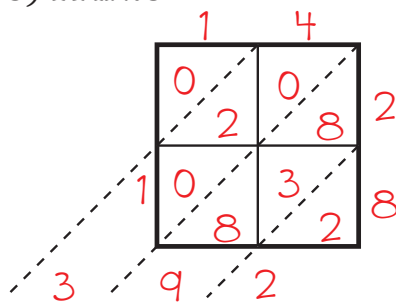

answer: 392

4)  $21 \times 23$

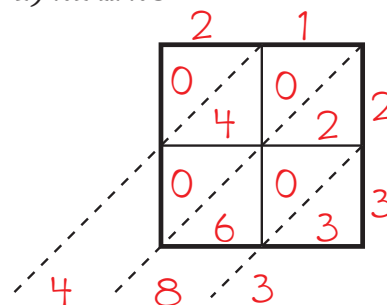

answer: 483

5)  $25 \times 25$

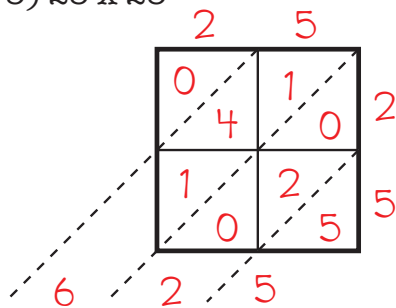

answer: 625

6)  $15 \times 18$

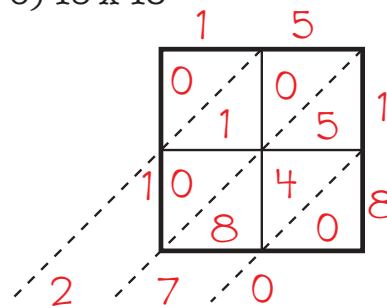

answer: 270

# Answer Sheet

## MULTIPLICATION TABLE

1)  $33 \times 15$

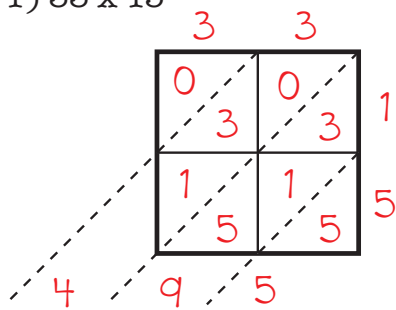

answer: 495

2)  $26 \times 19$

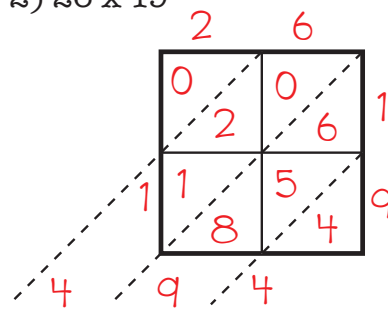

answer: 494

3)  $15 \times 17$

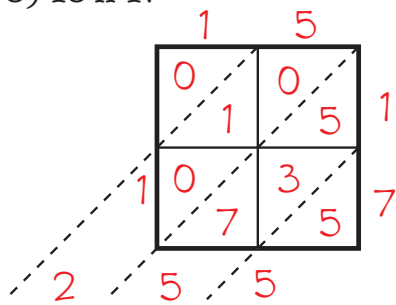

answer: 255

4)  $24 \times 13$

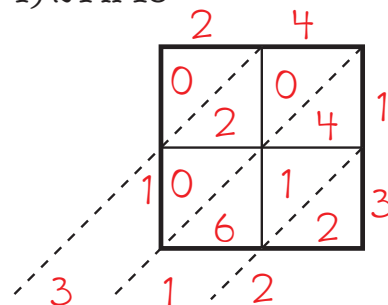

answer: 312

5.)  $29 \times 21$

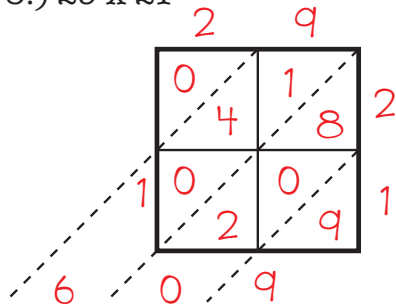

answer: 609

6)  $19 \times 32$

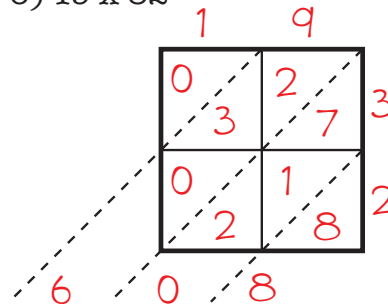

answer: 608