

Craftsman Lectern

Directional Views of Table

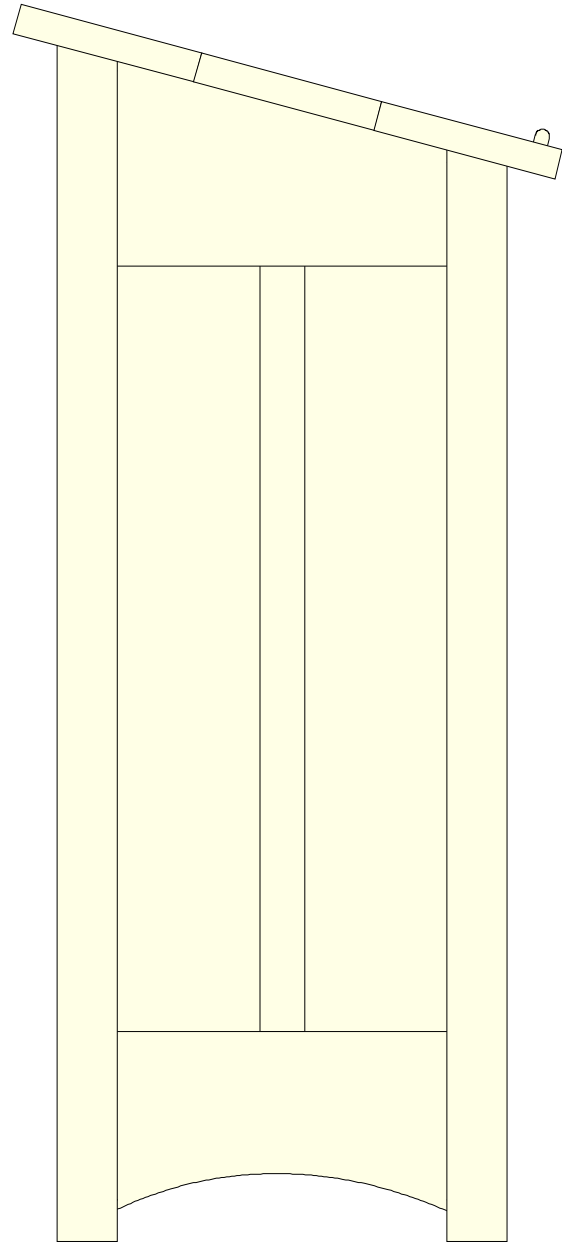

Side View

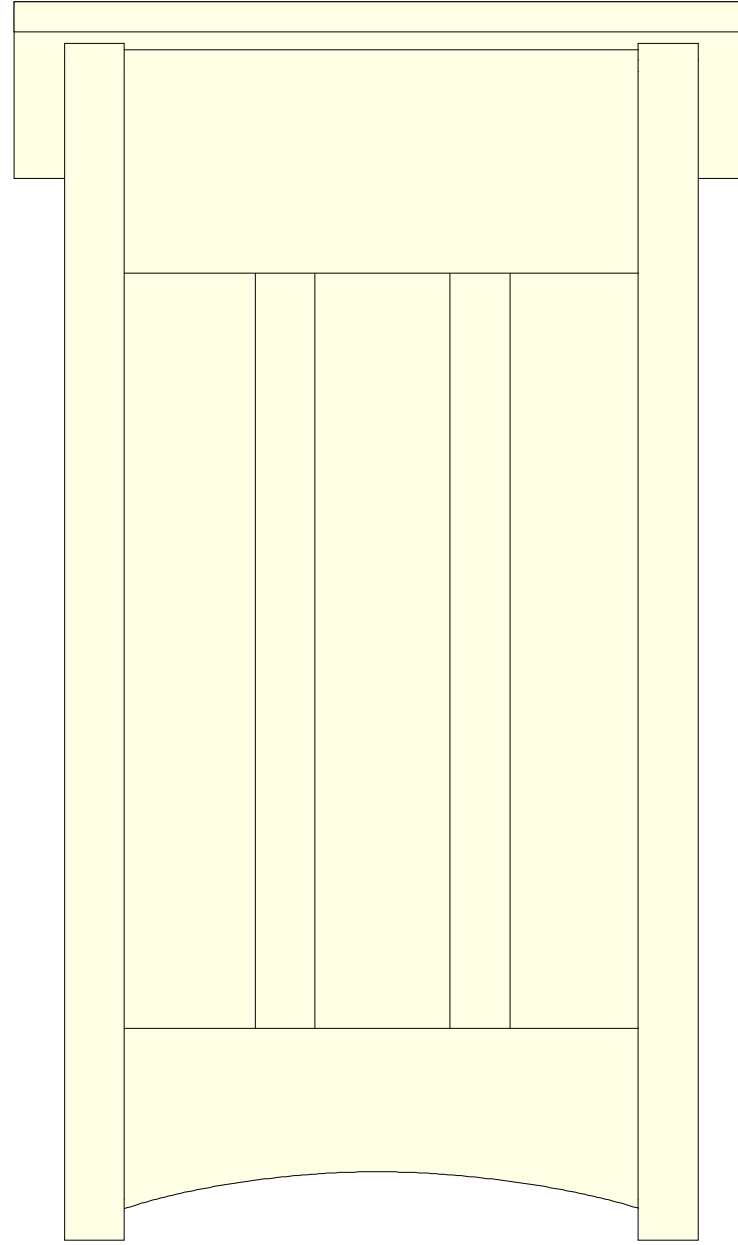

Front View

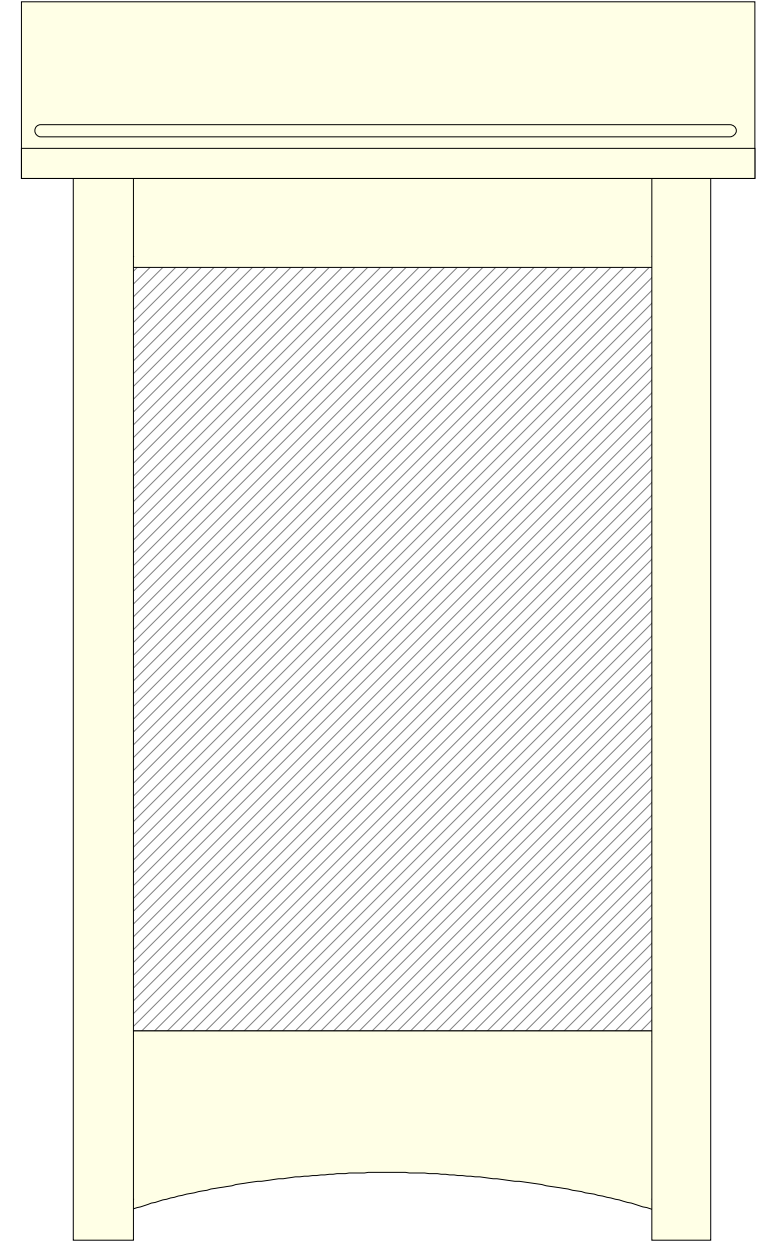

Rear View

Exploded Side View of Lectern

- | | |
|--------------------|----------------------|
| A) Front Leg | F) Muntin |
| B) Rear Leg | G) Bottom Shelf |
| C) Upper Side Rail | H) Top Plank |
| D) Lower Side Rail | I) Grooved Top Plank |
| E) Panel | J) Ledge |

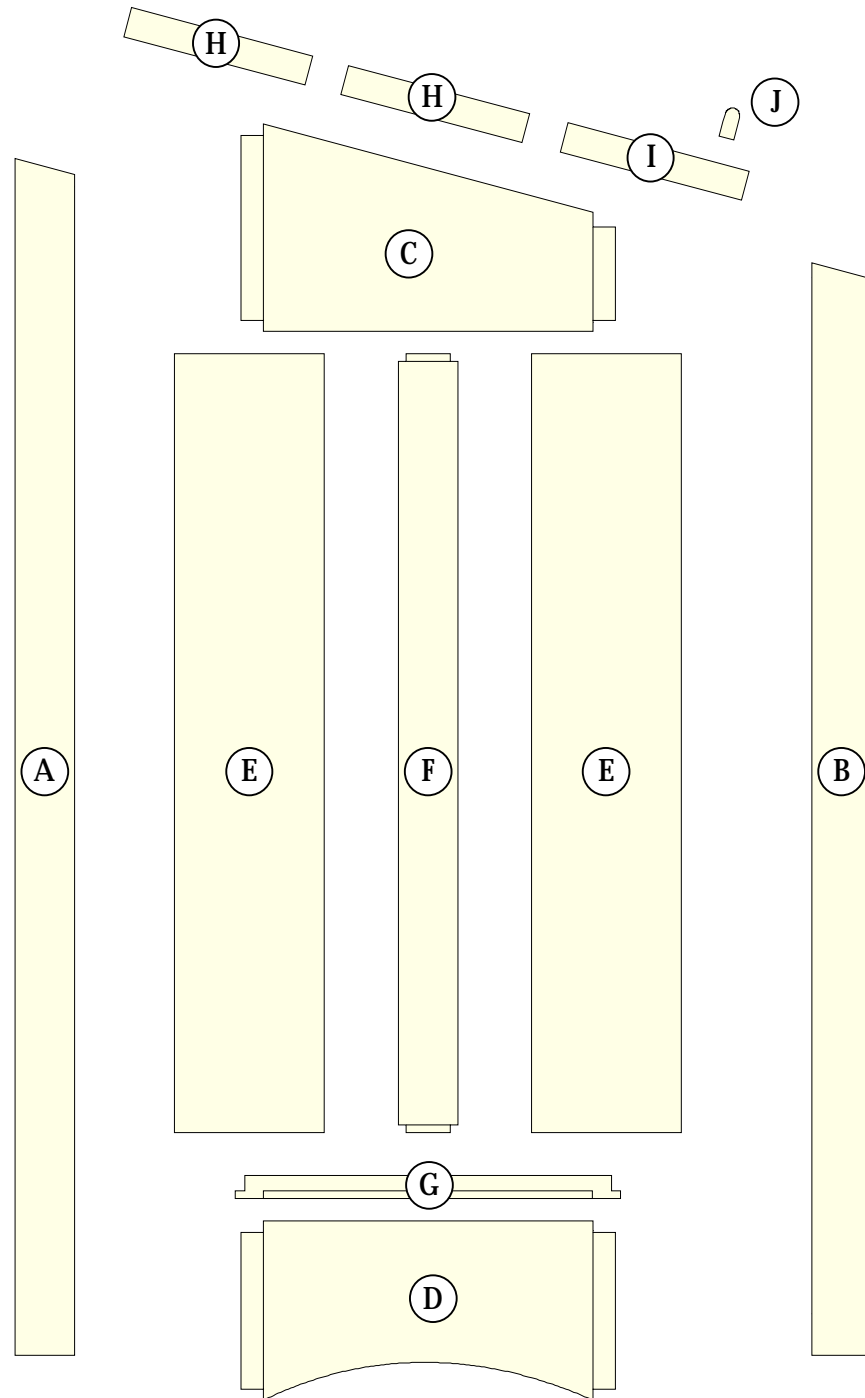

Exploded Front View of Lectern

- | | |
|---------------------|-----------------|
| A) Front Leg | D) Panel |
| B) Upper Front Rail | E) Muntin |
| C) Lower Front Rail | F) Bottom Shelf |

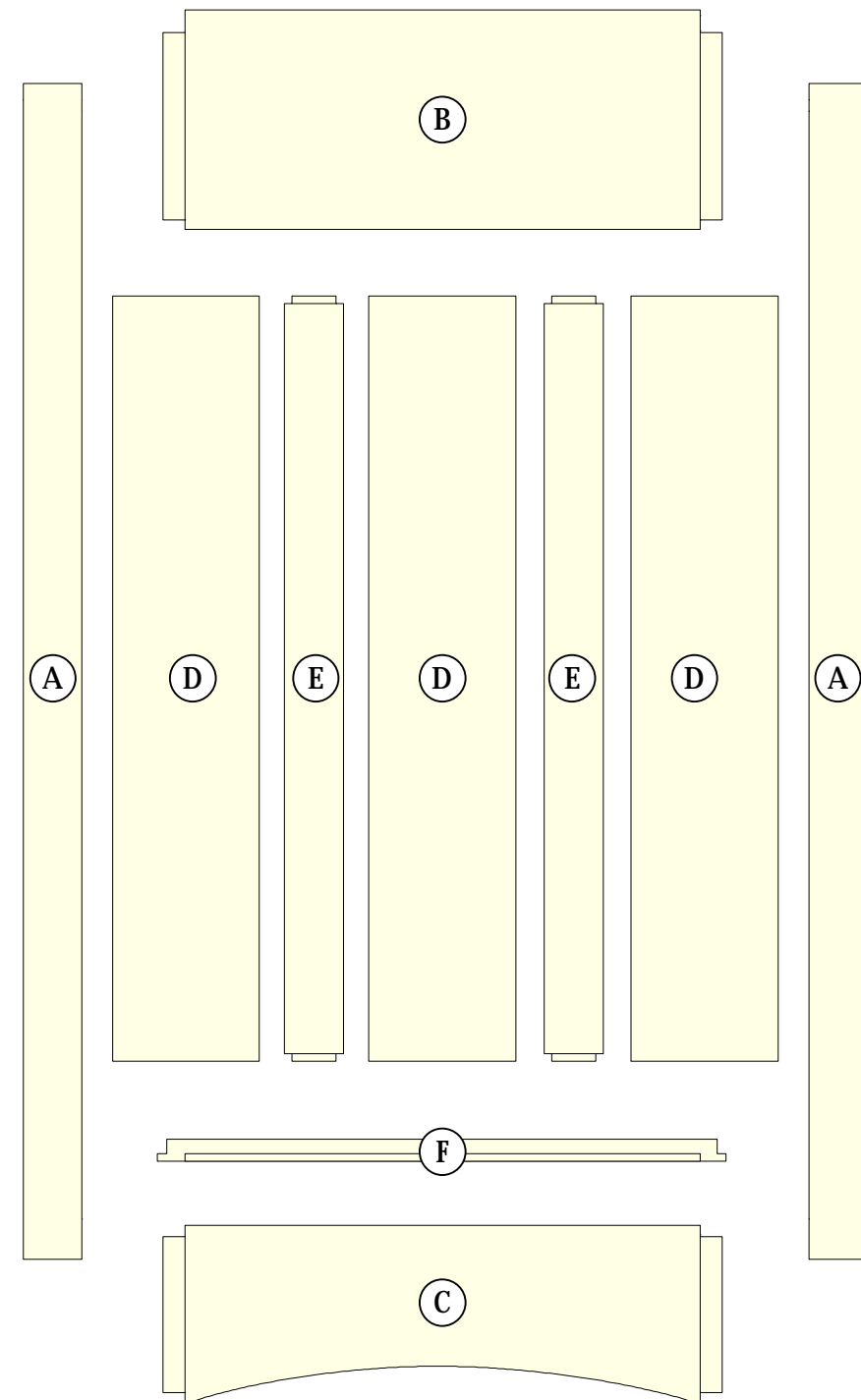

Exploded Rear View of Lectern

- A) Rear Leg
- B) Upper Front Rail
- C) Lower Front Rail
- D) Bottom Panel

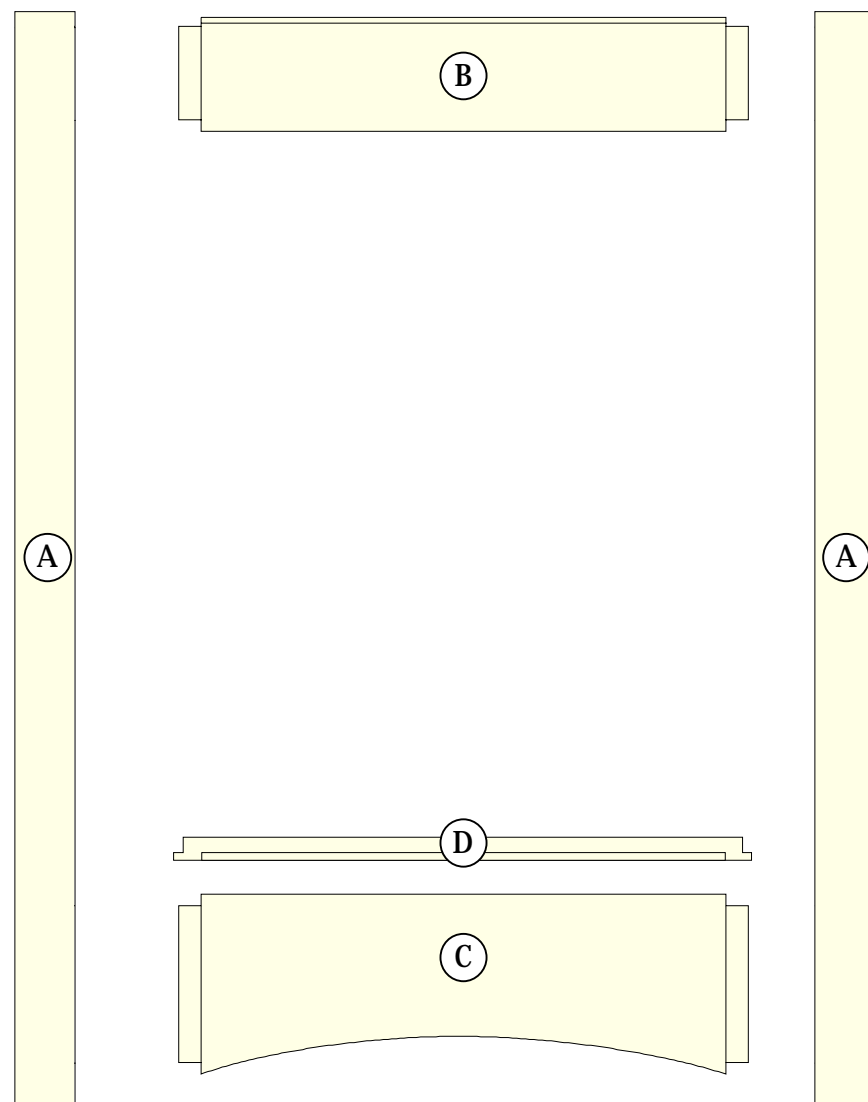

Exploded View of Lectern Table

- A) Top Plank
- B) Grooved Top Plank
- C) Ledge

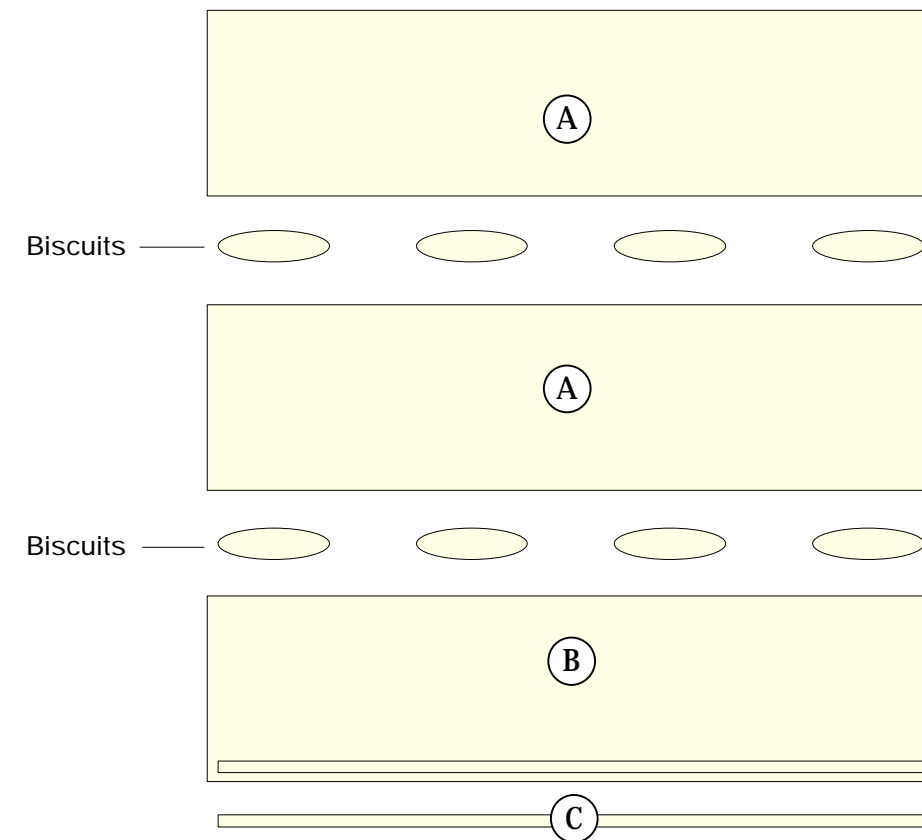

Right Front Leg

Rear View

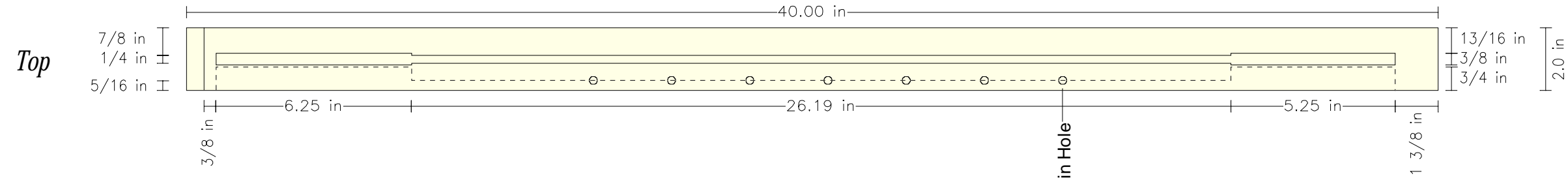

Side View

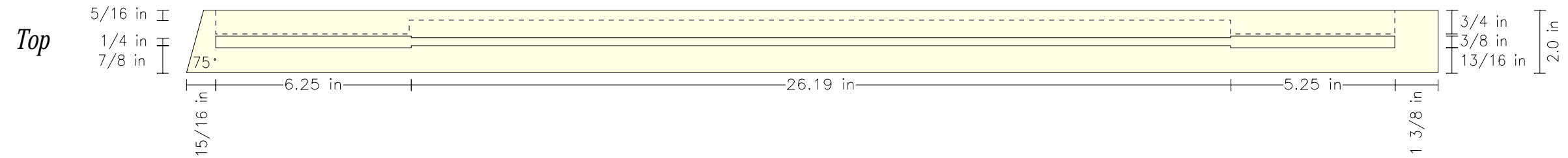

Note A : Left and right is given as seen when standing behind the lectern.

Note B : Shelf pin holes are optional and are only shown to illustrate their general position. The actual location of the holes (if installed) will depend on the diameter and length of the pins and the number of possible shelf positions that the builder wants to facilitate.

Left Front Leg

Rear View

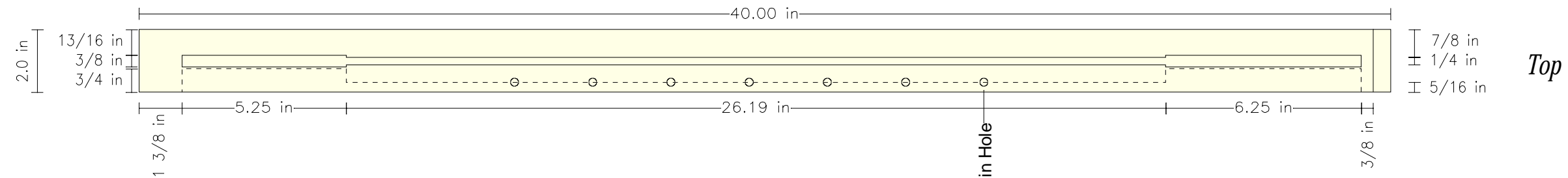

Side View

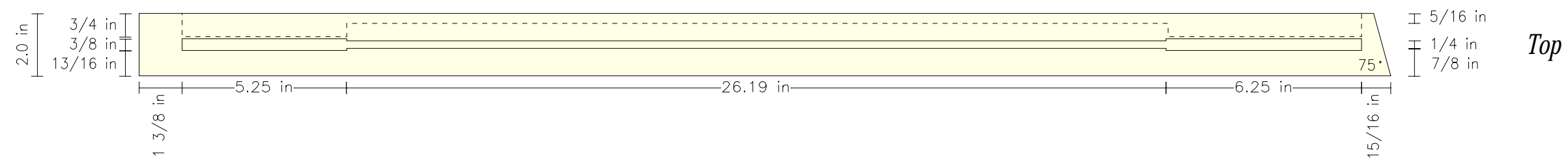

Right Rear Leg

Front View

Shelf Pin Hole

Top

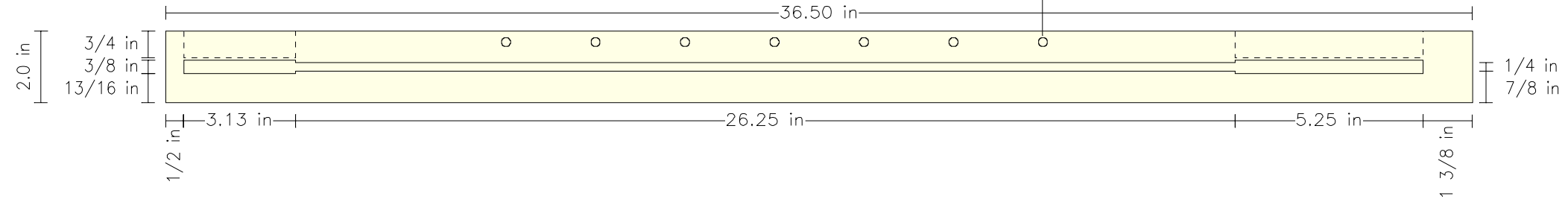

Side View

Top

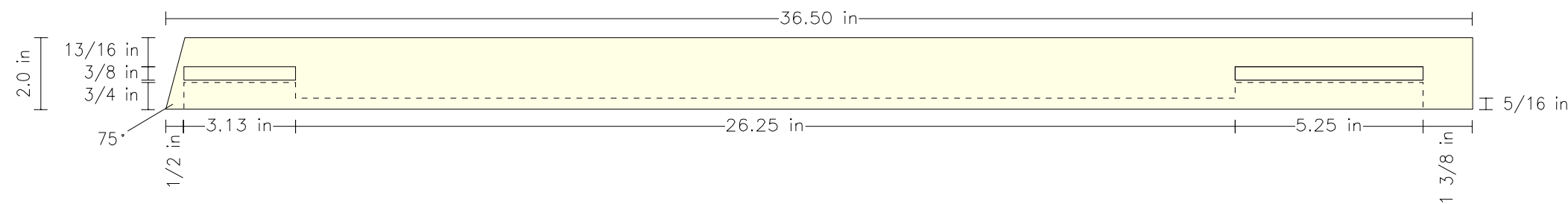

Note A : Left and right is given as seen when standing behind the lectern.

Note B : Shelf pin holes are optional and are only shown to illustrate their general position. The actual location of the holes (if installed) will depend on the diameter and length of the pins and the number of possible shelf positions that the builder wants to facilitate.

Left Rear Leg

Front View

Shelf Pin Hole

1/4 in
7/8 in

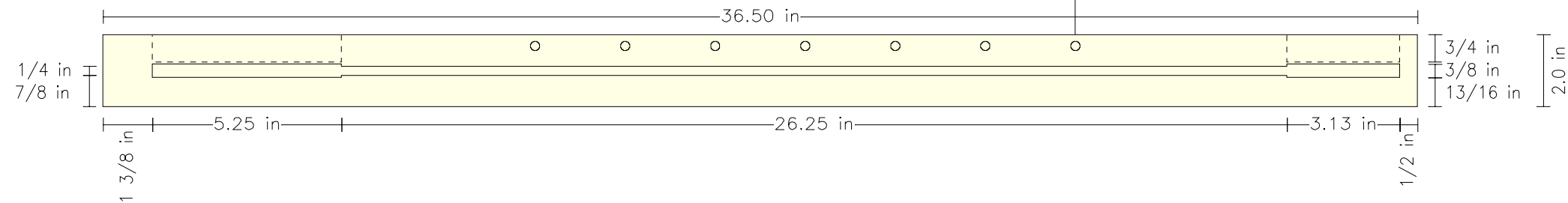

Top

Side View

5/16 in

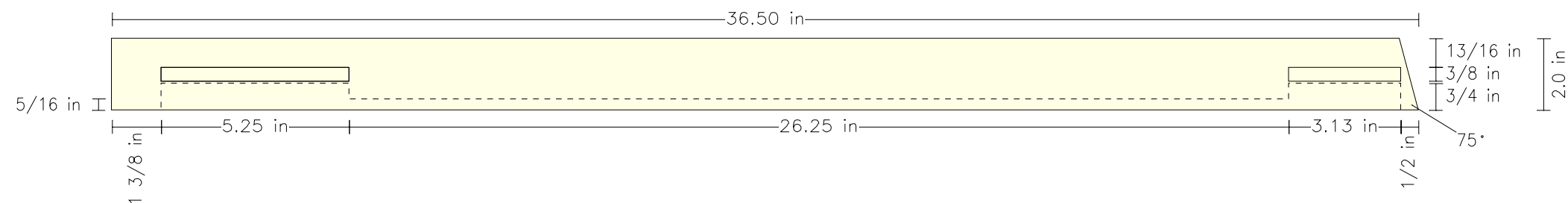

Top

Right Upper Side Rail

Side View

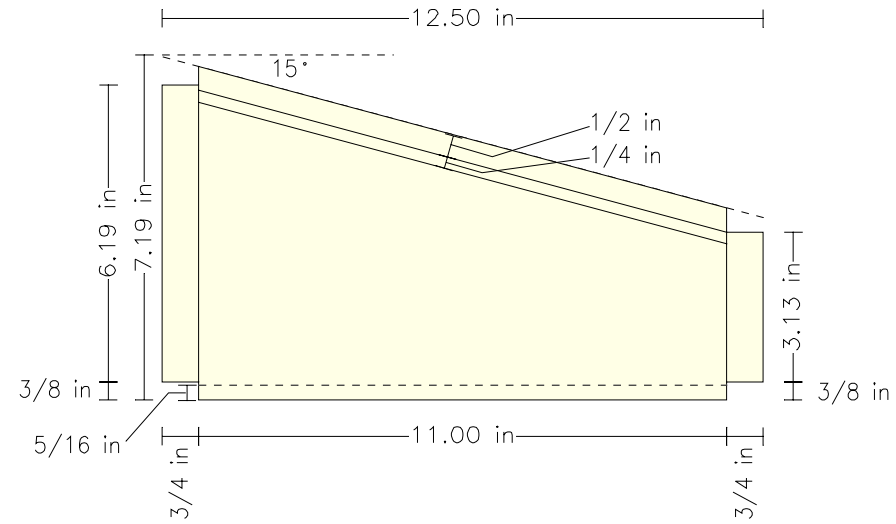

Front View

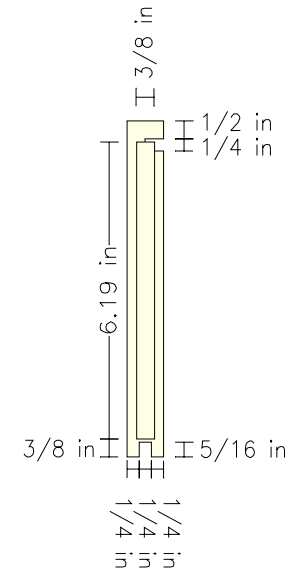

Rear View

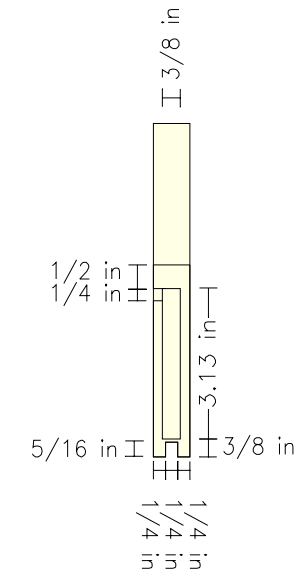

Left Upper Side Rail

Side View

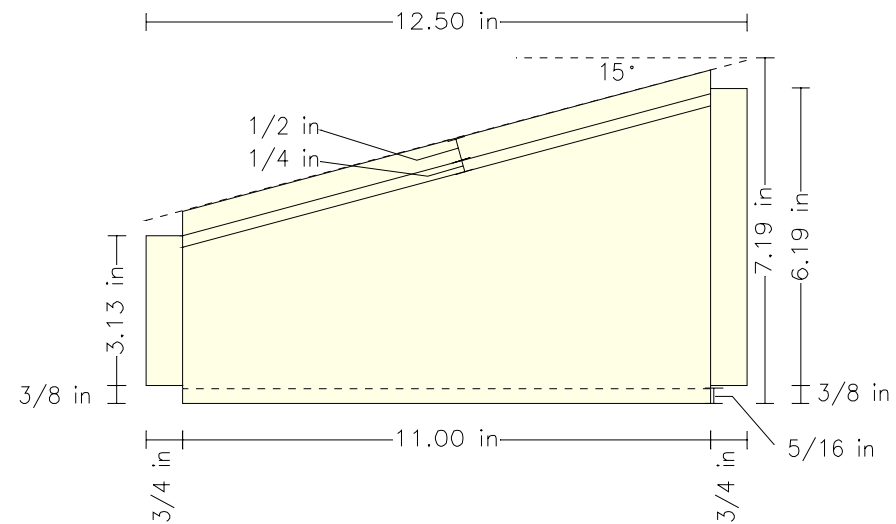

Front View

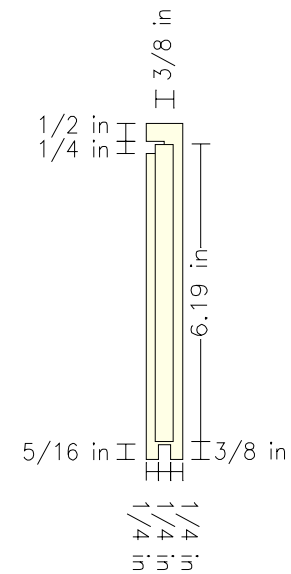

Rear View

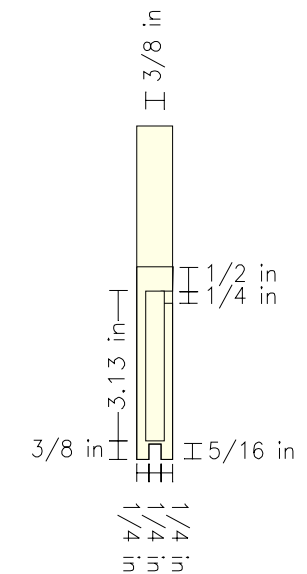

Lower Front Rail

Front View

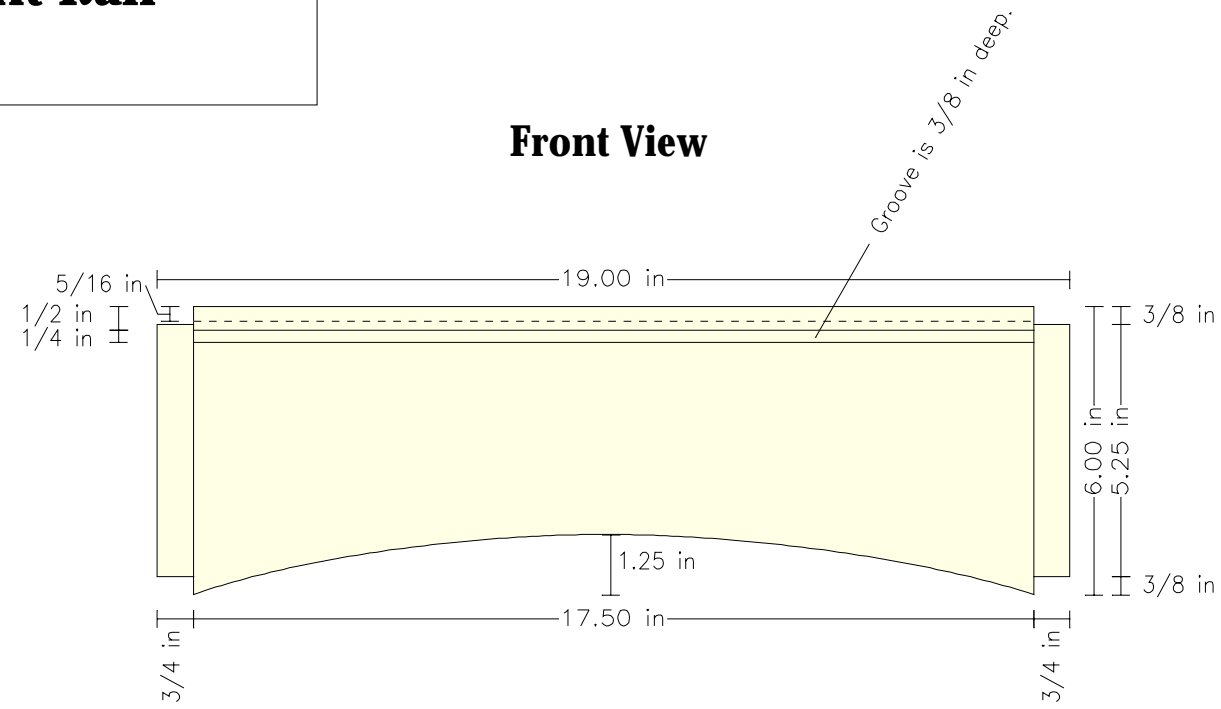

Side View

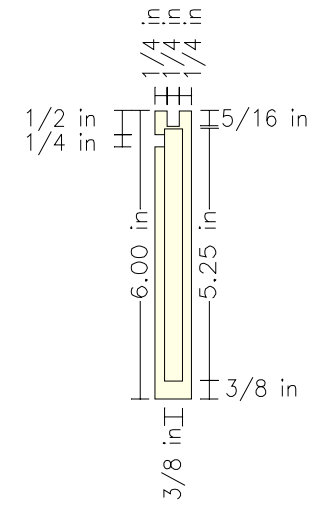

Lower Rear Rail

Front View

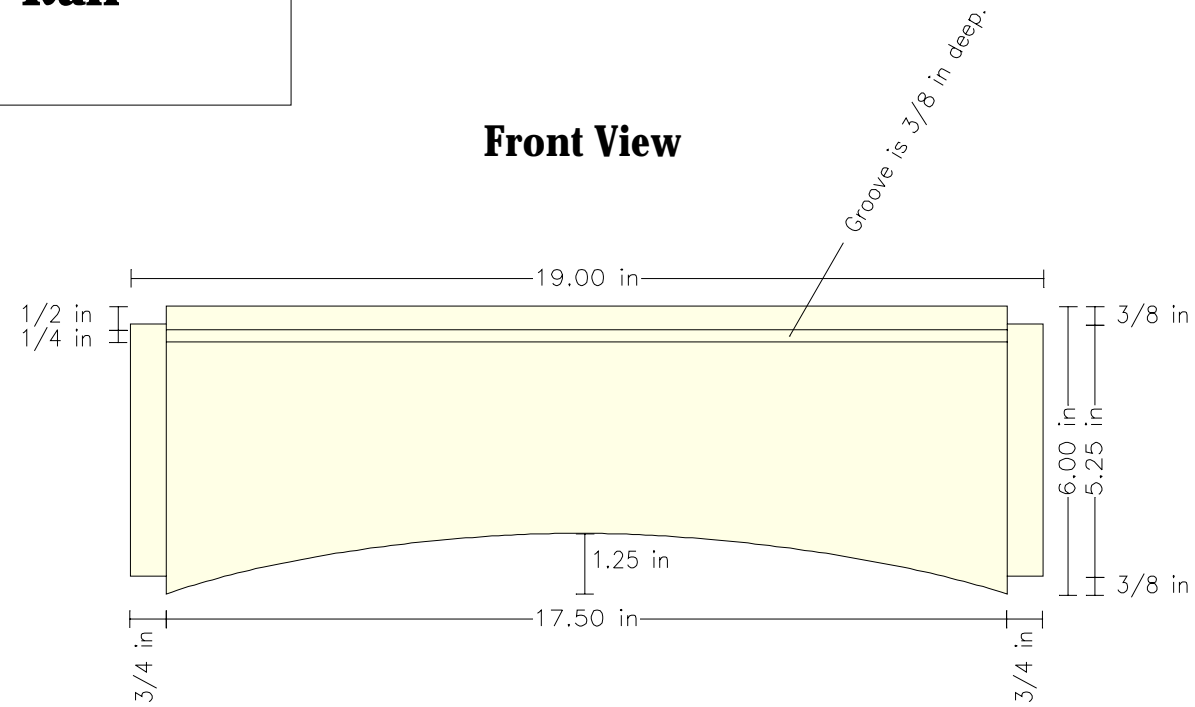

Side View

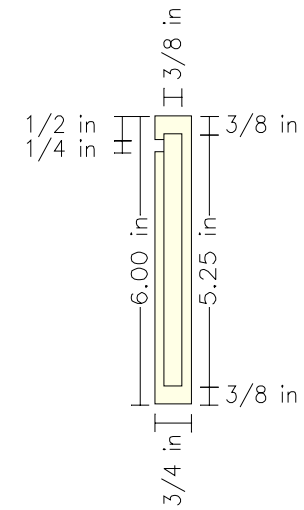

**Lower Side Rail
2 Each**

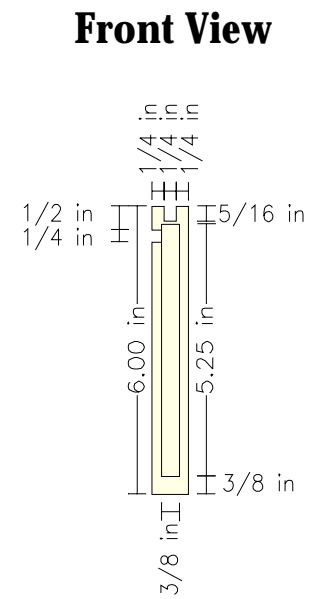
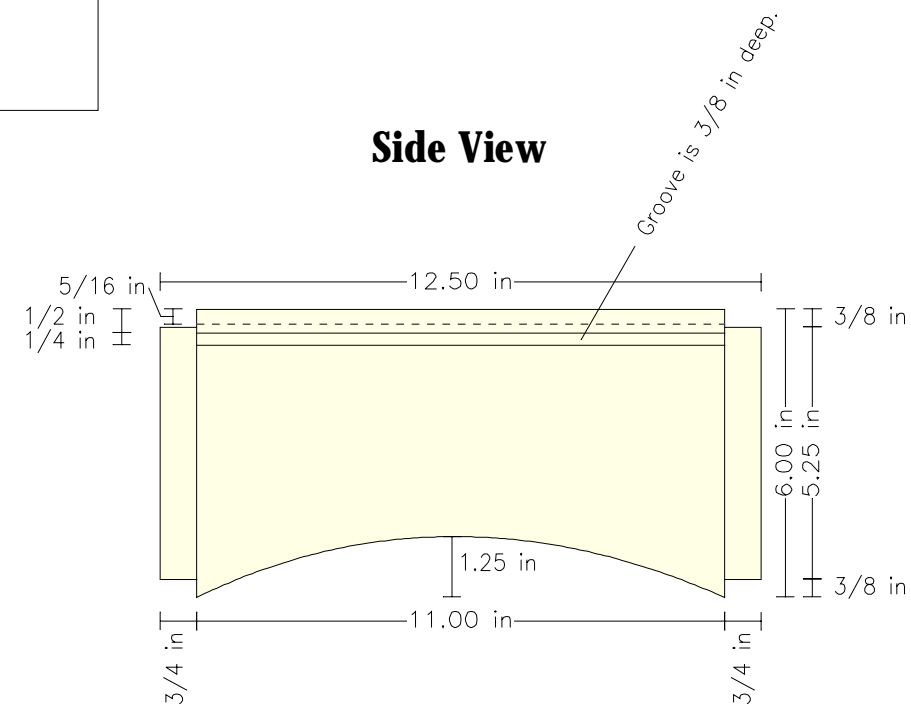

**Muntin
4 Each**

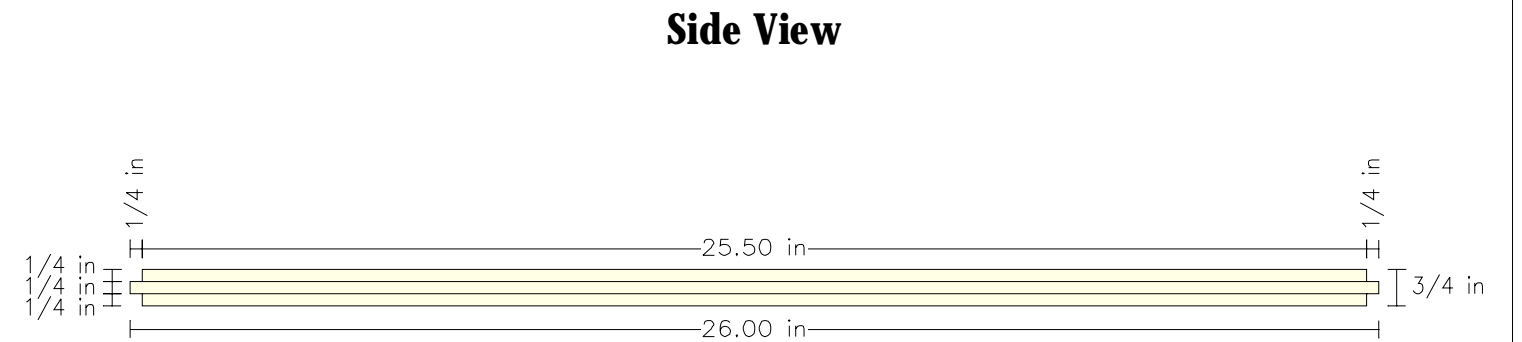
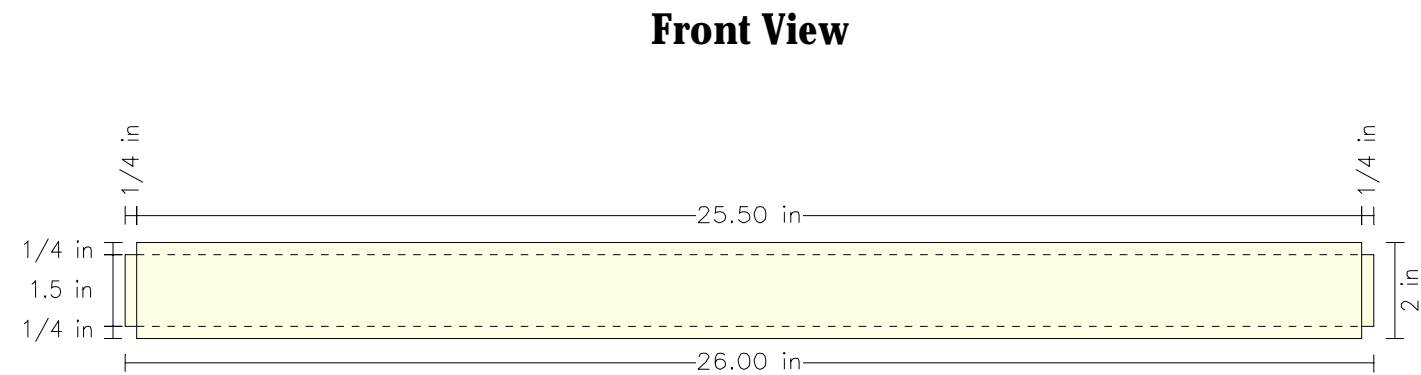

**Panel
7 Each**

Front View

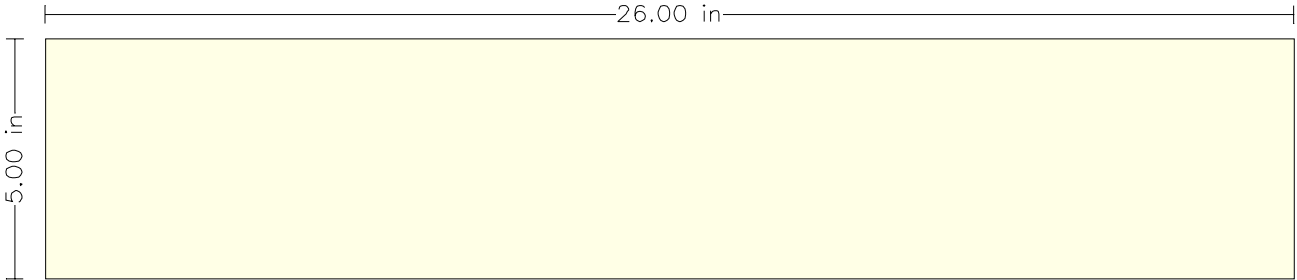

Side View

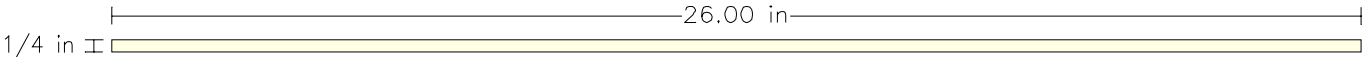

**Top Plank
2 Each**

Front View

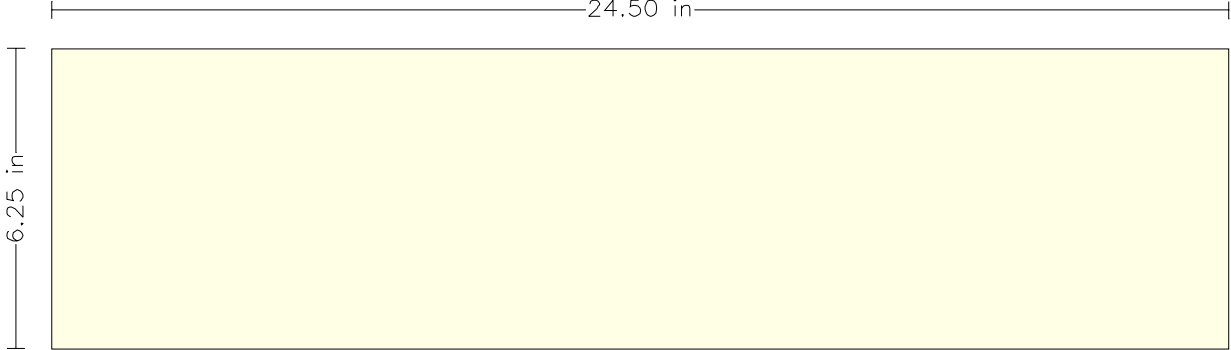

Side View

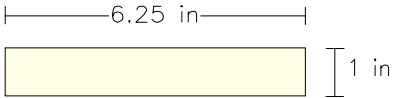

Grooved Top Plank (the ledge is inserted in the groove)

Front View

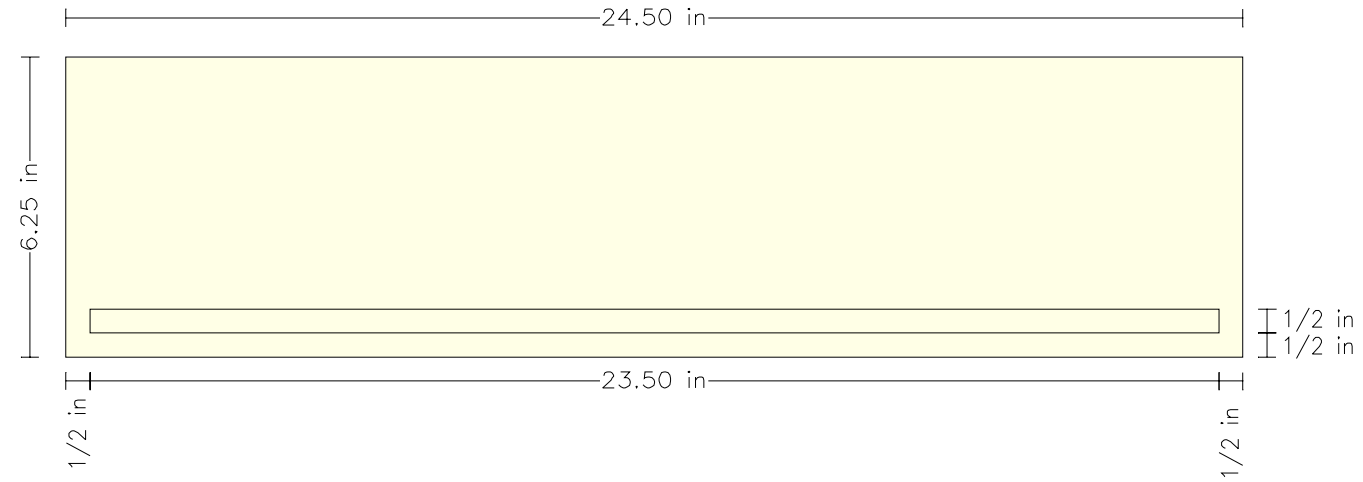

Side View

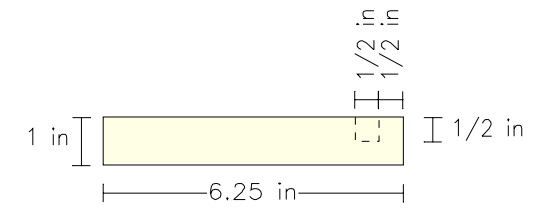

Ledge

Front View

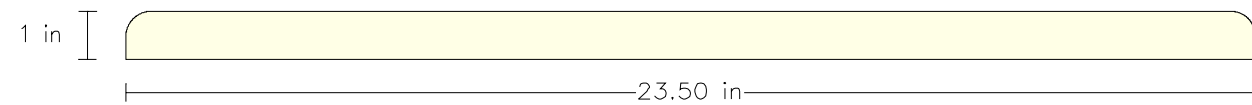

Side View

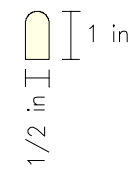

Bottom Shelf
(3/4 in cabinet grade plywood)

Top View

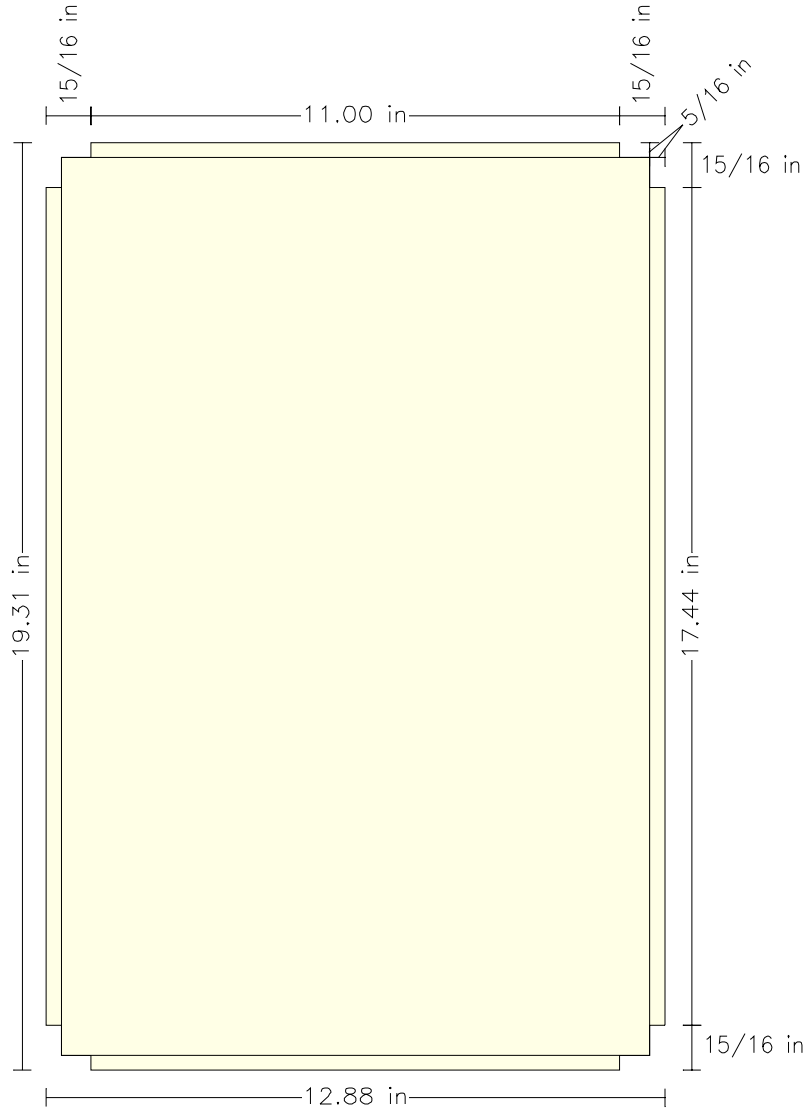

Front View

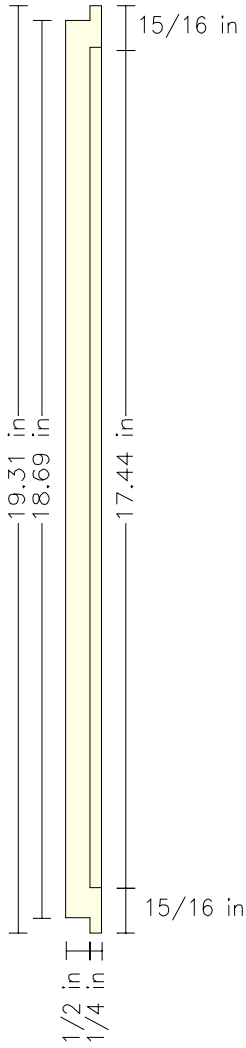

Side View

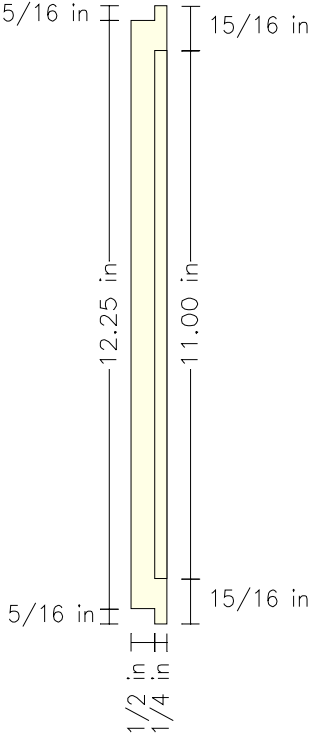

Wooden Clips

Attaches Tabletop to Lectern Cabinet

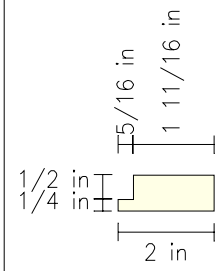

Top View

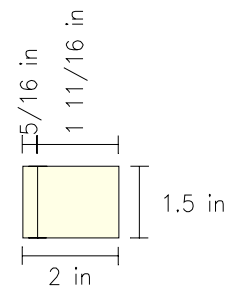

Side View

Exploded Diagram of Wooden Clips

