

END ELEVATION  
SCALE  $\frac{1}{8}'' = 1'-0''$

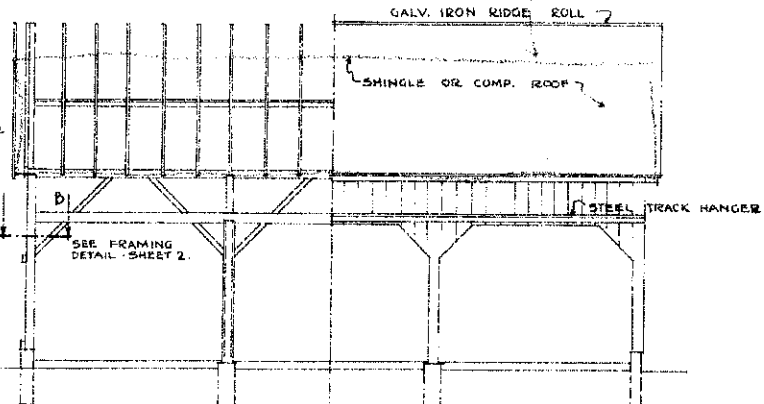

FRONT ELEVATION

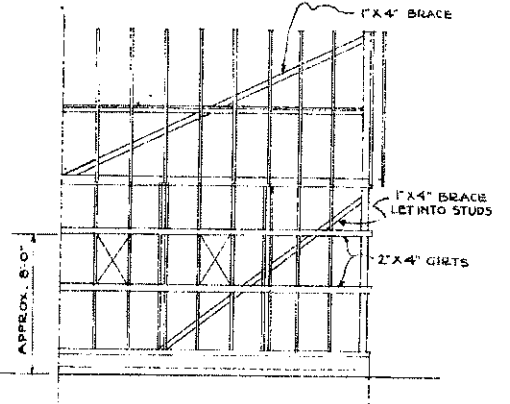

FRAMING DIAGRAM OF REAR WALL  
SCALE  $\frac{1}{8}'' = 1'-0''$

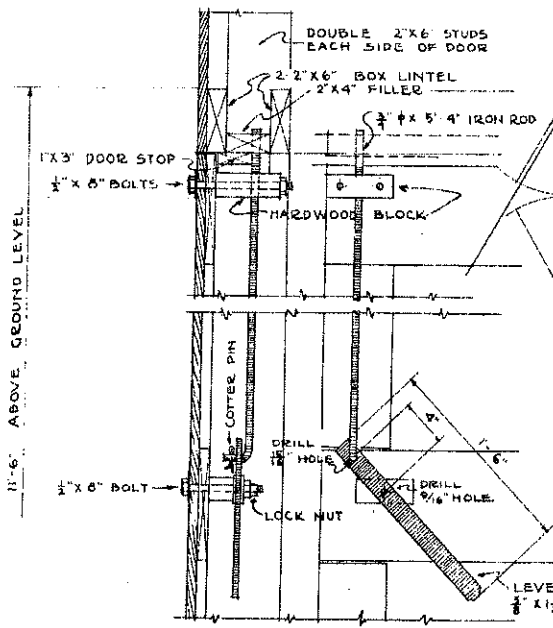

SECTION INSIDE ELEVATION  
DETAIL OF LOCKING DEVICE FOR SWINGING DOOR  
SCALE  $1\frac{1}{2}'' = 1'-0''$

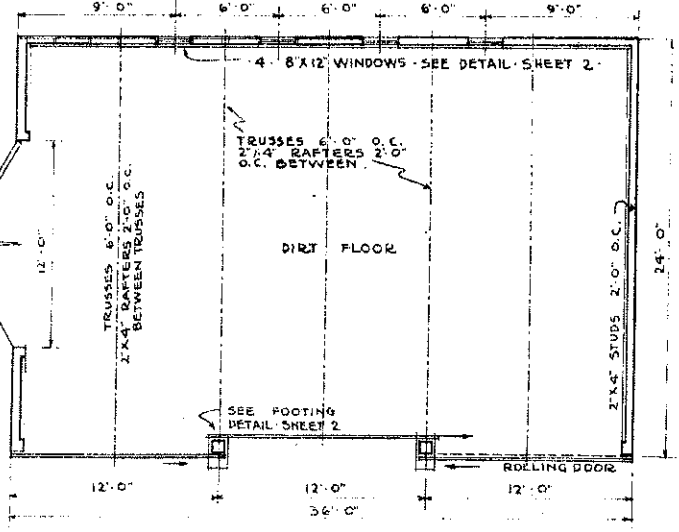

PLAN  
SCALE  $\frac{1}{8}'' = 1'-0''$

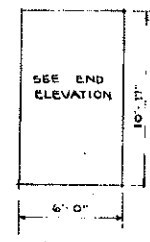

HINGED DOOR

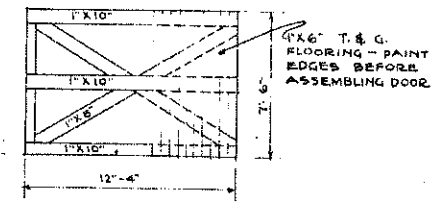

SLIDING DOOR  
SCALE  $\frac{3}{16}'' = 1'-0''$

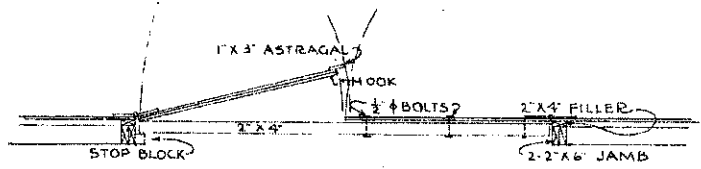

BAR FOR BOTTOM OF HINGED DOORS  
SCALE  $\frac{3}{8}'' = 1'-0''$

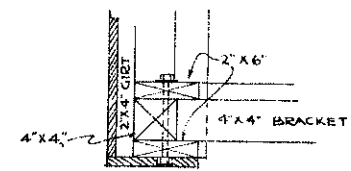

DETAIL CORNER POST (SECT B-B)  
SCALE  $1\frac{1}{2}'' = 1'-0''$

COOPERATIVE EXTENSION WORK IN  
AGRICULTURE AND HOME ECONOMICS  
STATE OF NORTH DAKOTA  
NORTH DAKOTA AGRICULTURAL COLLEGE  
AND  
U. S. DEPT. OF AGRICULTURE COOPERATING  
EXT. AGR. ENGINEER- FARGO, N. DAK.  
**MACHINERY SHED**  
MIDWEST 74 2233 EX. 5339 SHEET 1 OF 2

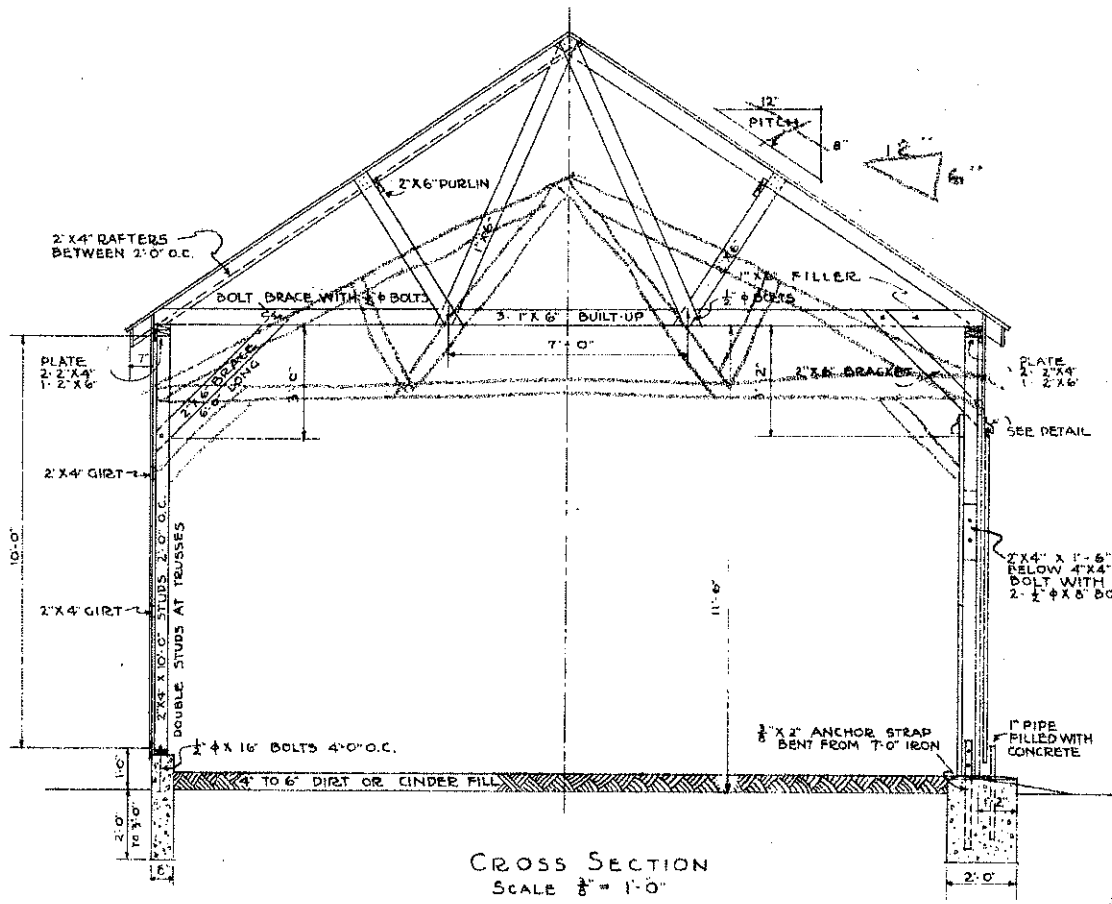

CROSS SECTION  
SCALE 3/8" = 1'-0"

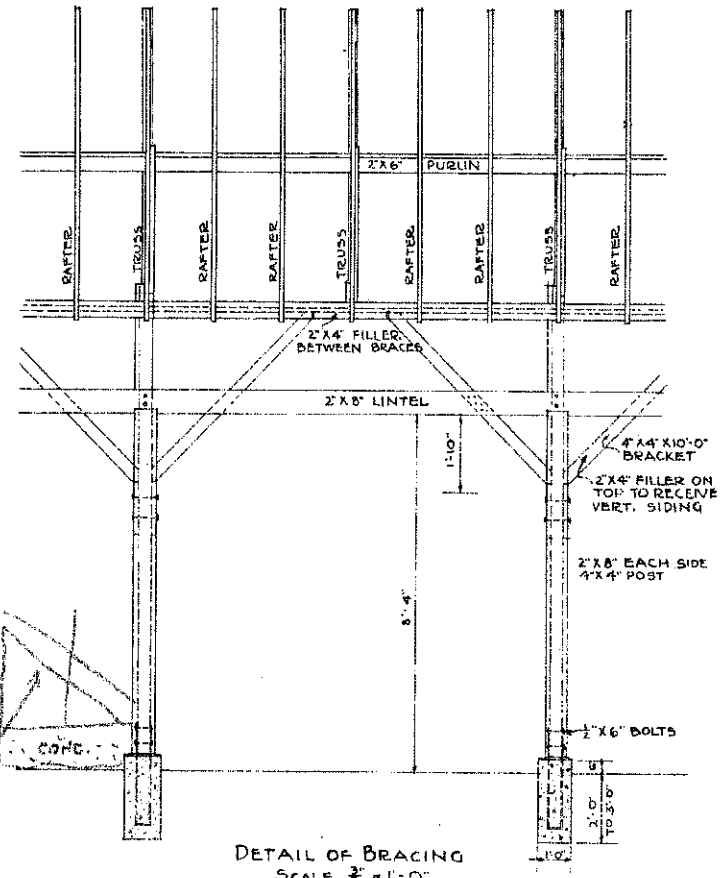

DETAIL OF BRACING  
SCALE 3/8" = 1'-0"

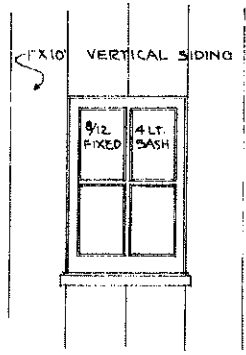

ELEVATION  
SCALE 1/2" = 1'-0"

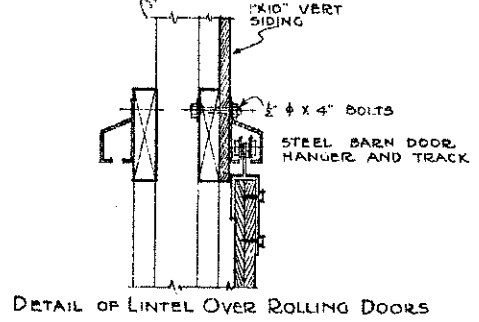
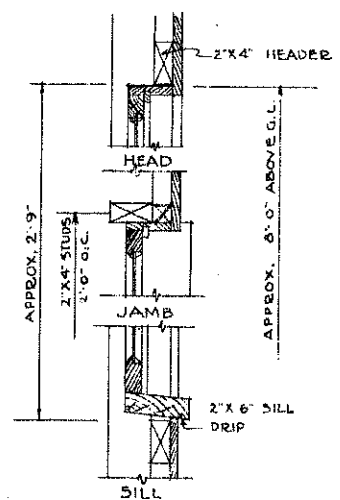

DETAIL OF LINTEL OVER ROLLING DOORS

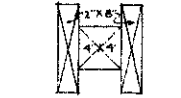

PLAN OF POST  
SCALE 1 1/2" = 1'-0"

COOPERATIVE EXTENSION WORK IN  
AGRICULTURE AND HOME ECONOMICS  
STATE OF NORTH DAKOTA  
NORTH DAKOTA AGRICULTURAL COLLEGE  
AND  
U. S. DEPT. OF AGRICULTURE COOPERATING  
EXT. AGR. ENGINEER- FARGO, N. DAK.  
**MACHINERY SHED**  
MIDWEST 74122-33 EX. 5340 SHEET 2 OF 2