

## Bar

An attractive free-standing bar that's just right for entertaining. It's easy to build from strong, good-looking plywood. Six-foot long bar features lots of storage space for bottles and glasses, a large illuminated work counter and four spacious drawers for those all-important bar accessories. Stiffness of all parts is assured with CANPLY Douglas Fir plywood.

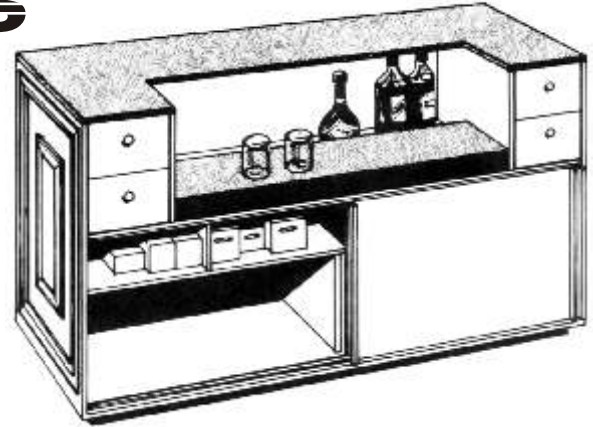

### HOW TO BUY PLYWOOD

Plywood is available in a variety of grades, one of which is just right for this project. The correct grade is shown in the materials list.

CANPLY Douglas Fir plywood with two faces of the highest appearance (Good Two Sides grade) is specified where both sides of the panel will be seen in the finished job. Faces of this grade, which may contain carefully made repairs, are smooth and easy to paint. Select plywood with uniform grain pattern and colouration if you intend to use a light stain finish.

Where only one side of the panel will be seen once the project is completed, Good One Side grade is specified for economy.

Medium Density Overlaid (MDO) plywood with a resin impregnated fibre overlay may be used as an alternative to Good Two Sides when an extremely high quality paint finish is desired.

Douglas Fir plywood stamped with the registered certification marks shown below is manufactured with waterproof glue by members of the Canadian Plywood Association. These marks are positive indications by the manufacturer that the plywood has been produced in conformance to the specifications of Canadian Standards Association and CANPLY's rigid quality standards.



## Material List

Recommended plywood: CANPLY Good One Side (G1S) or Good Two Sides (G2S)

### PLYWOOD:

Quantity:	Description
4 panels	19mm x 1220mm x 2440mm (4 ft x 8 ft) Good One Side plywood
4 pieces	6mm 18" x 9 5/8" plywood (drawer bottoms)

### OTHER MATERIALS

Quantity	Description
2 pieces	2" x 4" x 6' Fir (base frame)
1 piece	2" x 4" x 4' Fir (base frame)
36 ft	3/4" x 3/4" Fir (shelf ledgers, drawer slides, bar top retaining strips)
2 pieces	3/4" x 6' plastic sliding door track
1	48" fluorescent light fixture
1	50" x 15" translucent plastic light cover
1 lb	1 1/4" finishing nails
1 lb	1 1/2" finishing nails
As required (bar top)	Vinyl upholstery fabric or plastic laminate overlay as desired Decorative wood mouldings as desired (front and ends) Drawer and sliding door hardware as desired Glue, wood filler, sandpaper, paint or stain

### CONSTRUCTION NOTES

The cutting diagram shows a basic bar unit. It can be painted, stained or overlaid wholly or in part with vinyl fabric, plastic laminate or similar materials. It can be decorated on the front and sides with various moulding patterns. If mouldings are used for decoration, the bar top should be enlarged so that it extends to cover the edges of the mouldings.

If the final finish is to be a stain or natural finish, care will be required when gluing and finishing. Beads of glue caused by excessive glue squeeze-out, and dents and gouges caused by careless handling cannot be covered by stain.

Cut and assemble the 2" x 4" base frame to the dimensions shown. Large furniture glides or castors on the bottom of the frame will make it easier to move the bar to different locations. Select the best looking sections of the plywood panels for the front, ends, and sliding doors. Cut out the front, two ends, and bottom. Attach the front to the ends (by nail-gluing), turn the partial assembly upside down and attach the bottom. Next centre the unit on top of the 2" x 4" frame and nail through the plywood into the frame.

Cut out the shelf, the working counter, the shelf support, and the counter supports. Install the shelf and working counter, supporting both on  $\frac{3}{4}$ " x  $\frac{3}{4}$ " ledgers at each end (set supports back 2" from edge). Install the shelf and counter supports making sure the shelf, shelf support, counter supports, and the  $\frac{3}{4}$ " x  $\frac{3}{4}$ " members are set back 2" from the edge to leave room for the sliding door hardware.

Install the sliding door track on the bottom and on the underside of the working counter flush with the back of the unit. Cut and install the sliding doors, making sure to check the measurements carefully. A little wax on the edges of the sliding doors will make them slide easier.

Cut and install the working counter sides and counter side braces.

The four drawers are next. These can be made and mounted in various ways. The plan shows a simple butt-joint with the drawer sides routed out to permit them to slide on  $\frac{3}{4}$ " x  $\frac{3}{4}$ " supports. The construction and mounting of the drawers is probably the trickiest part of the project and care should be taken to check the measurements and fit at all stages. The final result should see the drawer fronts flush with the back of the unit and the drawers centred so as to provide an even space of approximately  $\frac{1}{8}$ " at the sides and at the top and bottom.

The light fixture, a 48" single tube 40 watt fluorescent, is mounted on the inside of the front panel centred directly in line with the opening at the back of the working counter.

The translucent plastic cover may be attached directly to the back of the counter and the counter sides or may be mounted with small wooden mouldings on the back of the counter between the counter sides. The light cord can be brought out through a convenient corner of the floor panel between the end and the base of the unit.

The raised working counter is next. It consists of three pieces as shown and can be fastened from underneath directly to the counter top or simply placed over two small  $\frac{3}{4}$ " x  $\frac{3}{4}$ " blocks cut to fit between the side supports and fastened to the counter top. If this is done, it can be removed as required.

The next step is to cut the top. If decorative moulding is planned, make the top larger than 72" x 27" to bring it flush with the mouldings.

Install the  $\frac{3}{4}$ " x  $\frac{3}{4}$ " retaining strips around the underside of the top. Notch strips to slot over counter side braces. These strips should be set back  $\frac{3}{4}$ " from the plywood edge. This makes it easy to remove the top to replace the light tube.

The top and working counter can be attractively finished with a vinyl upholstery material. If this is done, the vinyl should be applied with a suitable adhesive to the top and working counter before they are installed. The material can be wrapped around and under all edges.

Additional glass storage may be obtained by installing a glass shelf in one-half of the recessed area behind the working counter top.

The final finishing consists of filling, sanding, painting, staining and the attachment of suitable hardware for the drawers and sliding doors.

## BUILDING HINTS

These general hints are designed to help you achieve the best possible results in working with plywood. They apply not only to this plan, but to all projects you may undertake that include CANPLY plywood. Since building methods and interpretation of suggestions may vary, CANPLY cannot accept responsibility for results of an individual's project efforts.

**Planning:** Before starting, study the plan carefully to make sure you understand all details.

**Making layout:** Following the panel layout, draw all parts on the plywood panels using a straightedge and a carpenter's square for accuracy. Use a compass to draw corner radii. Be sure to allow for saw kerfs when plotting dimensions; if in doubt, check the width of your saw cut.

**Cutting:** For hand-sawing use a 10 to 15 pt. cross-cut. Support panel firmly with good face up. Use a fine-toothed coping saw for curves. For inside cuts start hole with drill then use coping or keyhole saw. For power sawing a plywood blade gives best results, but a combination blade may be used. Panel face down for hand power sawing. Panel face up for table power sawing. With first cuts reduce panel to pieces small enough for easy handling. Use of scrap lumber underneath panel, clamped or tacked securely in place, prevents splintering on back side. Plan to cut matching parts with same saw setting. If available, you may use a jigsaw, bandsaw, or saber saw for curved cuts. In any case be sure blade enters face of panel.

**Drilling:** Support plywood firmly. For larger holes use brace and bit. When point appears through plywood, reverse and complete hole from back. Finish slowly to avoid splintering.

**Planing:** Remember, edge grain of plywood runs in alternate directions so plane from ends towards centre. Use shallow-set blade.

**Sanding:** Most sanding should be confined to edges with 80 or finer sandpaper before sealer or flat undercoat is applied. You may find it easier to sand cut edges smooth before assembling each unit. Plywood is sanded smooth in manufacture – one of the big time-savers in its use – so only minimum surface sanding is necessary. Use 120 sandpaper in direction of grain only, after sealing.

**Assembly:** Assemble by sections; for example, drawers, cabinet shells, compartments – any part that can be handled as an individual completed unit. Construction by section makes final assembly easier. For strongest possible joints, use a combination of glue and nails (or screws); to nail-glue, check for a good fit by holding the pieces together. Pieces should contact all points for lasting strength. Mark nail locations along edge of piece to be nailed. In careful work where nails must be very close to an edge, you may wish to predrill using a drill bit slightly smaller than nail size. Always predrill for screws.

Nails may be casing or finishing. Casing nails are best wherever a heavier nail is needed. For exterior use always use corrosion-resistant nails. Nail length is determined by the thickness of plywood, as follows:

<b>Plywood</b>	<b>Nail</b>	<b>Screw</b>
6 and 8 mm	1 ½"	¾" and 1" No. 6
11 mm	1 ½" or 2"	1 ¼" No. 6
14, 17 and 19 mm	2"	1 ½" No. 8, 10, or 12

Apply glue to clean surfaces, according to manufacturer's instructions. Press surfaces firmly together until "bead" appears, then nail, check for square, and apply clamps if possible to maintain pressure until glue sets. For exterior exposure, use resorcinol-type waterproof glue; for interior work; use liquid resin (white) or urea resin type glues. (Other glues are available for special gluing problems.)

**Finishing for interior use:** MDO plywood needs no preparation and is finished with conventional paints for an exceptionally smooth and durable surface. Stain is not recommended for MDO plywood. Sanded panels require very little preparation, primarily "touch sanding" (in direction of grain only) to smooth any filler or spackle applied to minor openings in the panel face or to remove blemishes. Do not paint over dust, spots of oil, or glue. Any knots or pitch streaks should be touched up with sealer or shellac before painting.

Either water or oil-base paints can be used to get flat, semi-gloss, or gloss finishes. Some oil-base paints are self-priming; otherwise use recommended material.

Stains may be used to obtain a natural-looking finish of plywood's grain patterns and neatly made mechanical repairs. Two methods that give pleasing results are: colour toning, which uses companion stains and non-penetrating sealers; and light stain, which uses a pigmented sealer, tinting material (stain, thin enamel, or undercoat), and finish coat (varnish or lacquer).

Whatever finishing method you use paint or stain always use top quality materials, and follow the manufacturer's instructions.

**Finishing for exterior use:** Since edges of plywood absorb moisture rapidly unless sealed, coat edges thoroughly with a high-quality oil-base exterior paint primer (if unit is to be painted) or a good water-repellent preservative (if unit is to be stained).

For painting, always use a prime coat. Skimping on a primer can jeopardize the effectiveness of even the best top coats. Prime the unit just as soon as you can after assembly is complete. Use a primer that is compatible with the top coat you'll use. Water-base acrylic latex paints, with companion non-staining primers are easy to use and clean up and give excellent performance.

For rough or textured plywood, oil-base stains are the recommended finish. Semi-transparent stain provides maximum grain show-through as well as maximum display of surface texture, but leaves little surface film. Opaque stain hides grain pattern but not the texture. Stains should be applied in one or two coats, and, as with paints, give best performance if applied by brush. Brushing works the finish into the wood surface.

Whatever finishing method you use paint or stain always use top-quality materials, and follow the manufacturer's instructions.

# Exploded View

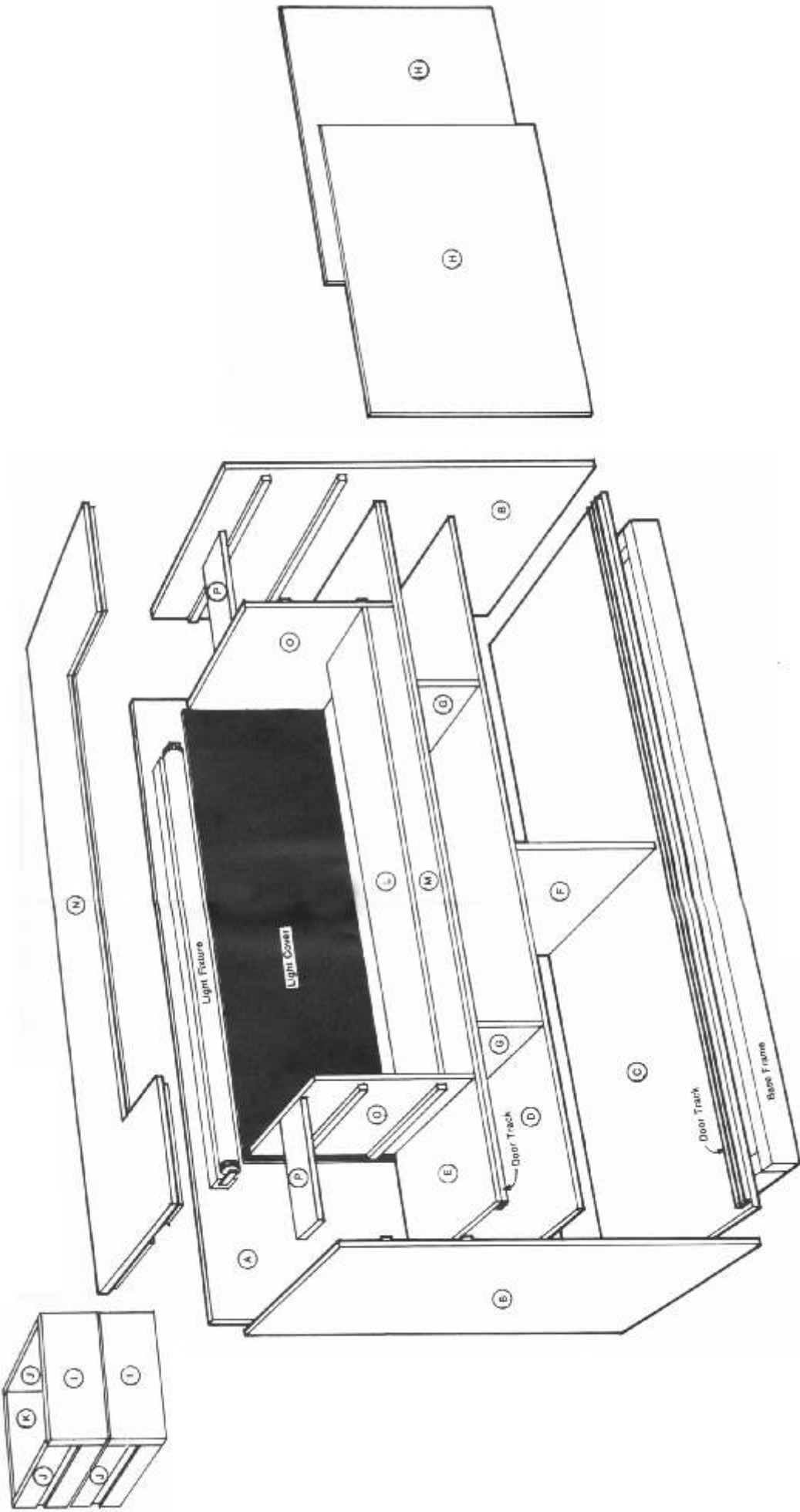

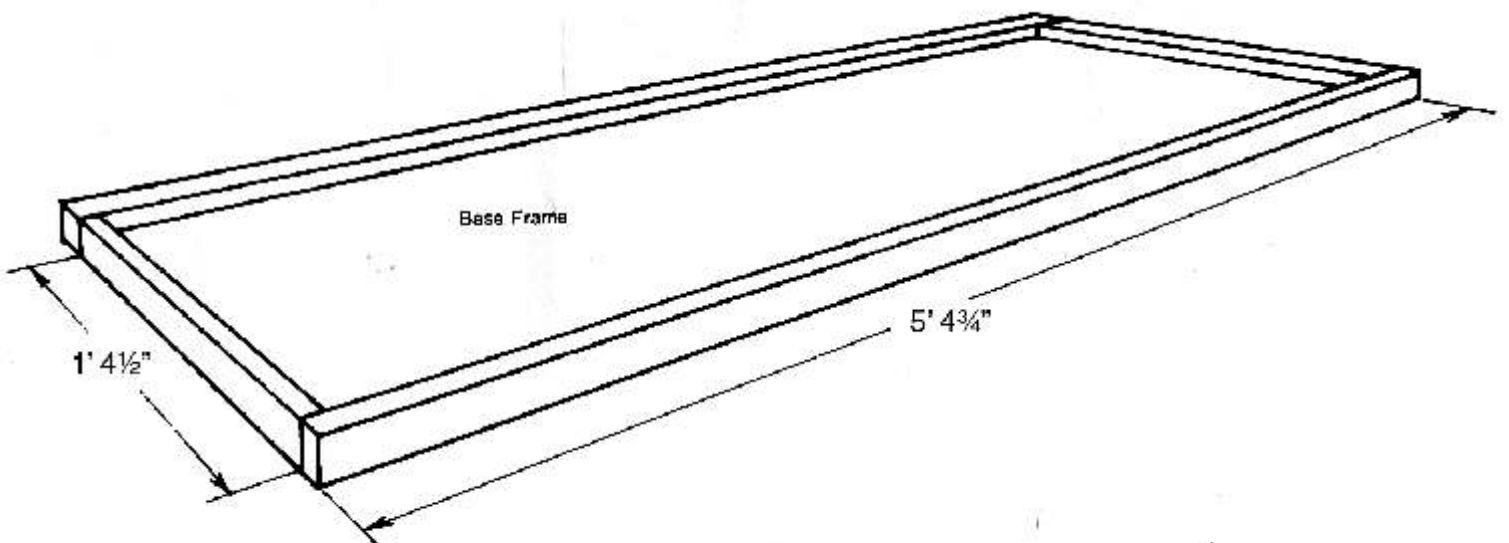
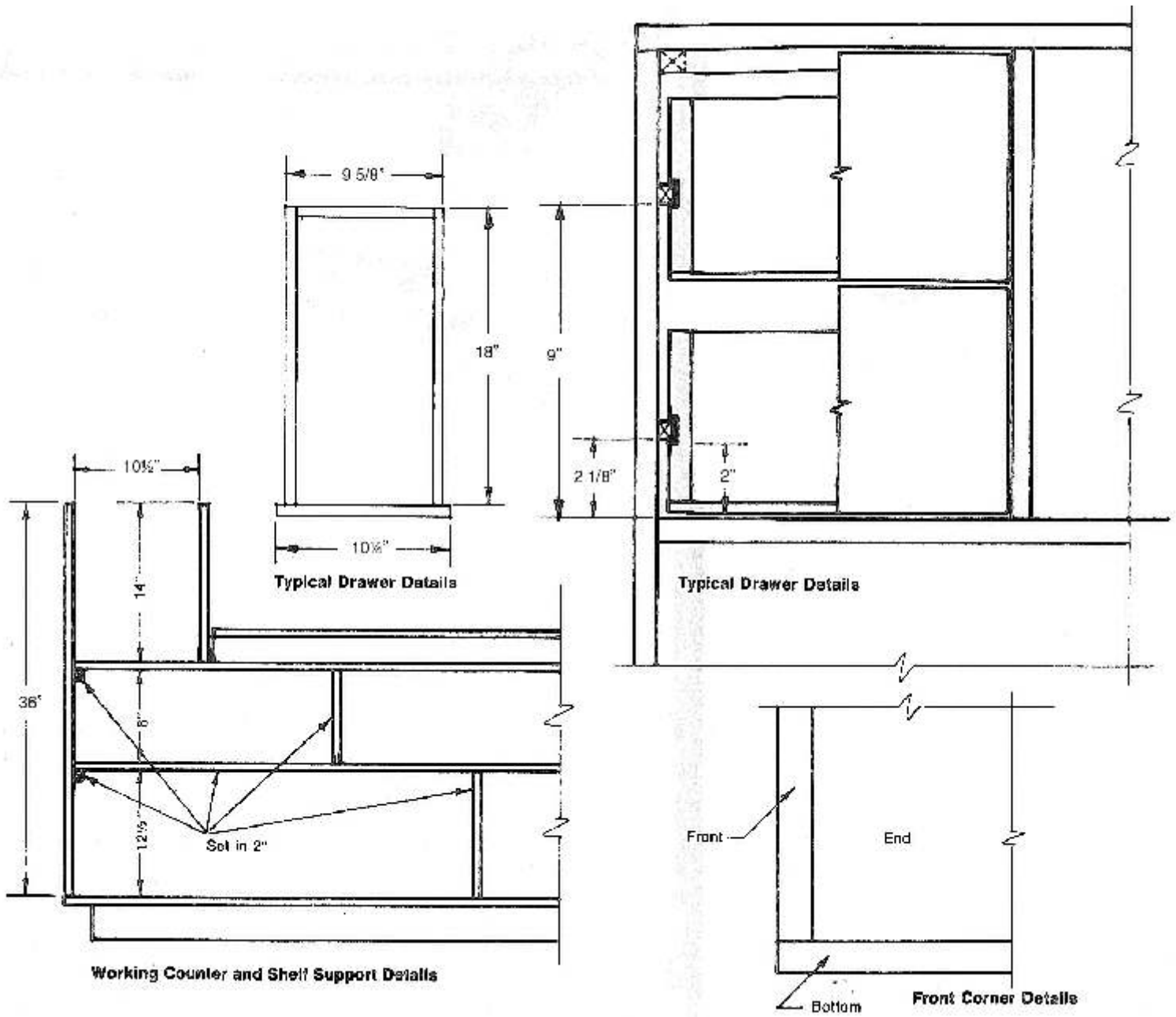

# CUTTING DIAGRAMS

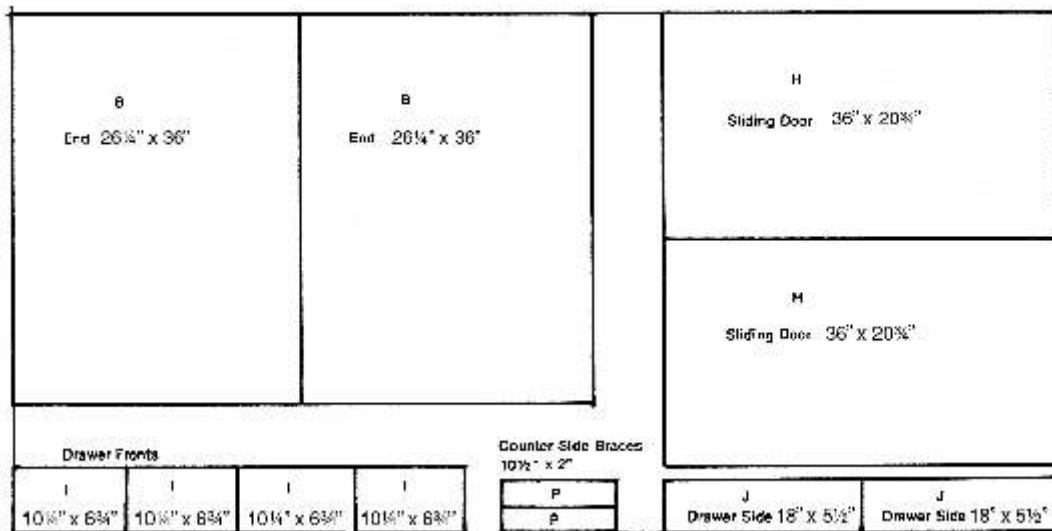
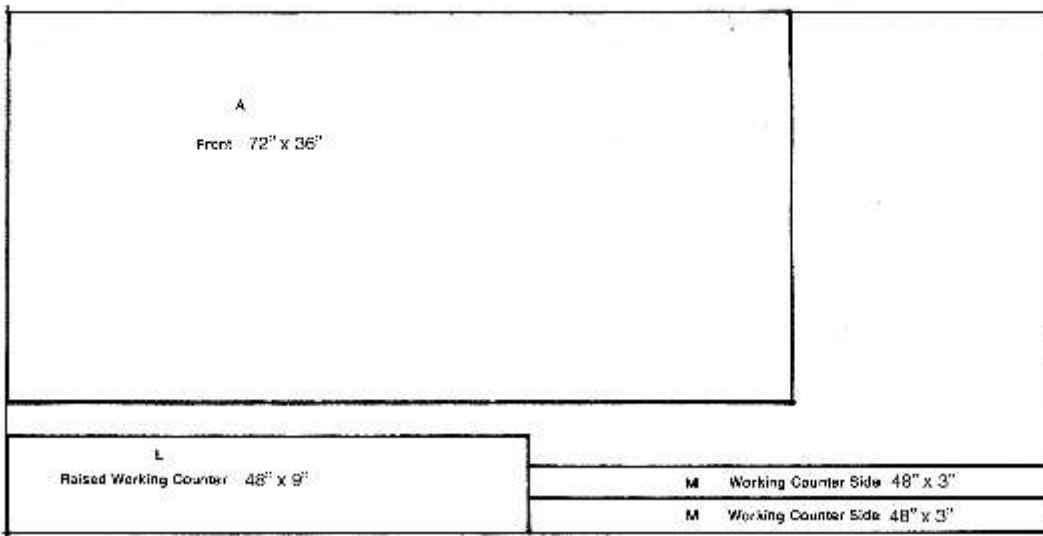
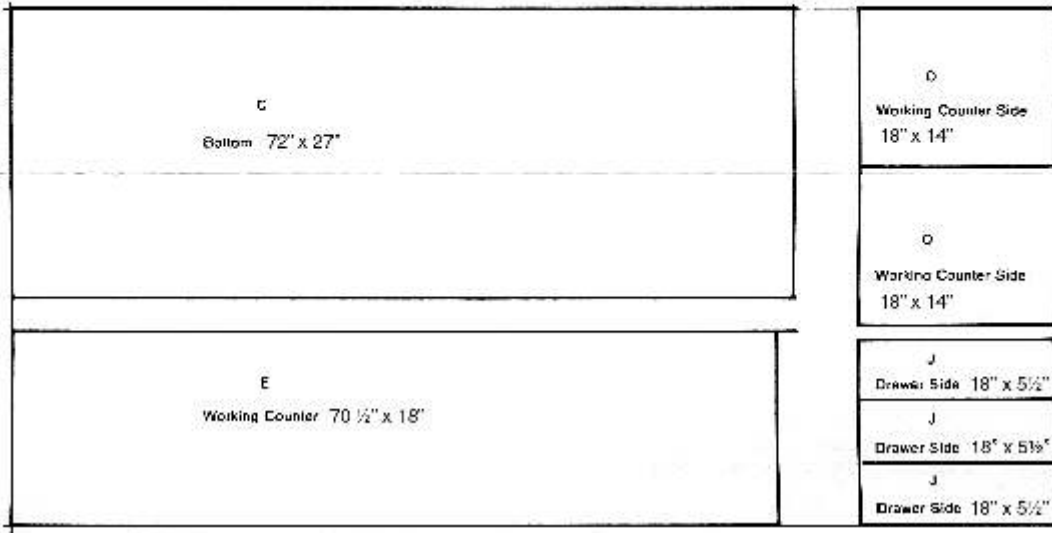

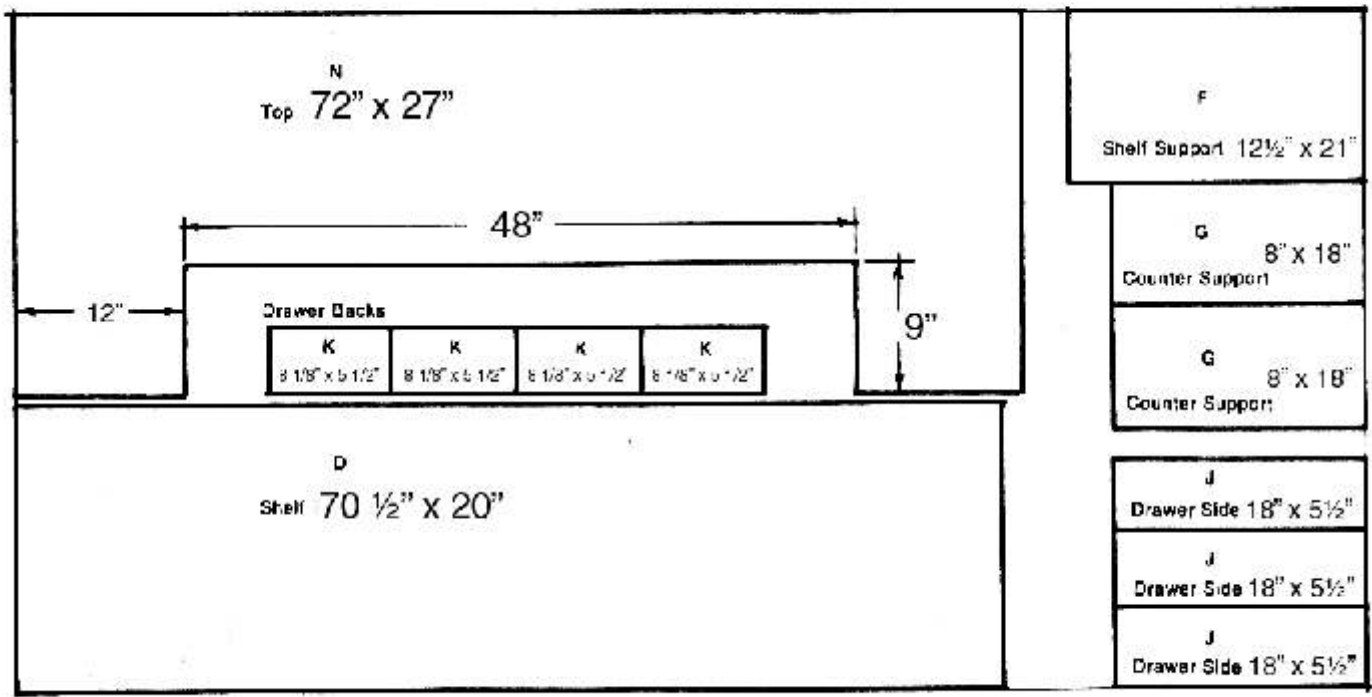

DECORATIVE SUPERGRAPHICS

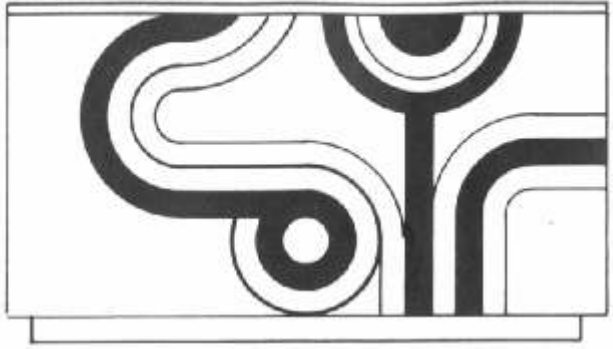

DECORATIVE MOULDING

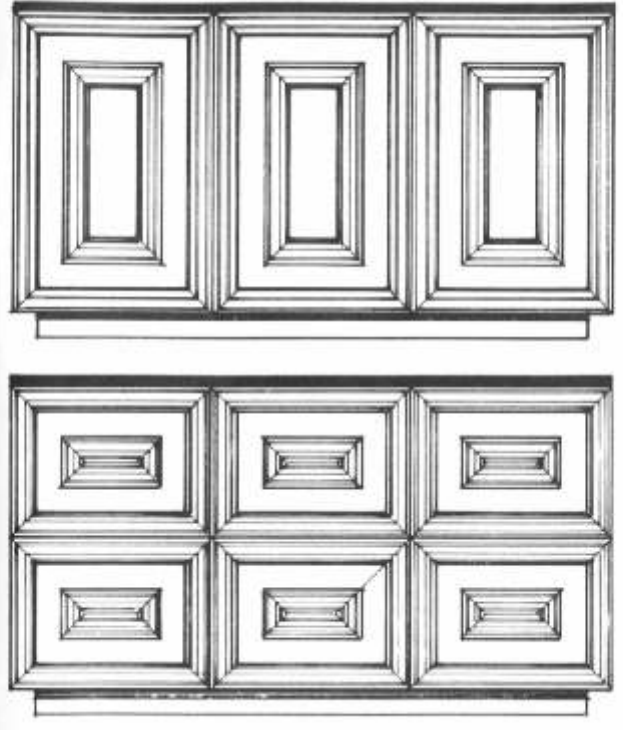

Although every effort has been made to ensure that all data in this Ply Plan are accurate, CANPLY shall not be responsible for any injury, damage or loss, however caused arising from the use of the information provided.