

Start to Sketch and Doodle

1st
GRADE

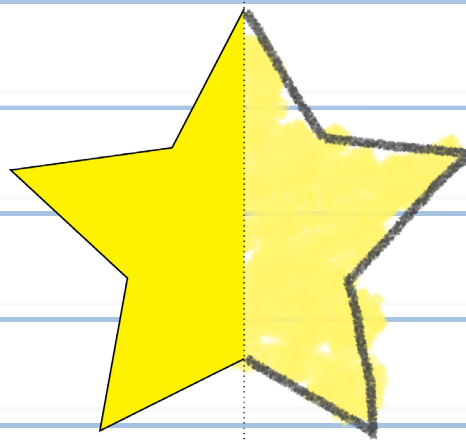
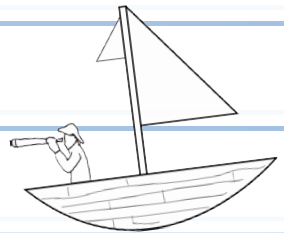
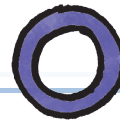
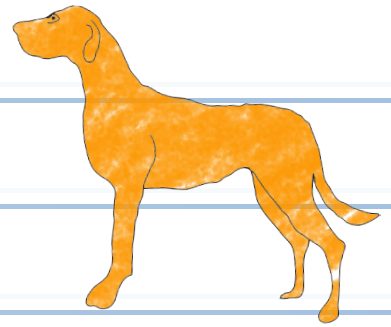
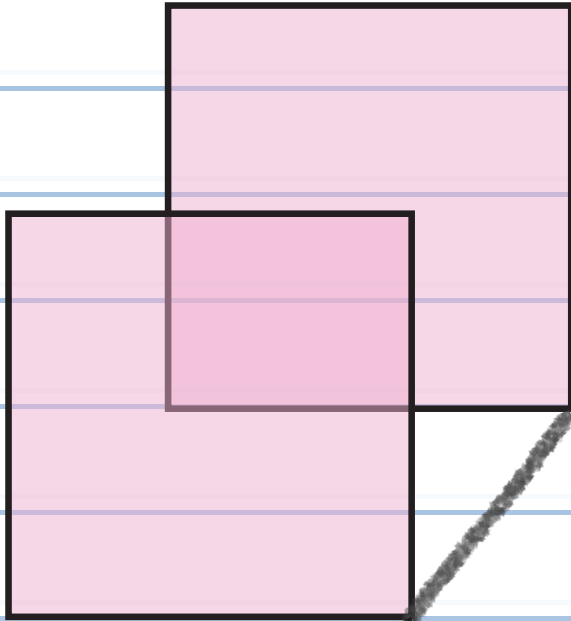

Table of Contents

Start to Sketch and Doodle

Numbers: Turn Numbers Into Drawings

Squiggles: Turn Squiggles Into Drawings

Roman Numerals

Facial Expressions

Alphabet Alliteration

Getting Around

Counting

Pointillism

Colors: Learn How Colors Work

Colors: Mixing Colors

3-Dimensional Shapes

Symmetry

Rulers Rule

Drawing a Tree

Certificate of Completion

Want more workbooks? Join Education.com Plus to save time and money.
<http://www.education.com/education-plus/>

NUMBERS: Turn numbers into drawings!

Take the shapes of the numbers 0 - 9 and see how many drawings you can make out of them! Here are some examples.

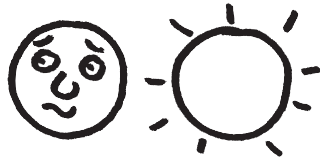

0 is nothing so it can be anything.



1 is half of a house.



2 is a snake that doesn't want to be stepped on.



3 is gymnasts practicing.



4 can be made with your arms.

5



5 is a vicious cat.

6



6 likes to roll around and turn into 9.

7



7 is almost a triangle.

8



8 is a snowman that isn't finished.

9



9 likes to roll around and turn into 6.

SQUIGGLES: Turn squiggles into drawings!

Make any squiggly line and then try to find if there are any parts that look like something. In the squiggly line below we made a shoe, a bird and a person. Can you make anything else?

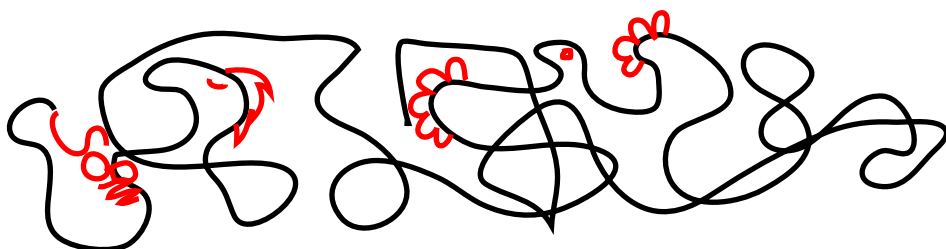

Try This

Have a friend draw a quick scribble and then try to make his scribble into a drawing of a creature.



ROMAN NUMERALS

C

100

D

50

X

10

V

5

I

1

When writing Roman numerals, write the largest number first and add them up. If a smaller number comes before a bigger number, subtract it.

III = 3

IV = 4

VI = 6

VII = 7

Now write your age in Roman numerals!

FACIAL EXPRESSIONS: Our expressions tell people what we're feeling.

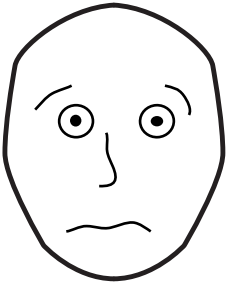

Embarrassed

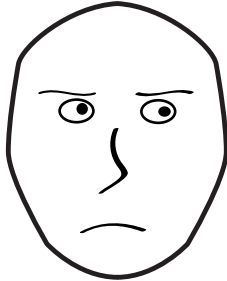

Bored

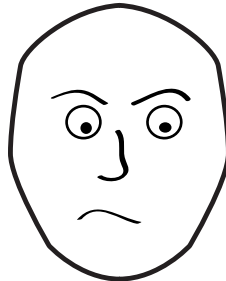

Annoyed

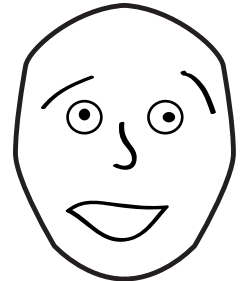

Excited



Crying

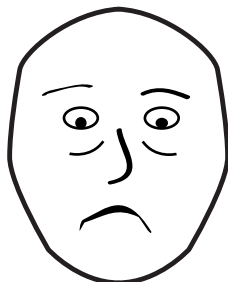

Sad

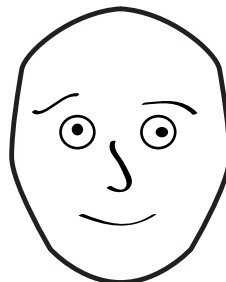

Happy

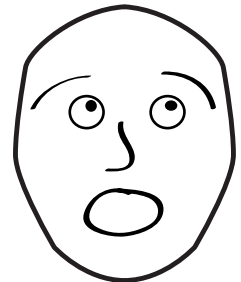

Surprised

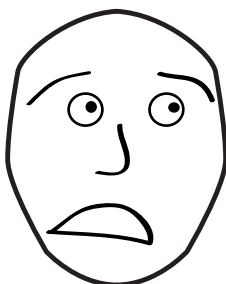

Scared

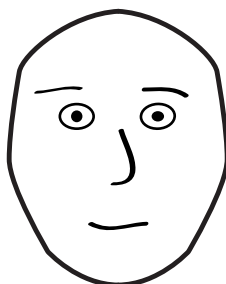

Calm

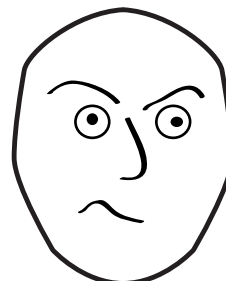

Angry

FACIAL EXPRESSIONS: Use these empty heads to draw your own faces! Don't forget the eyebrows—they can be the most important part.

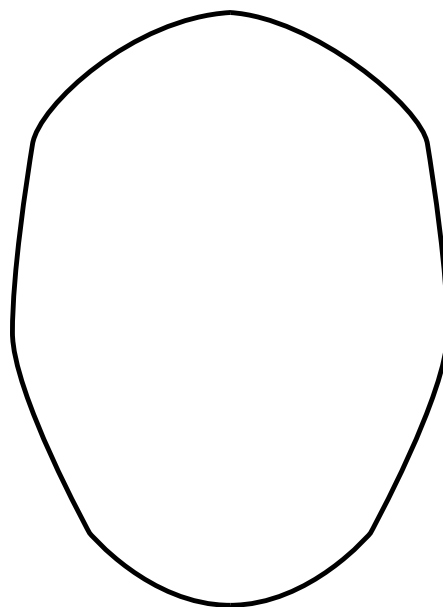
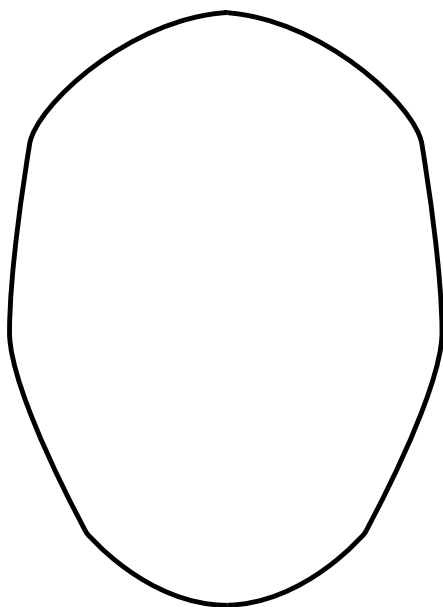
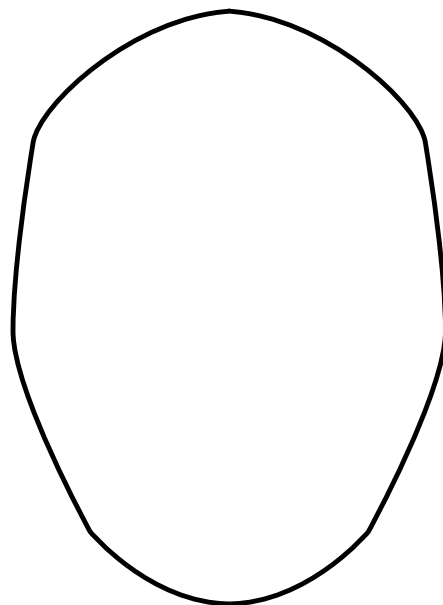
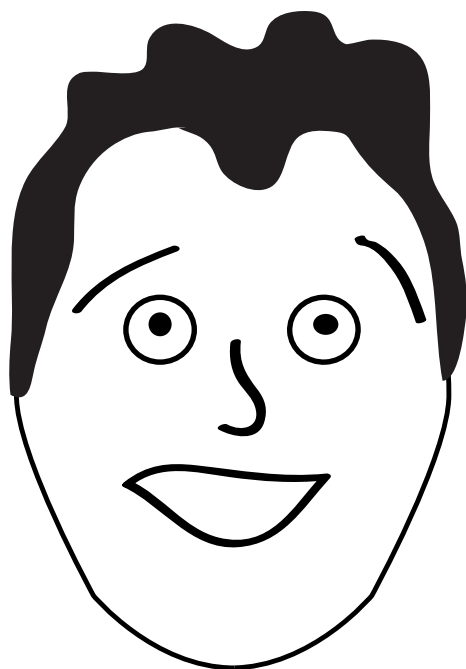

A LPHABET ALLITERATION

Alliteration is when 2 or more words start with the same letter—ALLITERATIONS ARE AWESOME!

Invent an alliteration for each letter of the alphabet. Then draw each letter to show off your alliteration. *Hint:* it's okay if not every single letter of your alliteration starts with the same letter.

A

An Army of Ants

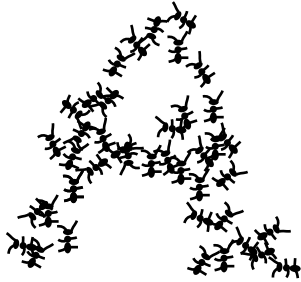

E

B

F

C

G

D

H

I

N

J

O

K

P

L

Q

M

R

S

X

T

Y

U

Z

V

W

GETTING AROUND: Use these exercises to learn to draw.

Sailboat

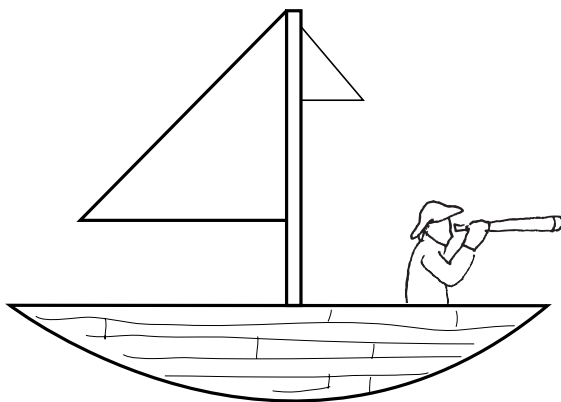
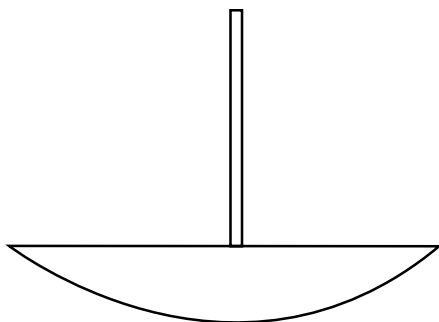
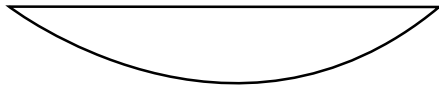

Train

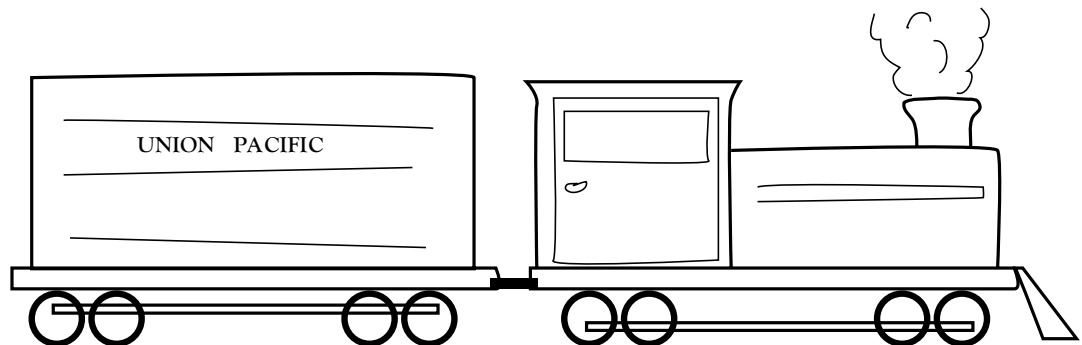
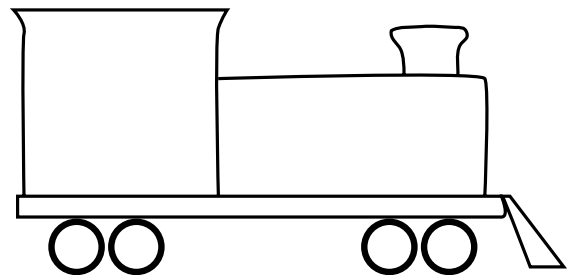
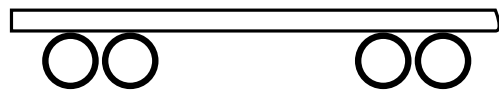

Airplane

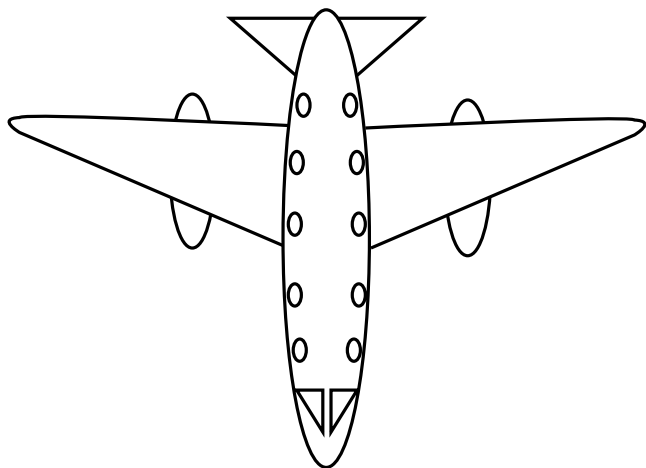
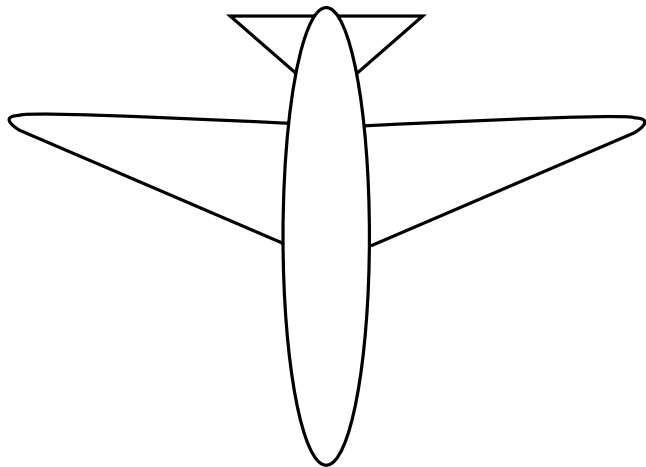
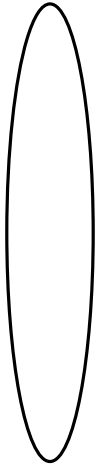

Bus

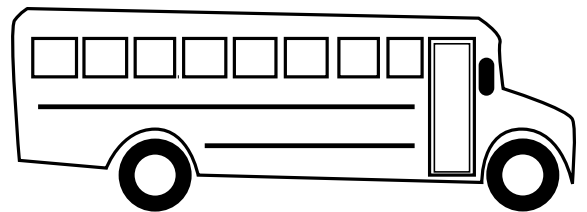
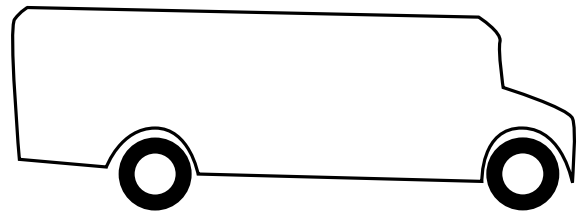

Draw the sailboat, train, airplane and bus near the places they go.

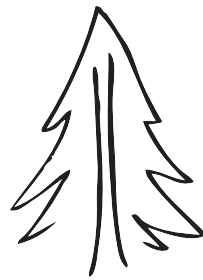
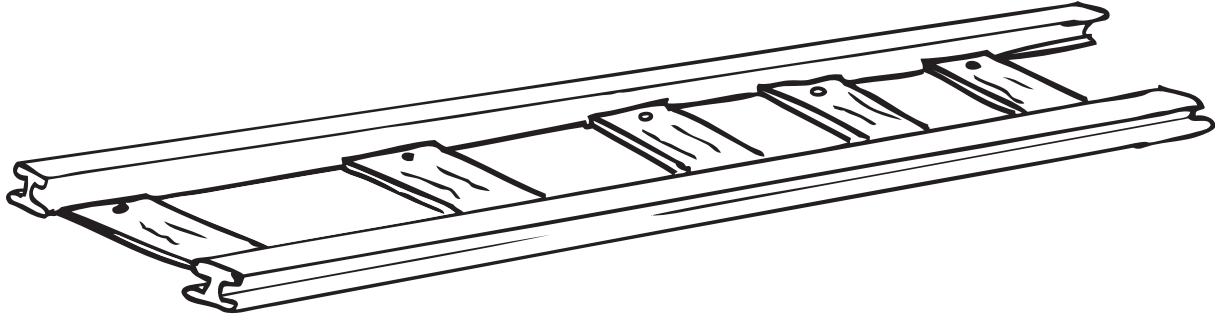
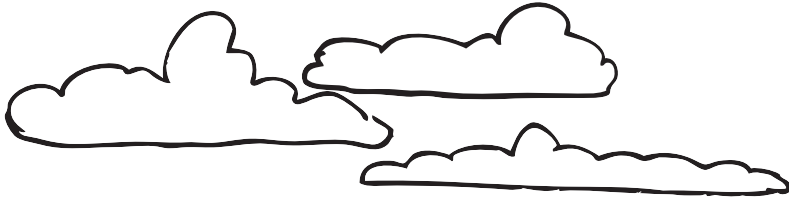

COUNTING: Draw a picture to represent each number!

What comes in one?
Lots of things come in one. For example, one hat or one tail. Draw a picture to show one!

1

One Hat

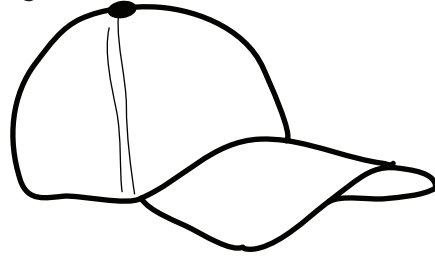

What comes in two?
Lots of things come in pairs. A pair of shoes, a pair of twins... Draw a picture to show two!

2

3

4

5

6

7

8

9

0

POINTILLISM

Pointillism is a way of painting that painters came up with in the 1800s. They used tiny dots of color instead of brush strokes. When small dots of different colors are next to each other the eye blends them together when they are looked at from a distance. Paint a square of one color and then add small dots of a different color on top of it to make different shades.

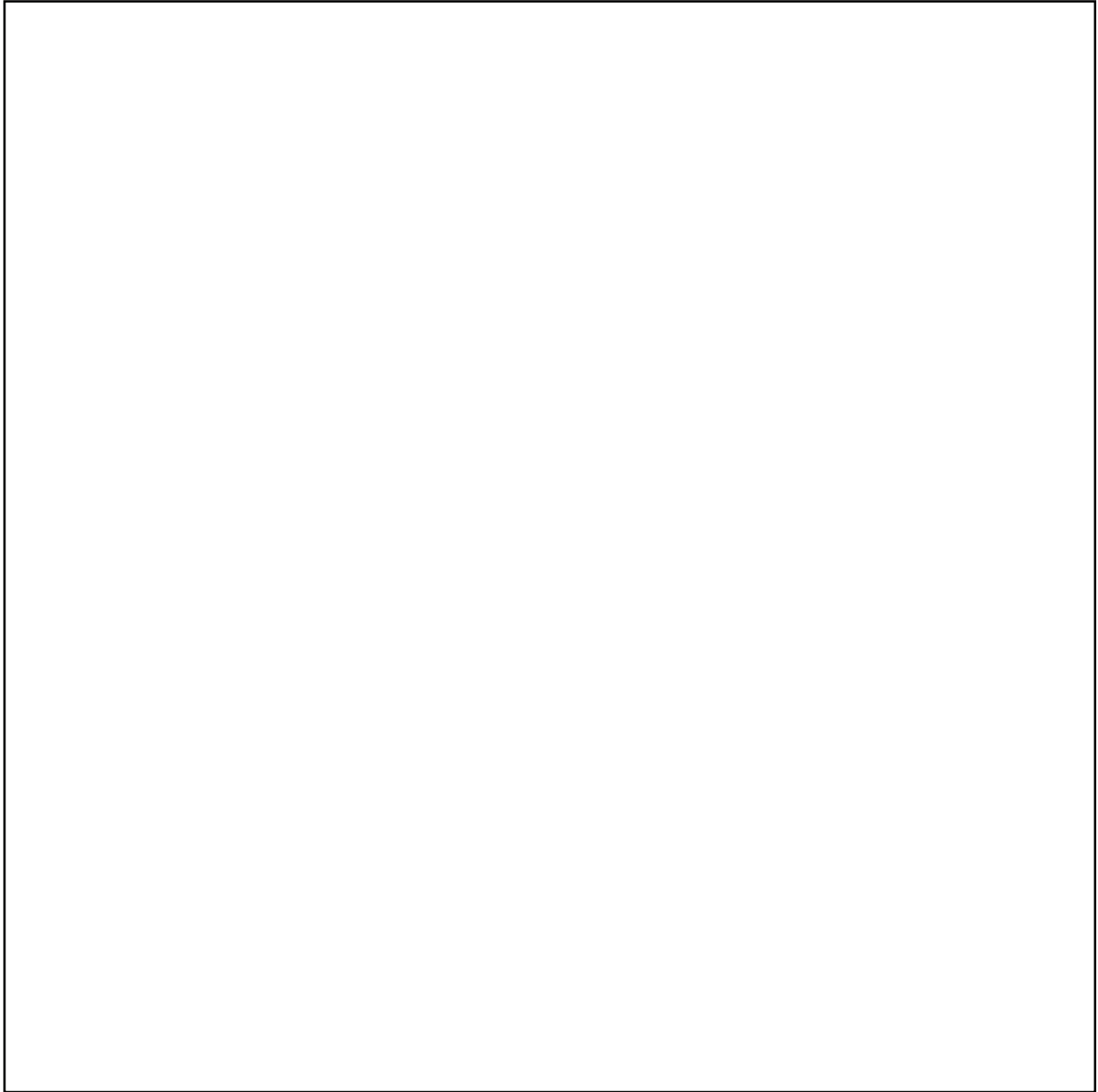

POINTILLISM

The painting below is called *La Grande Jatte*. It was painted by a French painter named George Seurat in the 1800s. It was one of the first paintings to use pointillism. Try coloring in the lady from the painting in the same style. See if you can add some background colors too!

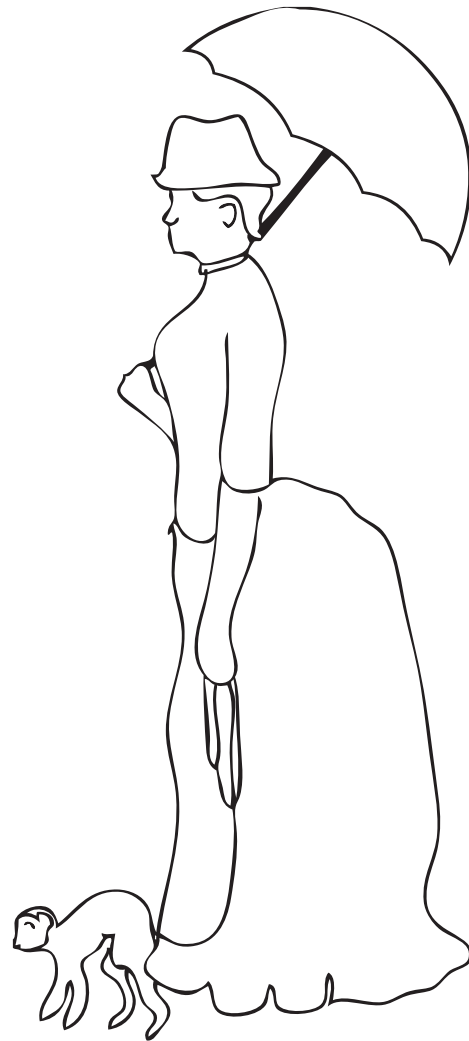
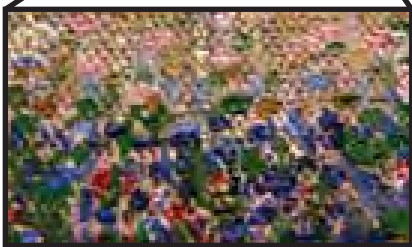

COLORS: Learn how colors work

All the colors of the rainbow together are called a spectrum.
There are three primary colors that can mix to make other colors!
Can you name the three primary colors?



Create your own color spectrum!

When all of the colors mix together, they create white!

Try cutting out this color wheel, or color in your own below. Poke a pencil through the center, and spin the wheel. What happens?

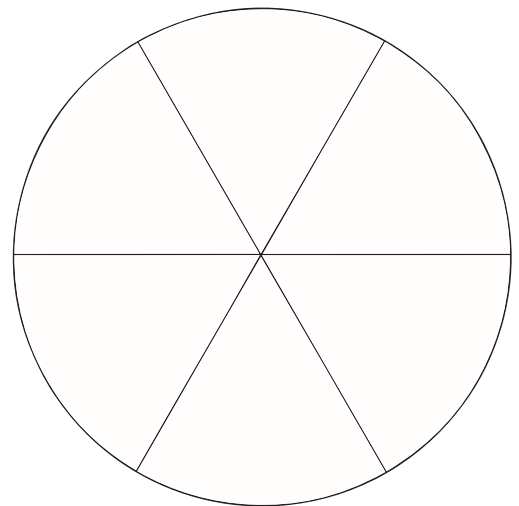
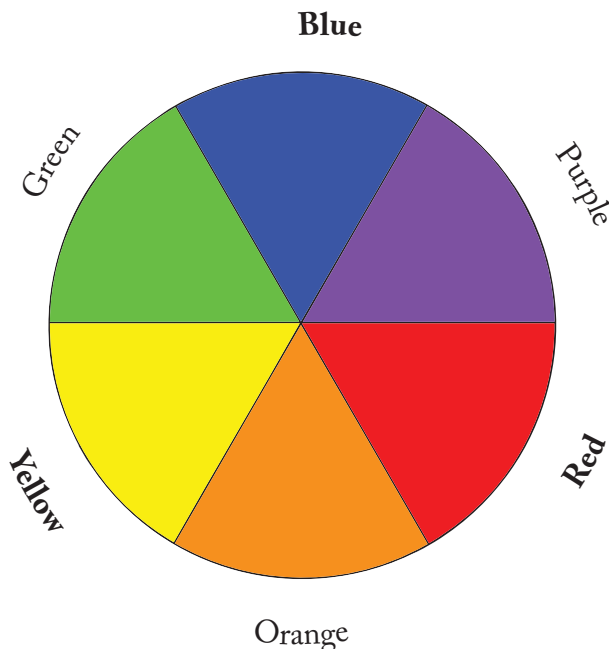

COLORS: Mixing Colors

Complementary Colors: These are two colors that are directly across from each other on the color wheel. When they are mixed they make grays and browns.

Purple & Yellow



Green & Red



Orange & Blue



There is no limit to how many different colors there are.

Blue & White



Red & Yellow



M

AKING NEW COLORS

Mix paints to create new colors for the drawings.

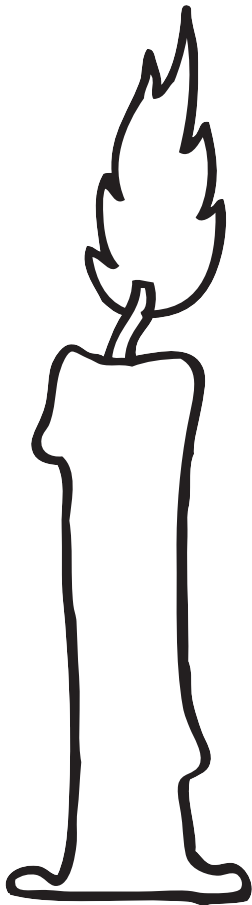
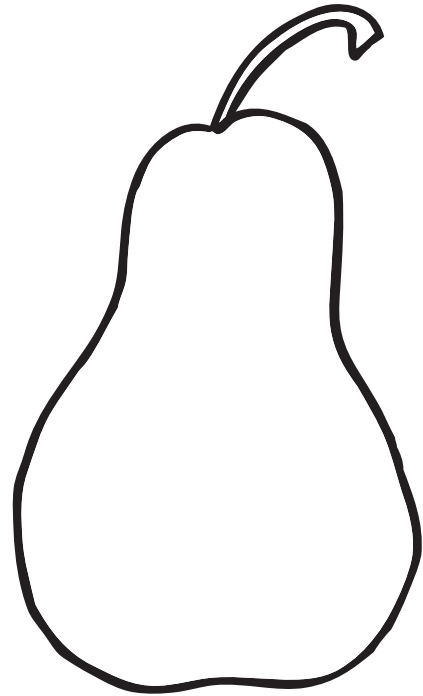

3 DIMENSIONAL SHAPES

A Cylinder

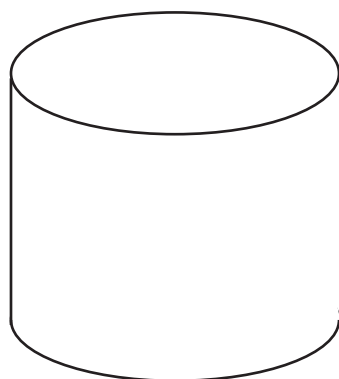
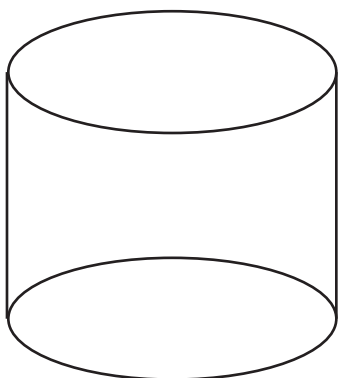
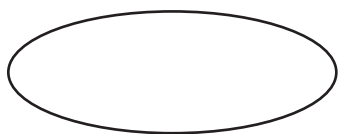
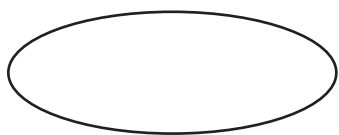

A Cube

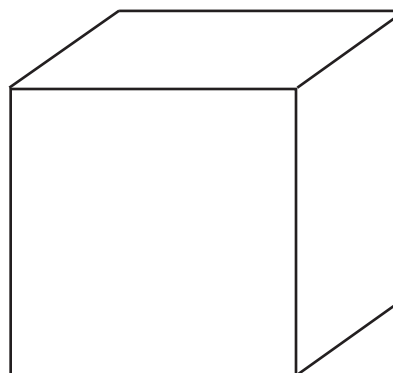
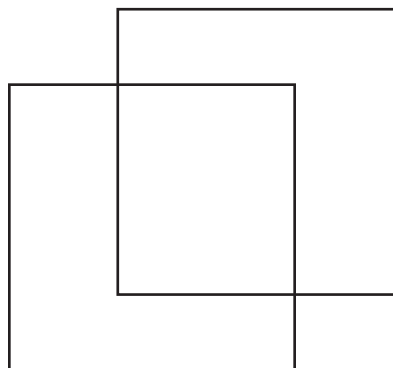

A Cone

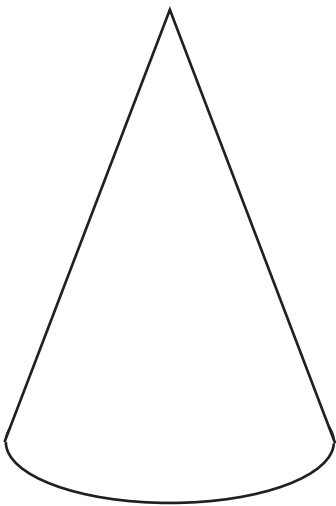
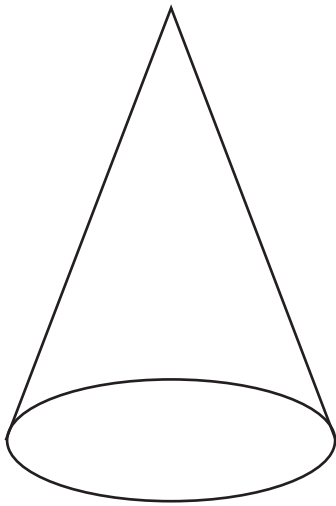
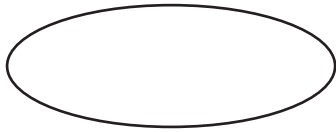

A Pyramid

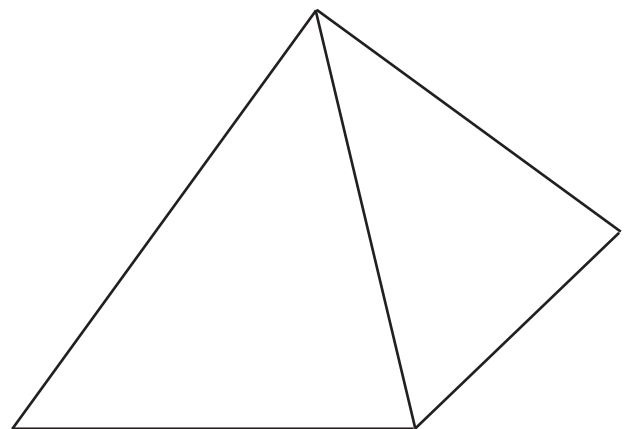
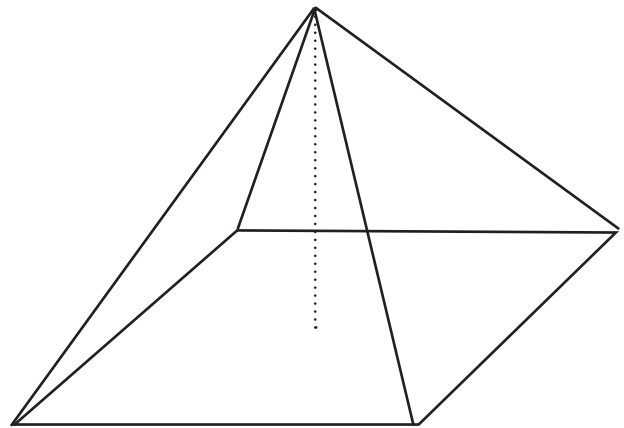
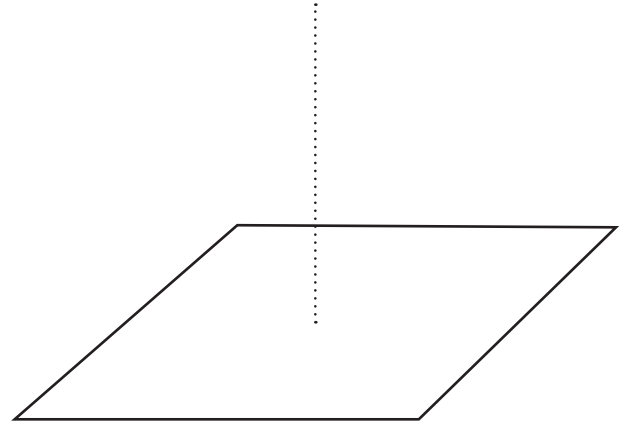

SYMMETRY

Symmetry is when both sides of something are the same.

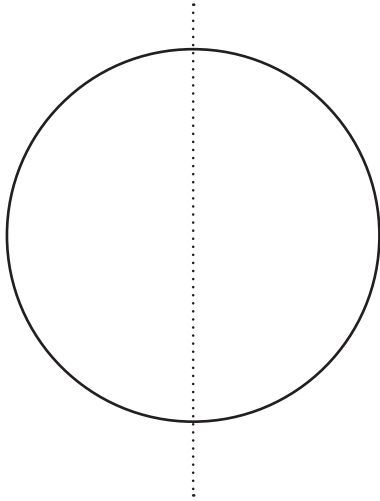

A circle is symmetrical.

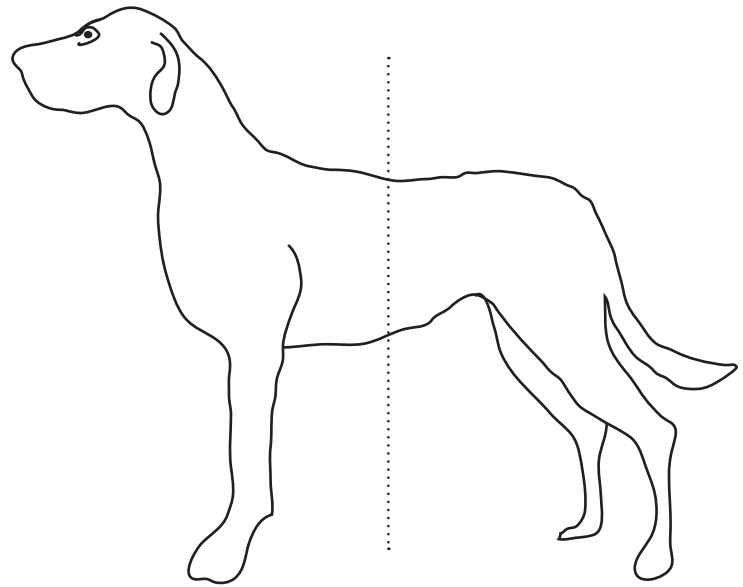

A dog is not.

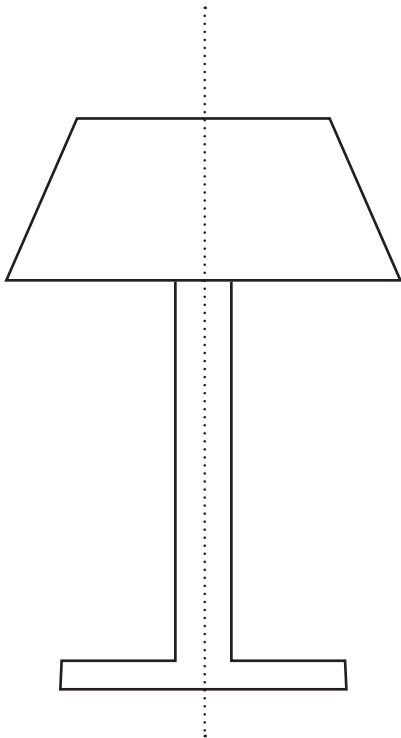

Is this lamp symmetrical?

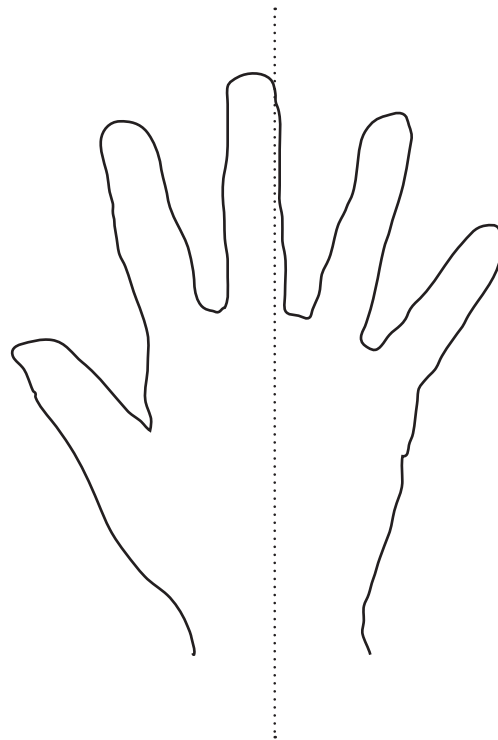

Is this hand symmetrical?

Finish these drawings so that they are symmetrical.

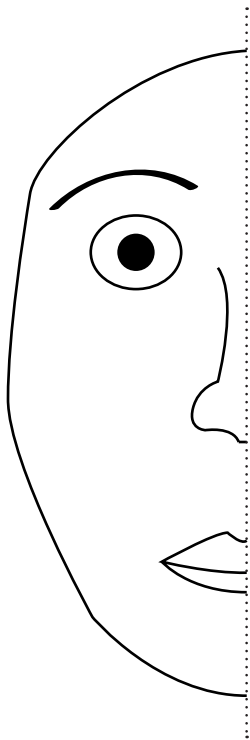
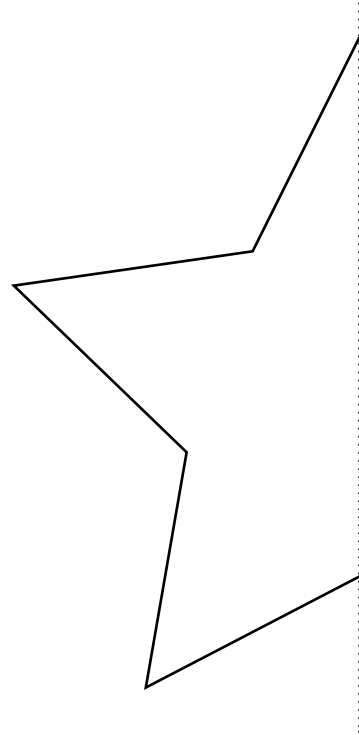
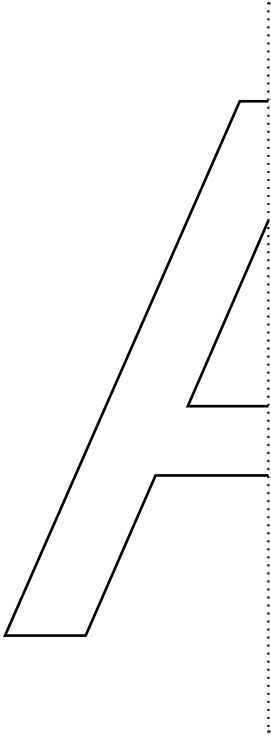

RULERS RULE

Rulers are good for drawing straight lines and measuring things. Lots of fun things can be done with rulers.

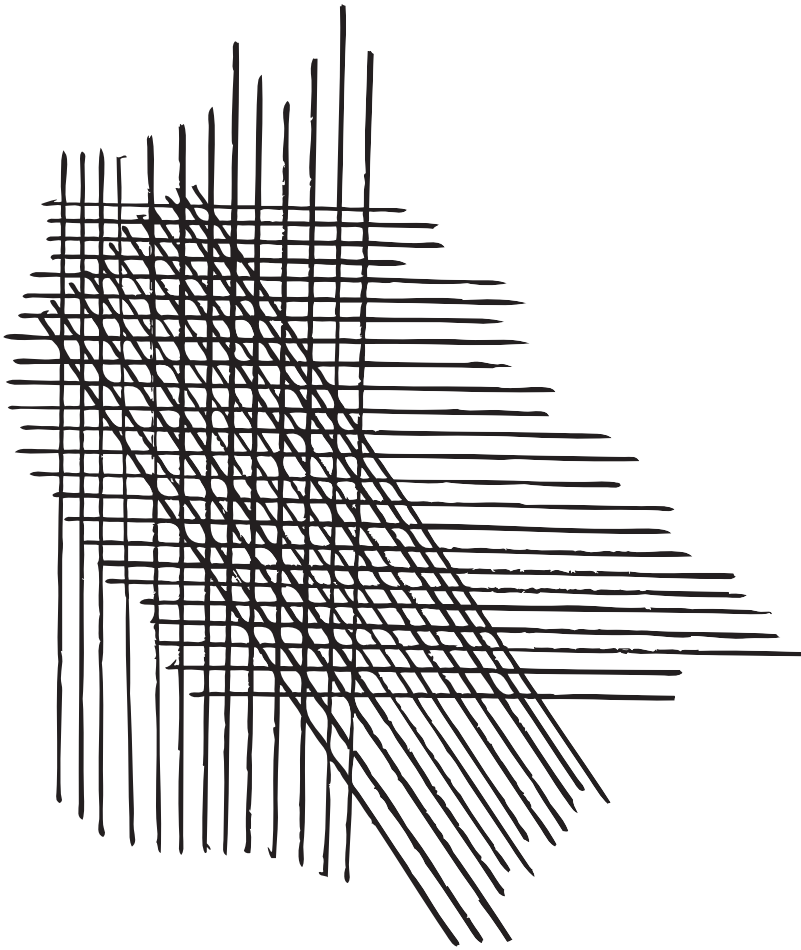

Try drawing different patterns with straight lines, using a ruler.

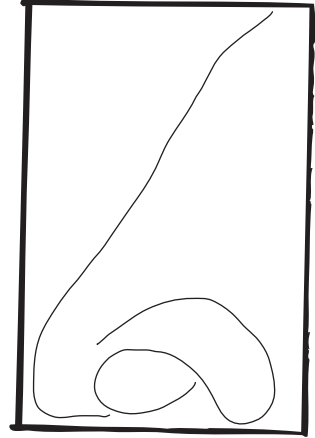

This is a rectangle with the same width and height as my nose.

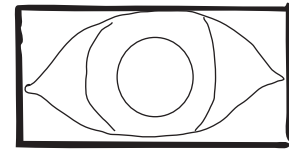

This is a rectangle with the same width and height as my eye.

Try drawing rectangles using the measurements of your fingers and hands.

DRAWING A TREE

All plants have patterns to how they grow. A tree does too and it is a simple one. The rule is every new branch is thinner than the one it came from.

The branches from this tree always split into two smaller branches. We can draw it using the letter Y.

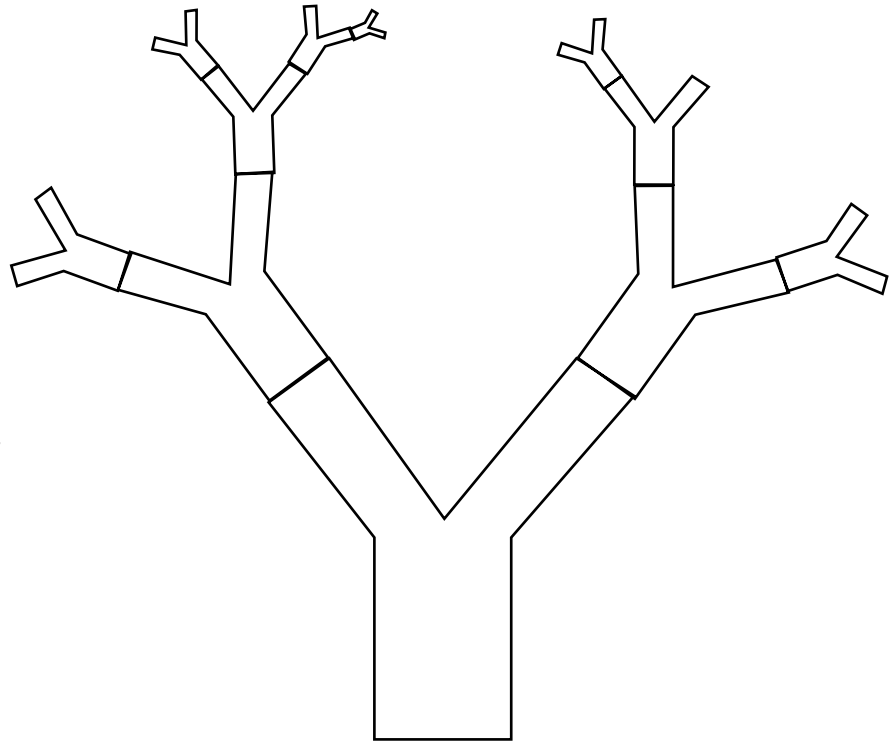
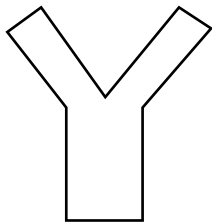

Try drawing a tree from your imagination using this rule.

DRAWING A TREE

Real trees always look different from the one we drew before, but they keep the same rule. The bigger branch always splits into thinner ones.

This is a tree that has had some branches chopped off.



Go outside and find a tree to draw. Does the tree follow the rule?

Great job!

is an Education.com reading superstar

