

READING II

for Information: U.S. Cities

3RD
Grade



Table of Contents

Reading for Information: U.S. Cities II

History of New York City
History of Pittsburgh
History of Minneapolis
History of Baltimore
History of St. Louis
History of New Orleans
History of Montgomery
History of Nashville
History of Dallas
History of Austin
History of Phoenix
History of Las Vegas
History of Seattle
History of Los Angeles

Certificate of Completion

Want more workbooks? Join Education.com Plus to save time and money.
<http://www.education.com/education-plus/>

The history of... *New York*



Word Search!

Find the famous landmarks and features listed below.
Words may be upside down, backward or diagonal.

S R N Z Y Z I C Y S N I N
L T L W L N S Z L C O M E
V M O R I C A N R E V E W
I B G C R E A D T N C I A
S N D O K I E O A T B S M
P D I U Z E V X O R M D S
R L R A T M X E A A A T
E F B J I P G C R L T Y E
S Z R X Y D N A H P W N R
L O E B R O A D W A Y L D
E H W X N I I Z N R N T A
Y T O F N O H J O K E G M
L X T I M E S S Q U A R E

New Amsterdam
Broadway
Times Square
Central Park
Stock Exchange

Time Line



Quiz

What island, located in New York Bay, belongs in part to New York City and in part to Jersey City, New Jersey?

Answer: Ellis Island. Located in the Upper Bay, it was the nation's busiest immigration station between 1892 and 1954.

Name that *borough!*

A borough is an area with its own government, usually within a city. New York City is made up of five boroughs. Can you match the name of the borough with its place on the map?

- A. Manhattan
- B. Brooklyn
- C. Queens
- D. Staten Island
- E. Bronx

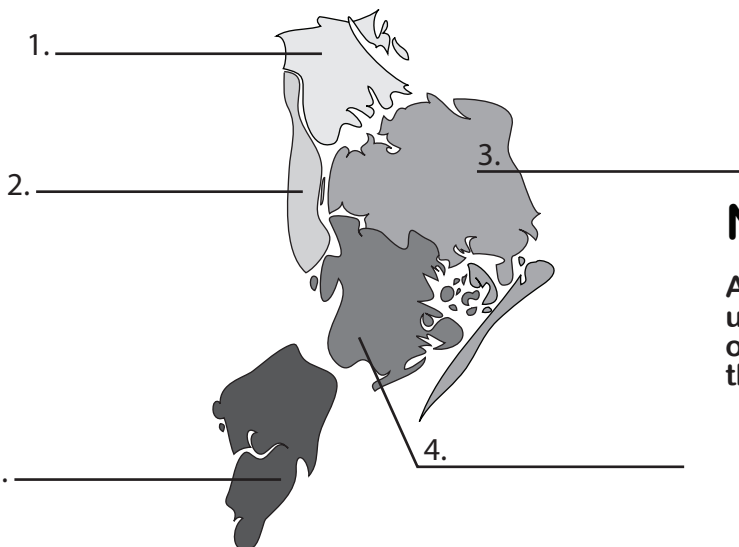

Answers: 1) E 2) A 3) C 4) B 5) D

The history of... *Pittsburgh*



Word Search!

Find the famous landmarks and features listed below.
Words may be upside down, backward or diagonal.

P O N Z Y T I C Y D N I W
R I V I R I R U O S S I M
I C R O D S R A S I E N H
S B X A V E A D T M C I C
H N E O T U E O A A B S E
M D P U Z E B H O U M D S
U L C A T M S I A T A A R
S F H J I P H O O A T B E
E Z R X L R I R A Z A O L
U O P E N G U I N S O T E
M H O X N I F V O N I Z E
R A Z T F E B E I V X L T
C I T Y O F B R I D G E S

Ohio River
City of Bridges
Pirates
Steelers
Penguins

Time Line

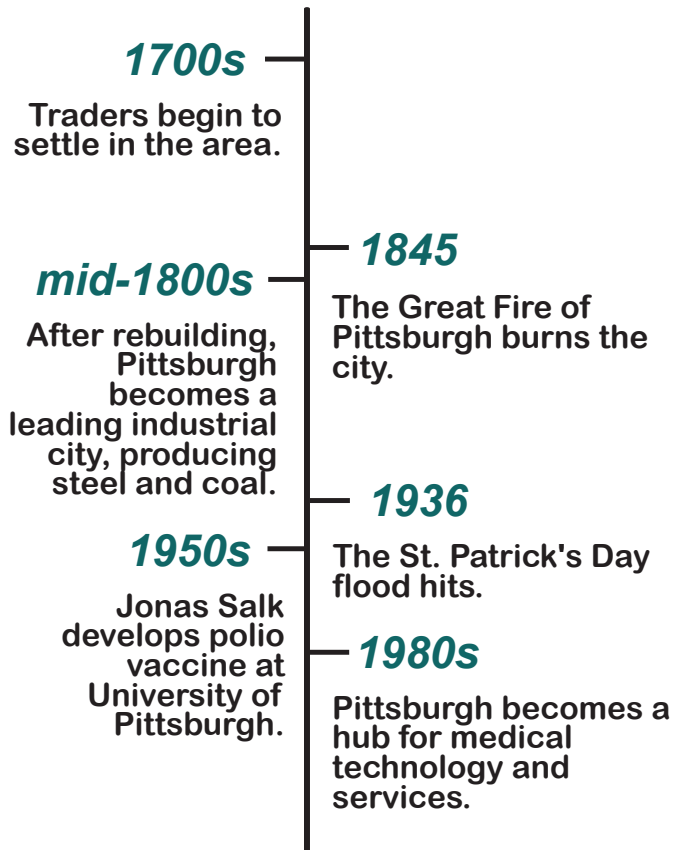

Name that *bridge!*

Pittsburgh has more bridges than any other state in the U.S. Match the bridges below with their names. Then, color them in!

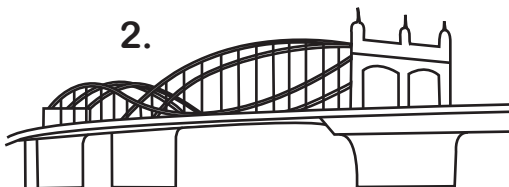

- A. California Avenue Bridge
- B. 10th Street Bridge
- C. Smithfield Street Bridge

Quiz

Pittsburgh lies at the meeting point of the _____ and _____ Rivers.

_____ two rivers.
the confluence, or meeting place, of the
Pittsburgh's central business district lies at
Allegheny and Monongahela.

Answers: 1) B 2) C 3) A

The history of... *Minneapolis*



Word Search!

Find the famous landmarks and features listed below.
Words may be upside down, backward or diagonal.

T W I N S V I C H I L L Y
U I L W L N L Z L N O C P
N E M A D S T A S I E I H
I X T B B A C R I V E T C
O T E O E A I O A A B Y E
N E P U Z R M X O U M O Q
S R C A T M W A A T A F E
T A W H R I V O R W A L K
A V R X L R E L L I A A D
T E D E Y V T F E V V K K
V I K I N G S R E T E E D
O U Z F X O I J O N E S R
N E A U Q N R E E B O I P

City of Lakes
Timberwolves
Twins
Vikings
Lynx

Time Line

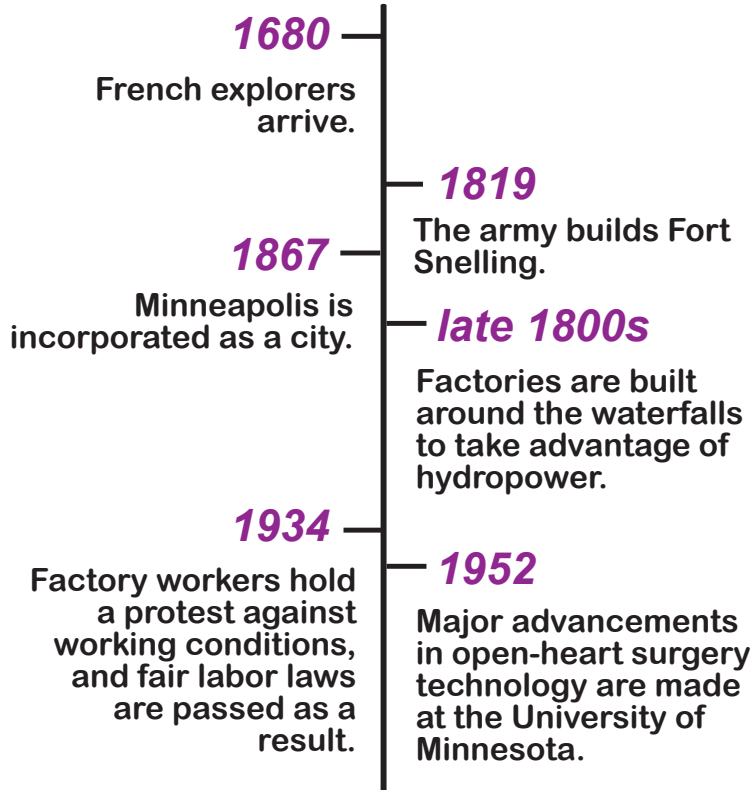

Quiz

The name "Minneapolis" combines words from what two languages?

Answer: Greek and Dakota, a Native American language. It is a combination of Greek *polis*, meaning city, and Dakota *mi*, meaning water.

Solve the *maze!*

The Minneapolis park system is one of the best in the U.S. Can you find your way from one end of the Chain of Lakes to the other? Don't fall in the lake!

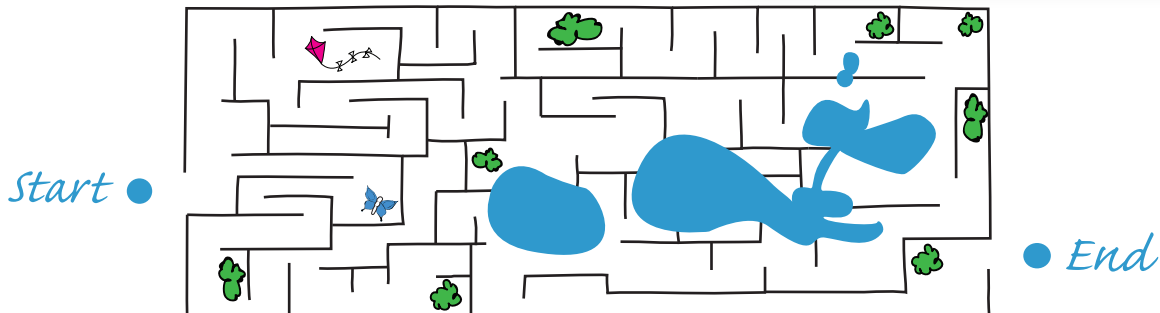

The history of... *Baltimore*

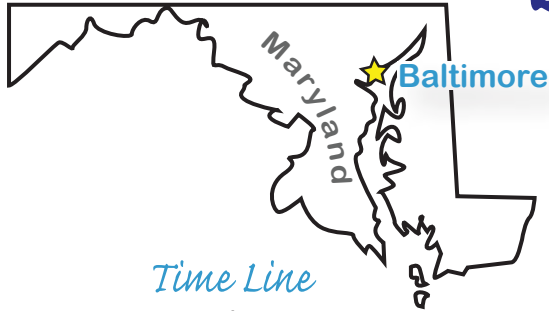

Word Search!

Find the famous landmarks and people listed below.
Words may be upside down, backward or diagonal.

F	O	F	D	C	Z	O	O	O	A	O	H
O	Q	L	W	L	N	L	Z	L	N	K	T
R	P	R	E	U	V	C	T	E	G	G	U
T	B	X	S	V	E	H	D	R	E	C	R
M	N	E	U	P	U	I	M	A	L	B	E
C	D	R	O	G	Q	U	G	A	I	G	B
H	L	C	H	T	I	A	Z	A	S	A	A
E	F	H	G	R	P	T	K	O	L	T	B
N	L	E	A	T	E	O	P	T	A	A	T
R	B	U	L	V	P	W	E	P	N	B	I
Y	Q	U	F	D	A	N	A	T	D	A	O
A	O	R	I	O	L	E	P	A	R	K	C

Oriole Park
Aquarium
Fort McHenry
Flag House
Babe Ruth

Time Line

- 1706** — The Port of Baltimore is opened.
- 1729** — Baltimore is founded.
- 1776** — For a few months during the American Revolution, the nation's capital is moved to Baltimore.
- 1814** — The Battle at Fort McHenry inspires Francis Scott Key to write "The Star-Spangled Banner".
- 1904** — The Great Baltimore Fire destroys 70 blocks of the city.
- 1968** — Riots break out in Baltimore after the assassination of Dr. Martin Luther King, Jr.

Quiz

What kind of craft was successfully launched in Baltimore for the first time in U.S. history?

Answer: An air balloon

Spot the Differences!

The Preakness Stakes is a thoroughbred horse race run each year in May. Can you find 5 differences between these race horses?

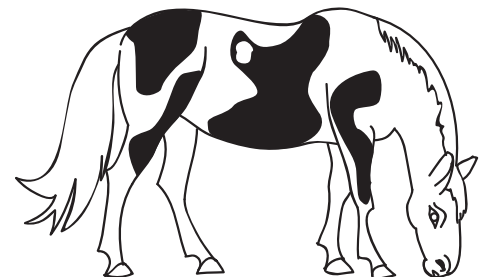
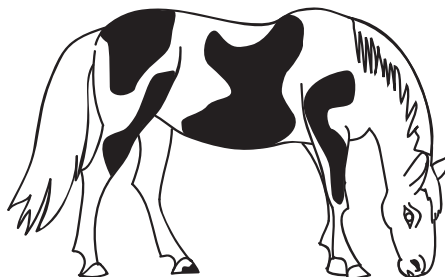

Answers: 1) Mane on #2 is shorter. 2) Tail on #2 is moving. 3) Spot on hoof of #1. 4) Front legs on #1 are closer together. 5) Extra spot on #2.

The history of... *St. Louis*



Word Search!

Find the St. Louis landmarks and features listed below. Words may be forward, backward, diagonal, or even upside down!

H O F D C Z O U O A O G
 G E T T Y M U N E U M A
 N P R S U V C I D G G T
 S M A R S I U O L T S E
 H O Z D Y W G N D L B W
 B D R A G T D S A I G A
 X L C X O R G T A S A Y
 T F H W L P E A L L T A
 E L N S T E R T I A A R
 P B I S L A N I D R A C
 A O U A D A N O A D A H
 Y V E N I C E N E A C H

Gateway Arch
 Union Station
 Dogtown
 Cardinals
 St. Louis Rams

Quiz

The St. Louis area is home to a park, animal farm, and historical site named for what U.S. President?

Answer: Ulysses S. Grant

Time Line

1764

Pierre LaCledé and his partner Auguste Chouteau establish a settlement on the banks of the Mississippi River.

1803

The U.S. acquires St. Louis as part of the Louisiana Purchase.

1804

The Lewis and Clark Expedition leaves St. Louis.

1846

The *Scott v. Emerson* case takes place in the Old Courthouse.

1904

St. Louis hosts the Louisiana Purchase Exposition and the Summer Olympics.

1967

The Gateway Arch is opened.



Spot the *differences!*

On the Tree Walk at Forest Park, you can see 90 different types of trees! Find five differences between these trees. You can even color them in!

Answers: 1) Bird furthest to right is different 2) Top right leaves are different 3) Extra limb on second tree 4) Extra shrub beside first tree 5) Leaf falling from tree

The history of... *New Orleans*

Time Line



late 1600s

French explorers and traders arrive.

1763

New Orleans comes under Spanish rule as a result of the Seven Years' War.

1718

New Orleans is founded by the French.

1800

Spain gives Louisiana back to France.

1803

The U.S. acquires the Louisiana Territory from France.

1897

Free man Homer Plessy is arrested for refusing to ride in the segregated car on a train passing through New Orleans.

2005

Hurricane Katrina, the largest and most destructive storm to hit the city, hits land.

Word Search!

Find the New Orleans landmarks and features listed below. Words may be forward, backward, diagonal, or even upside down!

F	O	F	D	C	Z	O	O	A	O	O	F	
C	R	L	W	L	N	L	Z	L	N	K	M	G
A	P	E	S	U	V	C	T	E	G	G	D	N
N	B	X	N	V	E	H	D	R	M	C	R	A
A	N	E	O	C	U	I	V	A	A	B	E	Y
L	D	R	A	G	H	N	G	A	R	G	W	A
S	L	C	A	T	R	Q	Z	A	D	A	O	L
T	F	H	J	L	P	T	U	O	I	T	T	A
R	L	R	Z	S	B	A	N	A	G	A	T	B
E	B	I	O	V	P	W	E	P	R	B	I	M
E	O	U	A	D	A	N	A	T	A	T	O	A
T	T	R	G	E	G	W	G	Q	S	N	E	J
J	A	Z	Z	M	U	S	I	C	A	O	O	R

French Quarter
Jambalaya
Jazz Music
Canal Street
Mardi Gras

Quiz

What did the French originally name New Orleans, and what did the name mean?

Answer: La Nouvelle-Orléans, meaning "The New Orleans." It was called "new" because France already had a city by that name.

Give yourself

Mardi Gras beads!

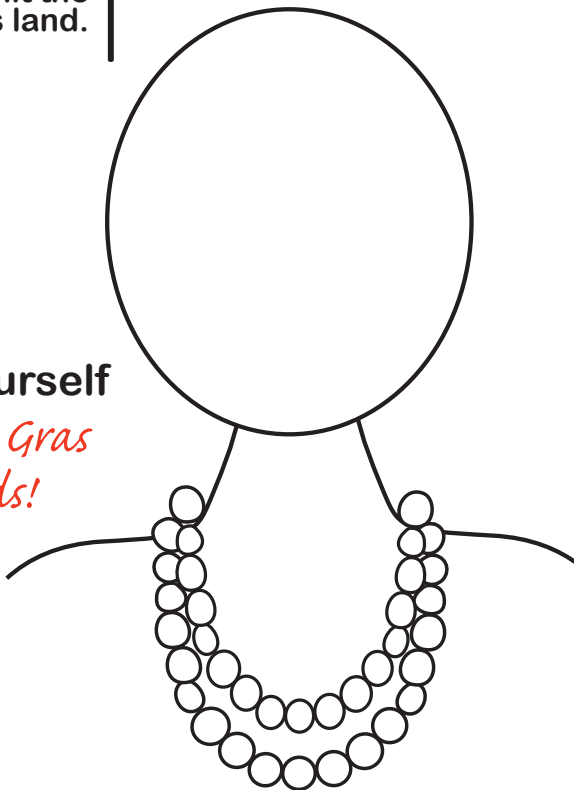

Mardi Gras is an annual celebration that falls on "Fat Tuesday," a part of the holiday of Lent. Colorful beads of all shapes and sizes are a fun part of the Mardi Gras celebration. Draw your portrait in the space provided, then color the beads and draw some of your own--as many as you like!

The history of... *Montgomery*



Word Search!

Find the famous landmarks and features listed below.
Words may be upside down, backward or diagonal.

R A W L I V I C H I L L Y
 U D L W L N L Z L N O I P
 N E A A D S T A S I E A H
 I X T G B A C R I V E R C
 O T E O A A I O A A B O E
 N E P U Z Q M X O U M R Q
 S R C A T M A A A T A T E
 T A W H R I V E R W A L K
 A V R X L R E L I I A M D
 T E D E I V T F E N V L K
 I N N N E D Y R E T X E D
 O U Z F N O I J O N E R R
 N E A U Q N R E E B O I P

Alabama River
Union Station
Riverwalk
Dexter Avenue
Civil War

Time Line

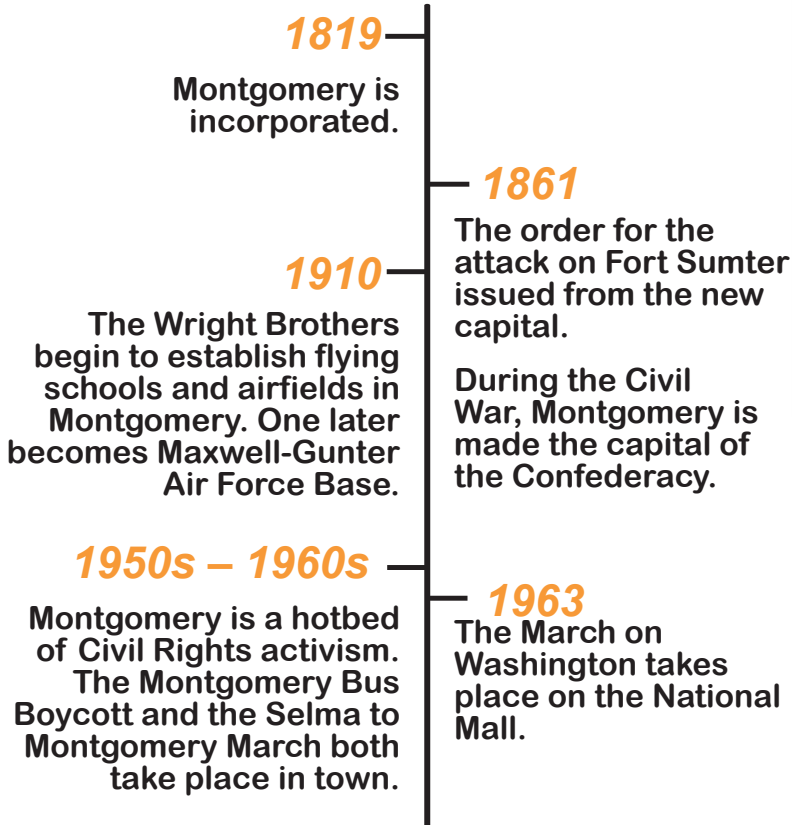

Quiz

Montgomery was the first U.S. city to have a city-wide _____ system.

Answer: Electric streetcars. It replaced a system of horse-drawn streetcars.

Guide the *Montgomery marchers!*

The Selma to Montgomery Marches helped make it illegal to block African-Americans from registering to vote. Can you guide these demonstrators on their way? Help them find a path from the city of Selma to Montgomery.



Selma ○

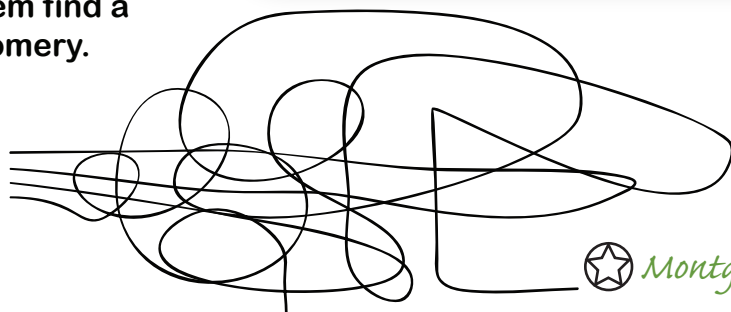

○★ *Montgomery*

The history of...

Nashville



Word Search!

Find the famous landmarks and features listed below.
Words may be upside down, backward or diagonal.

R A D N O R L A K E O F C
X I L W C N O Z G N O R O
A O M S I C N A R O G A U
H S Z N S N C B A X F N N
A N E N U C I S N A S C T
L D P U T E N S D U O I R
S L C A T R B Z O D K S Y
T F H J I P O D L I C N M
C Z R X L R W M E S I A U
E B M O V P L E O I H S S
S R E G N A R S P S D H I
A T Z F N T I J R C I A C
M U S I C C I T Y N O P T

Time Line

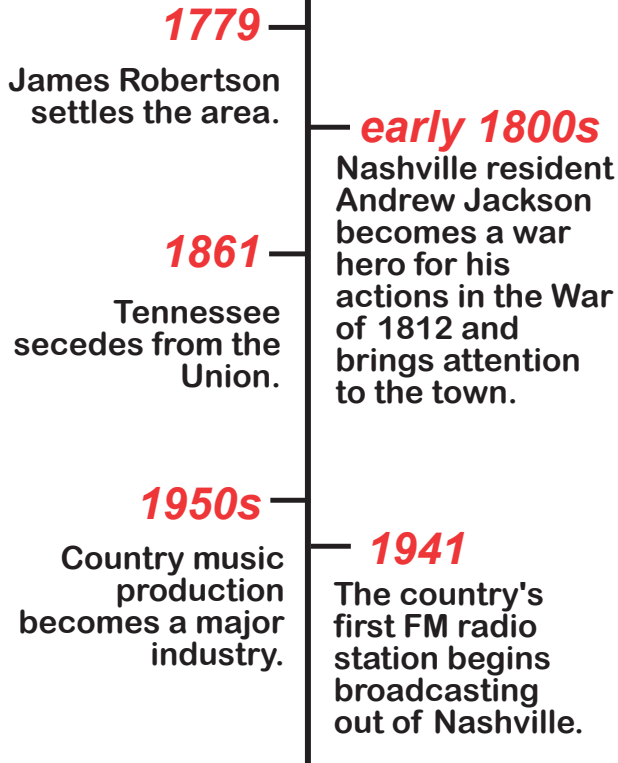

Music City
Radnor Lake
Grand Ole Opry
Francis Nash
Country Music

Name that *instrument!*

Nashville is known for country music, which uses many of its own unique instruments. Match the instruments below with their names. Then, color them in!

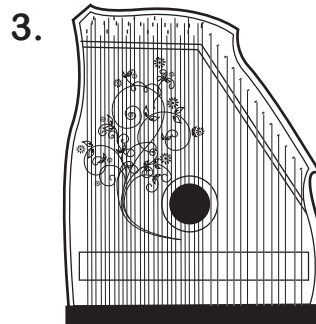
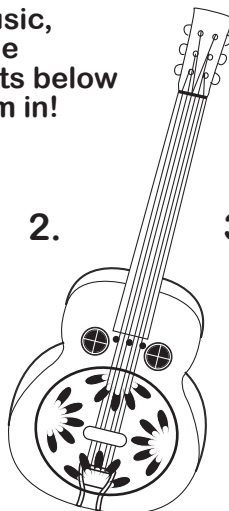
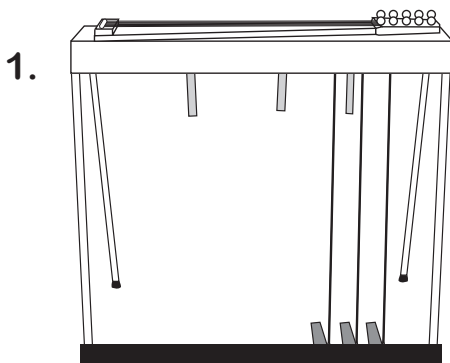

- A. Dobro
- B. Zither
- C. Pedal Steel Guitar

Quiz

A copy of the ancient Greek structure, the _____, stands in Nashville's Centennial Park.

Answer: Parthenon. The original Parthenon was completed in Athens, Greece in 438 B.C.

Answers: 1) C 2) A 3) B

The history of... *Dallas*



Word Search!

Find the famous landmarks and features listed below.
Words may be upside down, backward or diagonal.

D A L L A S C O W B O Y S
C I L W L N O Z H N O M R
A P M S U V T T I R G B E
N B X I V E T D T M C I V
A N E O H U O O E A B S I
L D P U E E N S R U G D R
S L C A T M B Z O D A A Y
T F H J I P O D C I T Y T
C Z R X L R W L K S A N I
E B M O V P L E L I B E N
S R E G N A R S A X E T I
A T Z F N T I J K C E A R
S V E D N A R E E N O I T

Time Line

- 1841** — A settler named John Neely Bryan founds a settlement on the Trinity River.
- 1861** — Dallas votes to secede during the Civil War.
- 1930** — Oil is struck near Dallas.
- 1990s** — Dallas becomes a center for the tech industry.
- 2005** — Hurricane Katrina evacuees take shelter in Houston's AstroDome.

Dallas Cowboys
Cotton Bowl
White Rock Lake
Trinity River
Texas Rangers

Quiz

Dallas/Fort Worth International Airport is the nation's _____ airport.

_____ largest. It contains so many terminals, businesses, and buildings, it is sometimes called an "Airport City!"

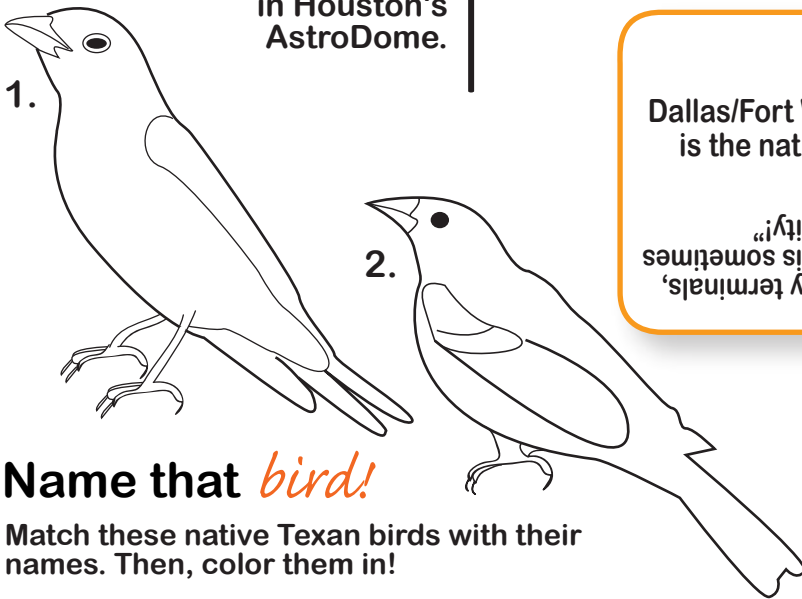

Name that *bird!*

Match these native Texan birds with their names. Then, color them in!

- A. Red Wing Blackbird
- B. Scarlet Tanager
- C. Northern Mockingbird

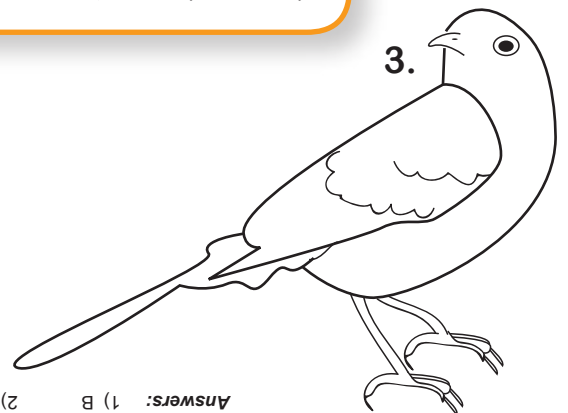

Answers: 1) B 2) A 3) C

The history of... *Austin*



Time Line

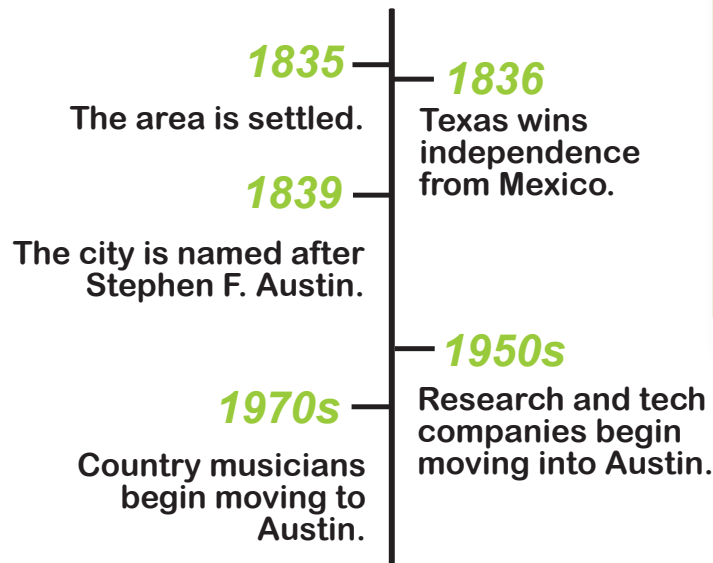

Word Search!

Find the famous landmarks and features listed below.
Words may be upside down, backward or diagonal.

C A S L B R C O N M O P E
 C O L W L N O Z H N O M K
 A P L S U V Z T I R G B A
 N V I O L E T C R O W N L
 A N E O R U O O E A B S D
 L D P U E A N S R U G D R
 S L C A T M D Z O D A A I
 T F H J I P O O C I T Y B
 Z I L K E R P A R K A N Y
 E B M O V P L E L I B E D
 S R E G N A R S A X V T A
 A T Z F N T I J K C E E L
 M O U N T B O N N E L L R

Colorado River
 Violet Crown
 Zilker Park
 Lady Bird Lake
 Mount Bonnell

Make your own art!

Full of museums and galleries, Austin is known to artists throughout the U.S. Do you like to draw? Use your imagination to complete these pictures.

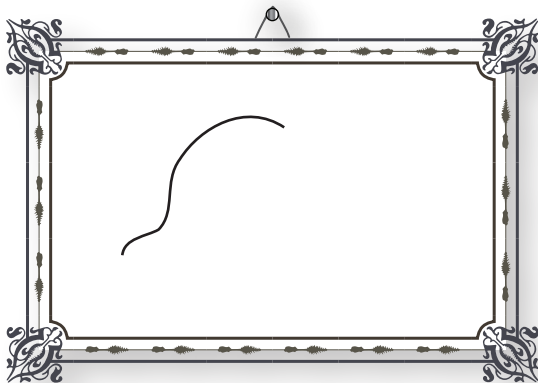

Is it a snake? An ice cream cone?
 Maybe it's a volcano! Turn this line
 into whatever object you like.

Quiz

Stephen Fuller Austin, the founder of the city of Austin, is sometimes called the _____ of Texas.

Answer: Father. He was the first to succeed in colonizing Texas.

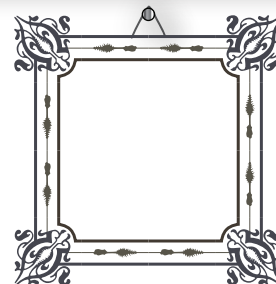

Artists create self-portraits for fun and for practice. Draw your own portrait within this picture frame--or even on the "wall" around it!

The history of... *Phoenix*



Word Search!

Find the famous landmarks and features listed below.
Words may be upside down, backward or diagonal.

S O N O R A N D E S E R T
N I L W L N L Z L N O M P
U N I O N S T A T I O N H
S B X I V E H D T M C I C
X N E O H U I O A A B S E
I D P U Z E T X O U M D Q
N L C A T M N Z A T A A E
E F H J I P T D O A T Y W
O Z R X L R E L R Z A N D
H O L E I N T H E R O C K
P H O E N I X Z O O X B E
A T Z F N O I J O N E A B
E R A U Q N R E E B O I P

Time Line

- 1860s** — explorer Jack Swilling finds ruins of an ancient civilization in the White Tank Mountains and decides to rebuild it. Settlers begin to join him.
- 1881** — Phoenix is incorporated.
- 1906** — work begins on the Roosevelt Dam.
- 1912** — Arizona becomes a state.
- 1930s** — Phoenix becomes a tourist destination known for its exotic desert scenery.

- Sonoran Desert
- Phoenix Suns
- Hole-In-The-Rock
- Phoenix Zoo
- Union Station

Quiz

Unlike most of the country, Phoenix does not observe what seasonal change?

Answer: Daylight Savings' Time, when people temporarily turn their clocks forward so afternoons have more daylight hours.

Spot the differences!

Can you find five differences between the two Sonoran Desert scenes below? You can color the landscapes, too!

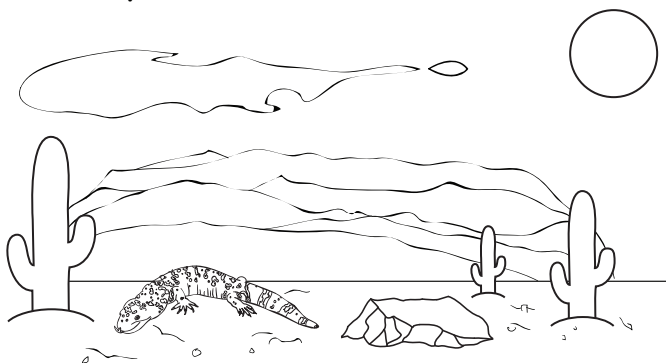

Answers: 1) Cactus in #2 is gone. 2) Extra cloud in sky in #2. 3) Rock in #1 is smaller. 4) Fewer mountains in #2. 5) Fewer spots on gila monster in #2.

The history of...

Las Vegas

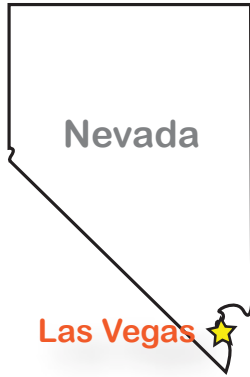

Time Line

- 1844** Explorer John C. Fremont sets up camp at present-day Las Vegas.
- 1858** Silver is discovered in Nevada.
- 1911** Las Vegas becomes an official city.
- 1931** Construction begins on the Hoover Dam. Gambling houses and saloons are built to entertain the workers, and gambling is soon legalized.
- 1950s** Land near Las Vegas is used by the government to test nuclear weapons.

Word Search!

Find the famous landmarks and people listed below. Words may be upside down, backward or diagonal.



- Cactus Garden
- Wax Museum
- Hoover Dam
- Sandstone
- Casino

Quiz

The name "Las Vegas" is a Spanish phrase. What does it mean in English?

Answer: the meadows

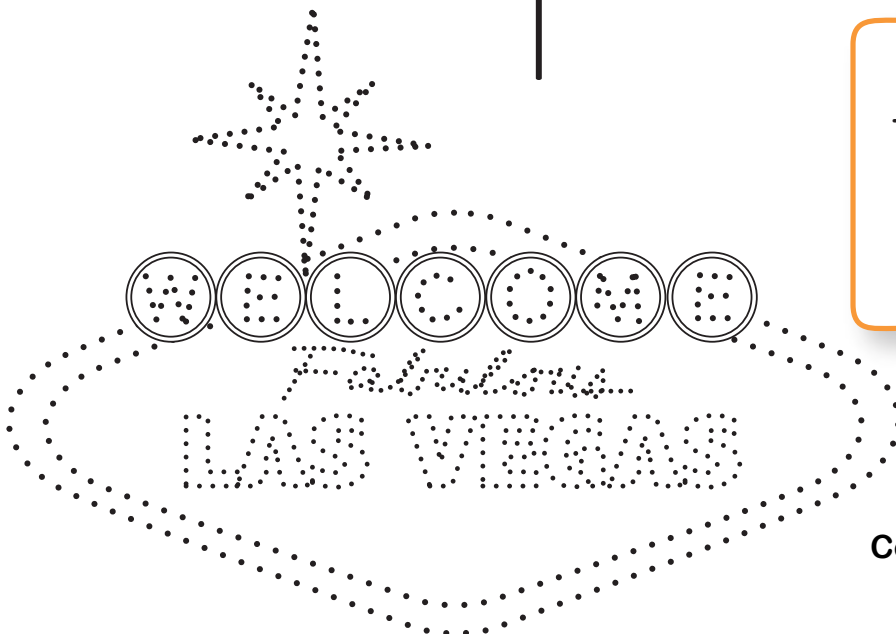

Dot-to-Dot!

Complete the dot-to-dot to draw the famous Las Vegas sign. You can even color it in!

The history of... *Seattle*



Word Search!

Find the famous landmarks and features listed below.
Words may be upside down, backward or diagonal.

J	C	O	F	F	E	E	S	H	O	P	S	S
C	I	L	W	L	N	L	Z	L	N	O	M	P
A	P	M	S	U	V	C	T	E	R	G	B	A
N	B	X	I	V	E	H	D	T	M	C	I	C
A	N	E	O	H	U	I	O	A	A	B	S	E
L	D	P	U	G	E	T	S	O	U	N	D	N
S	L	C	A	T	M	N	Z	A	D	A	A	E
T	F	H	J	I	P	T	D	O	I	T	Y	E
C	Z	R	X	L	R	E	L	R	S	A	N	D
E	B	M	O	V	P	W	E	P	I	B	E	L
E	I	U	A	D	A	N	A	T	A	X	B	E
A	T	Z	F	N	T	I	J	O	C	E	A	N
E	R	A	U	Q	S	R	E	E	N	O	I	P

Time Line

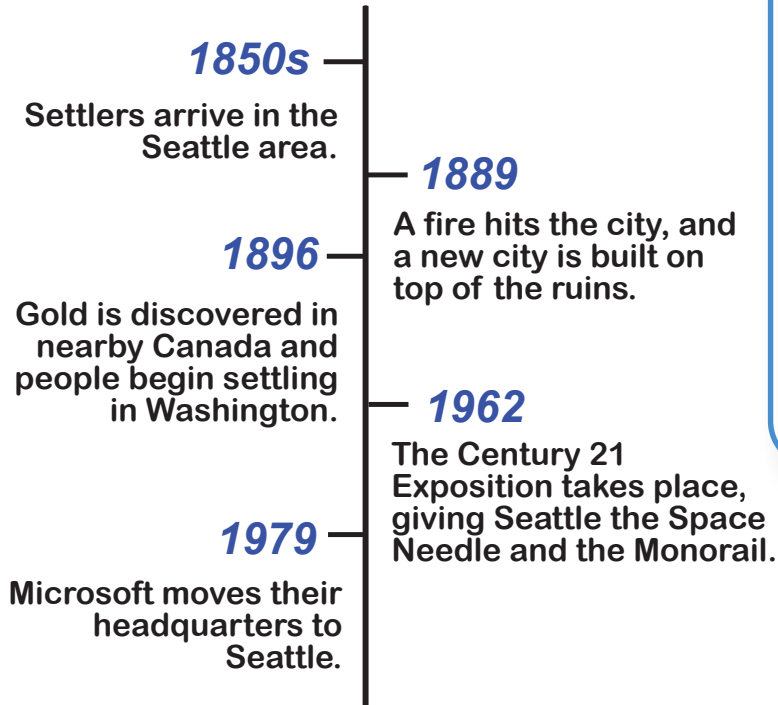

Puget Sound
Jimi Hendrix
Coffee Shops
Pioneer Square
Space Needle

Guide the bicycle through the park!

Seattle's mild climate allows for year-round outdoor activities, and it is a popular city for bicycling. Can you lead this cyclist through the park to the coffee shop? Find the line that leads all the way through the park.

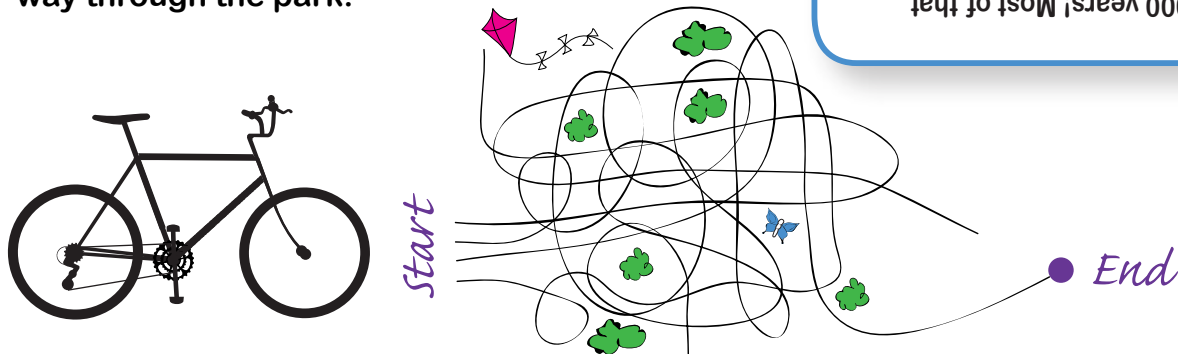

Quiz

How long has Seattle been home to humans?

Over 4,000 years! Most of that time, Native Americans were the main residents. European settlers arrived in the 19th century.

The history of... *Los Angeles*



Time Line

- 1781** — Spanish settlers arrive at El Pueblo de Los Angeles.
- late 1800s** — Los Angeles' citrus industry grows, creating many jobs.
- 1876** — A Central Pacific Railroad stop is established in Los Angeles, linking the city with the rest of the country.
- 1910** — The first film company is established in Los Angeles.
- 1913** — The Los Angeles Aqueduct is completed, bringing water to the city.
- 1932** — Los Angeles hosts the Summer Olympics.

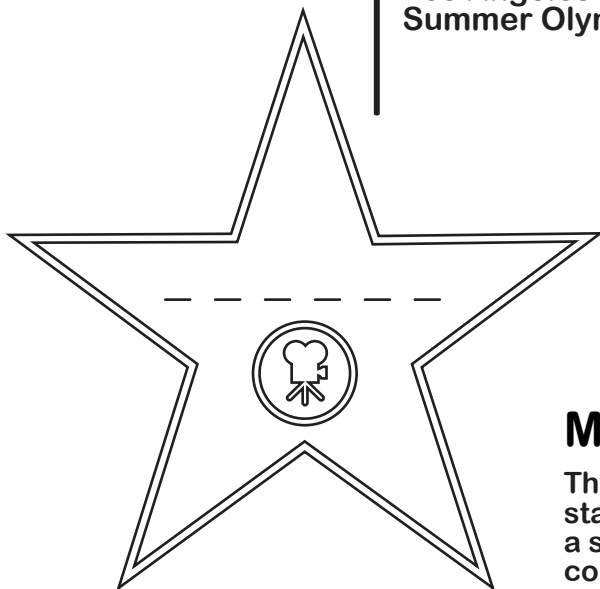

Word Search!

Find the Los Angeles landmarks and features listed below. Words may be forward, backward, diagonal, or even upside down!

H O F D C Z O O O A O O
 G E T T Y M U S E U M M
 N P R S U V C T B G G D
 E B X I V E D D O E C R
 H O L L Y W O O D L B E
 B D R A G Q D G A I G W
 A L C A T R G Z A S A O
 T F H J L P E K L L T T
 E L E S T E R P I A A T
 P B I O V P S E V N B I
 A O U A D A N A A D A O
 Y V E N I C E B E A C H

- Hollywood
- Getty Museum
- Avila Adobe
- Venice Beach
- Dodgers

Quiz

Dodger Stadium sells more of what than any other Major League baseball stadium?

Answer: hot dogs

Make yourself a *star!*

The Hollywood Walk of Fame is filled with shiny pink stars with celebrities' names printed in gold. Want to be a star? Fill in your own name on the dotted line, then color your Walk of Fame star!

Great job!

is an Education.com writing superstar

