

**Craftsman
Revival Chair
Number 1**

Directional Views of Chair

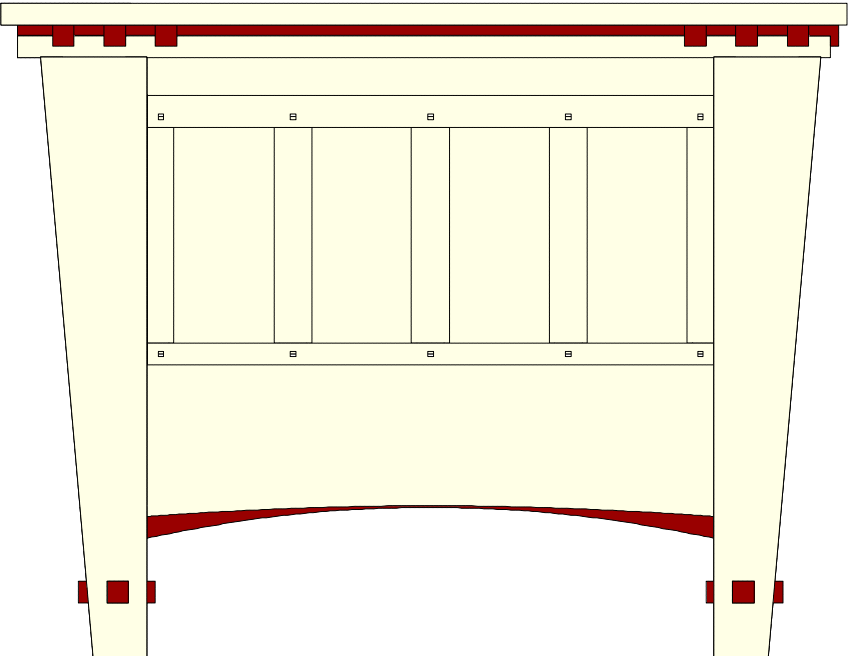

Side View

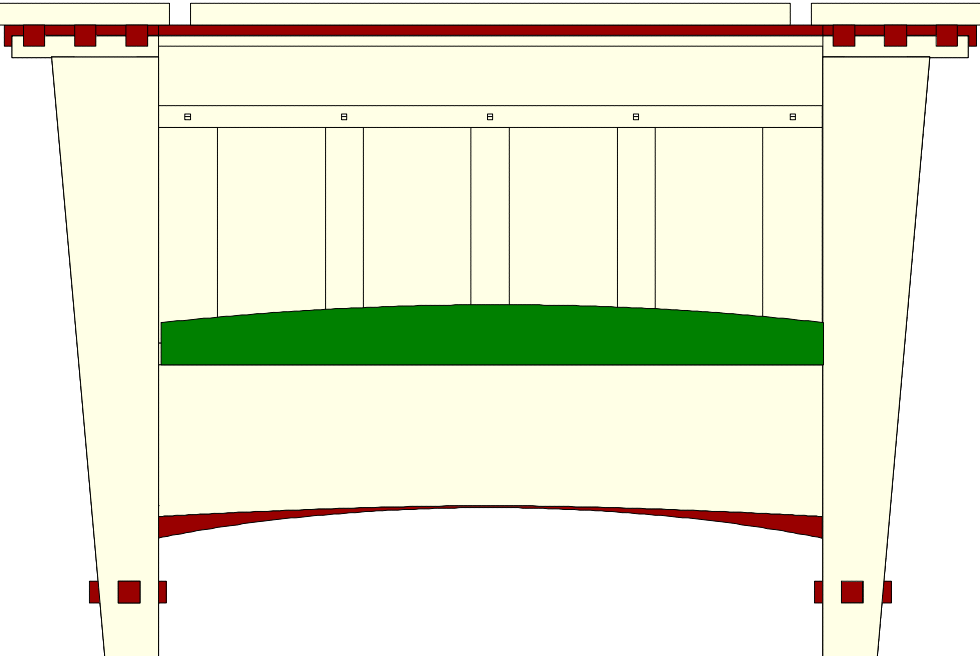

Front View

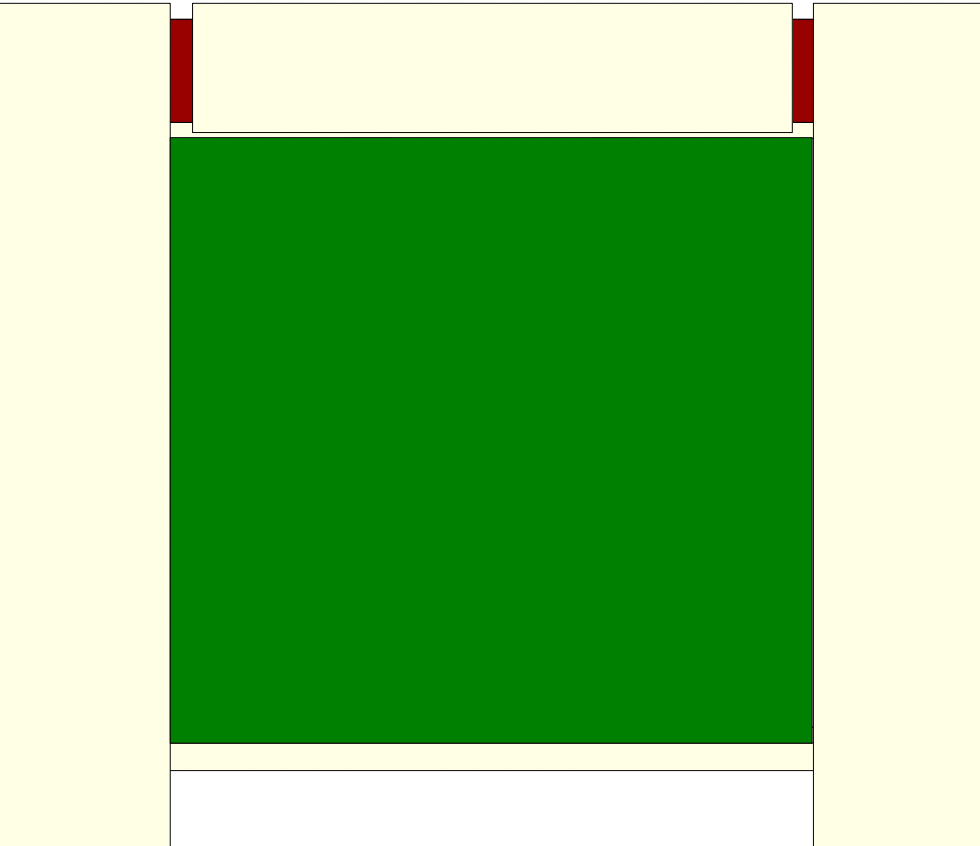

Top View

Exploded View of Chair Back

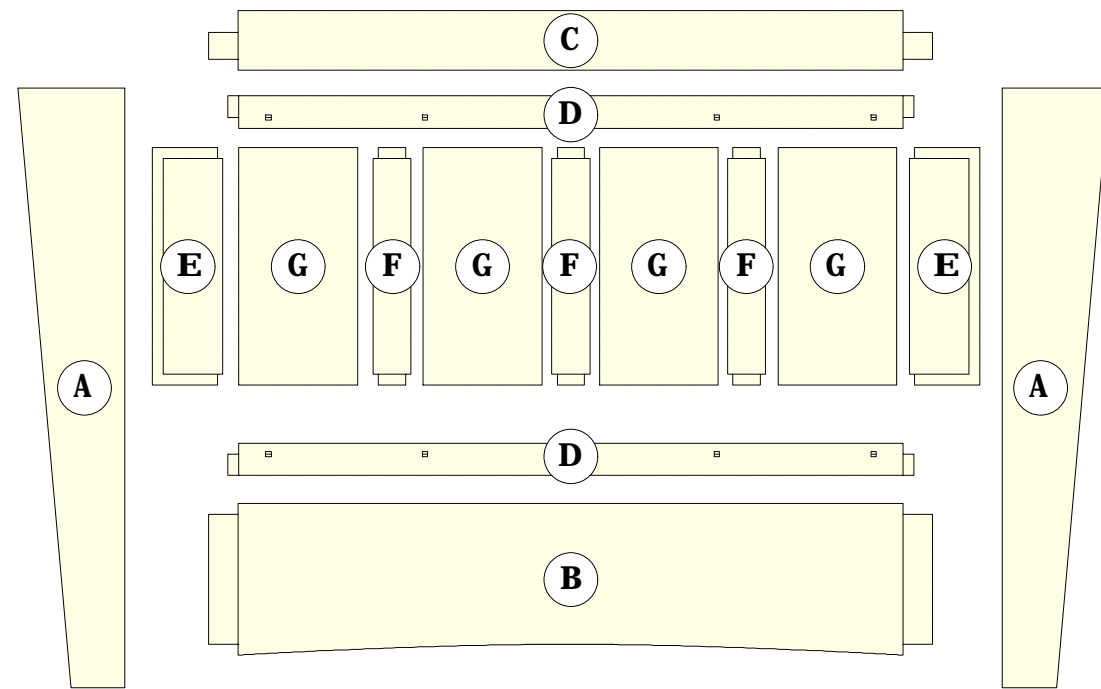

- A) Leg
- B) Lower Rear Rail
- C) Upper Rear Rail
- D) Rear Sub-Rail
- E) Rear Stile
- F) Muntin
- G) Panel

Exploded View of Leg Assembly

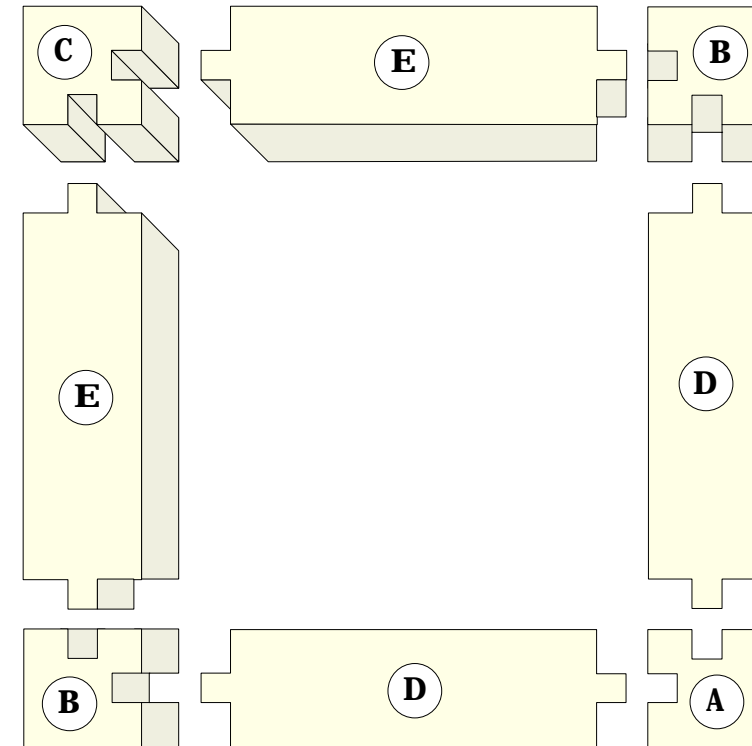

- A) Inner Leg Post
- B) Corner Leg Post
- C) Outer Leg Post
- D) Inner Leg Section
- E) Outer Leg Section

Exploded View of Chair Side

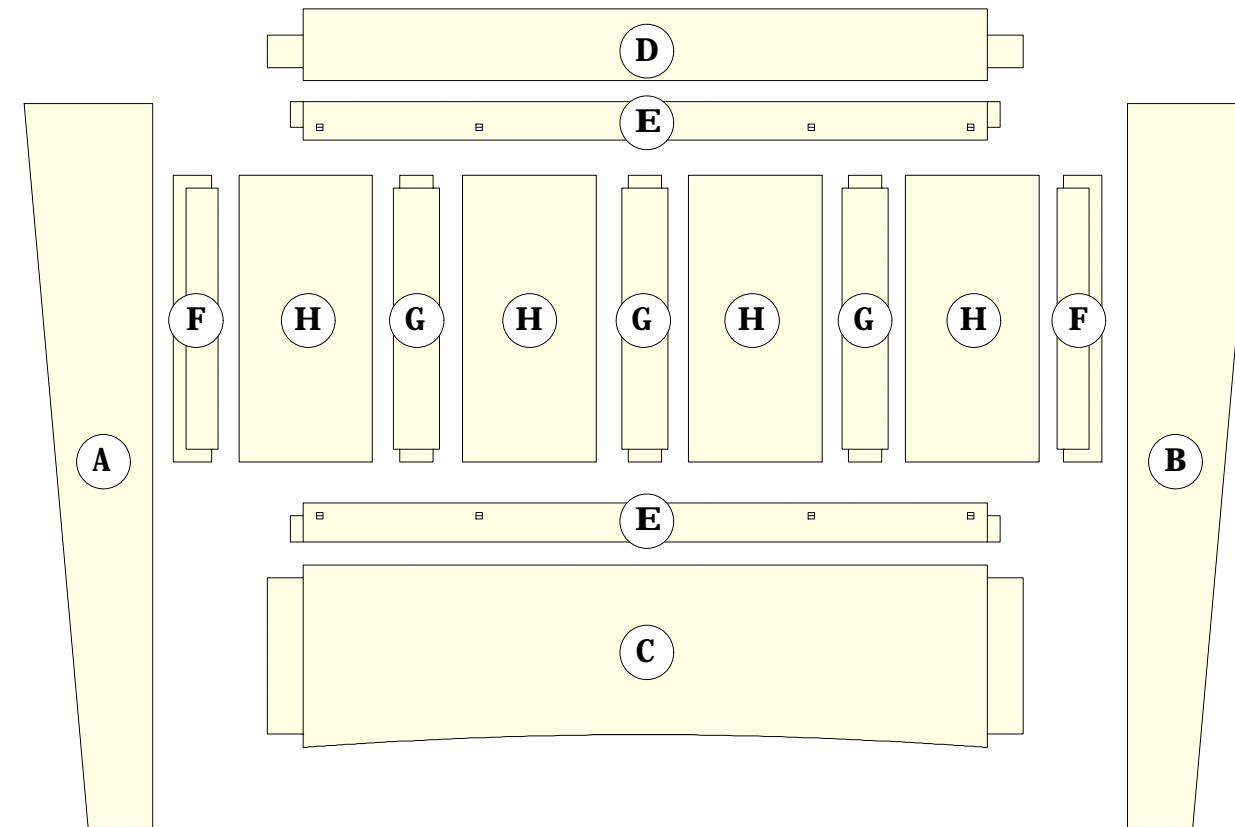

- A) Rear Leg**
- B) Front Leg**
- C) Lower Side Rail**
- D) Upper Side Rail**
- E) Side Sub-Rail**
- F) Side Stile**
- G) Muntin**
- H) Panel**

Positioning of Seat Frame Support and Spacers

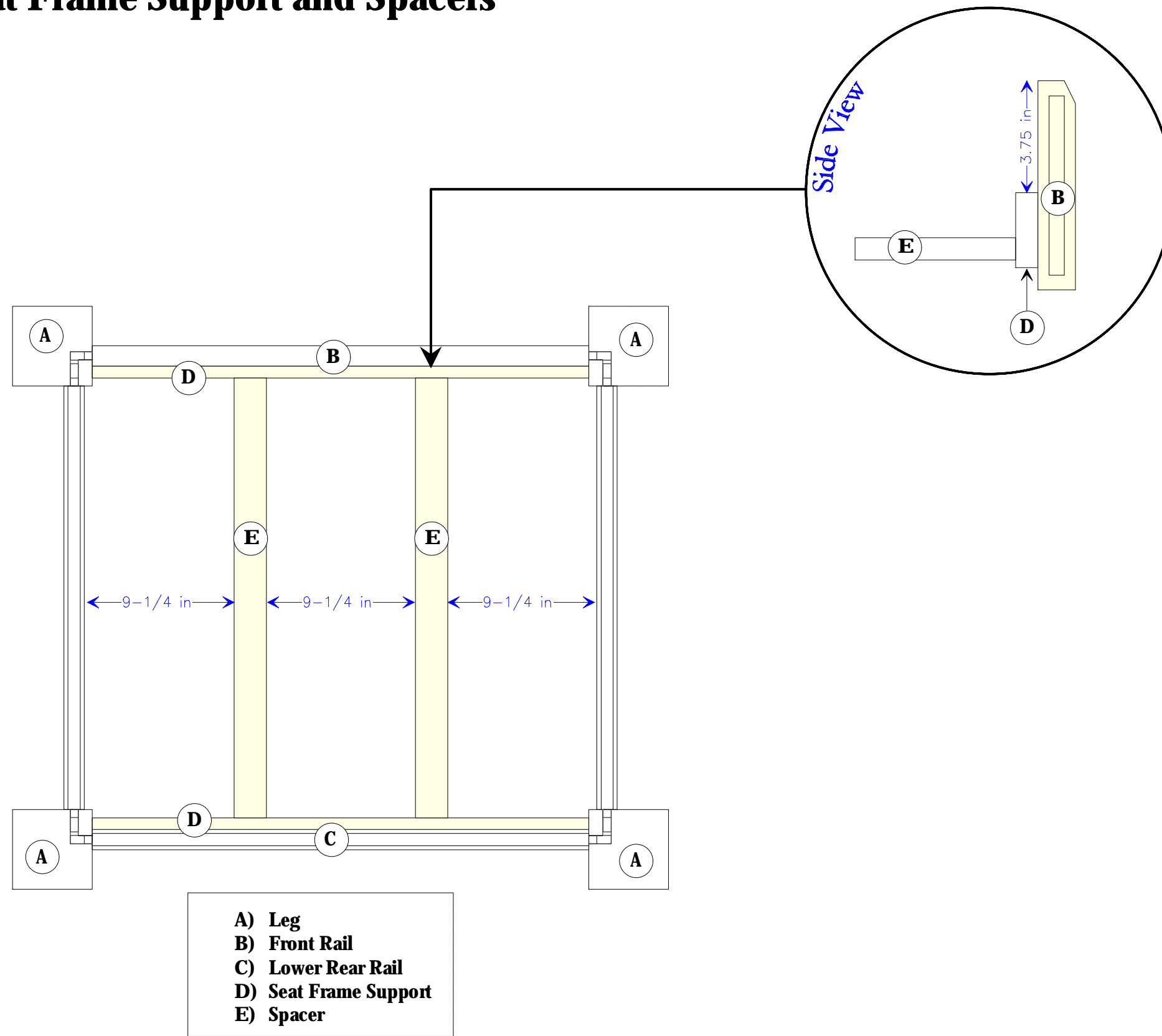

Inner Leg Post (4 Each)

Top View

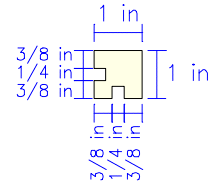

Side View



Corner Leg Post (8 Each)

Top View

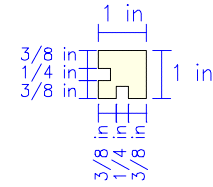

Side View

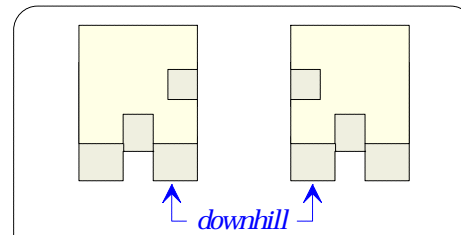
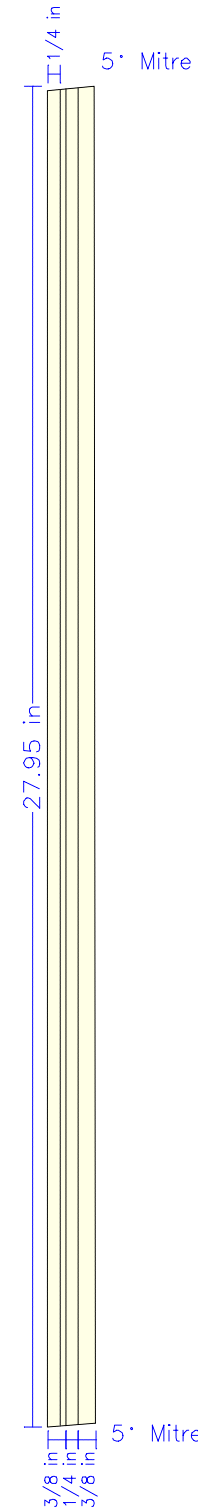

Note: There is always a dado slot on the *downhill* side of the section. However four of the sections will have a dado to the *left* of the downhill dado and four will have a dado to the *right* of the downhill dado.

Outter Leg Post (4 Each)

Top View

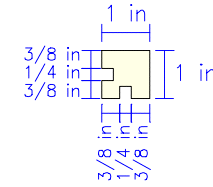

Side View

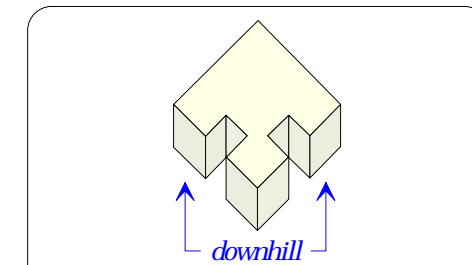
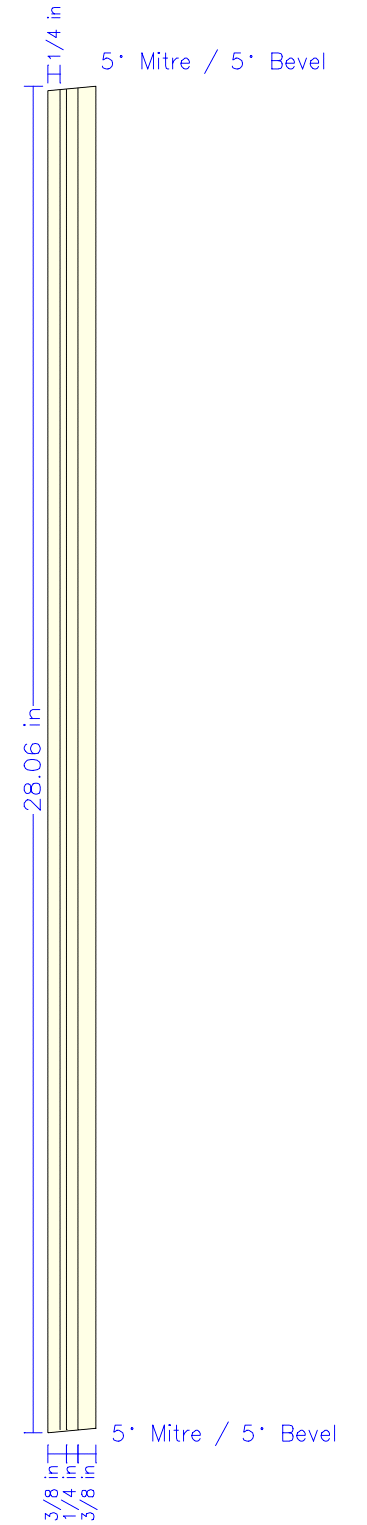

Note: The dados for these pieces are always cut in the downhill edges. It is often easier to cut this leg segment longer than needed and then cut the bottom of the leg to length once it has been assembled.

Inner Leg Section (8 Each)

Front View

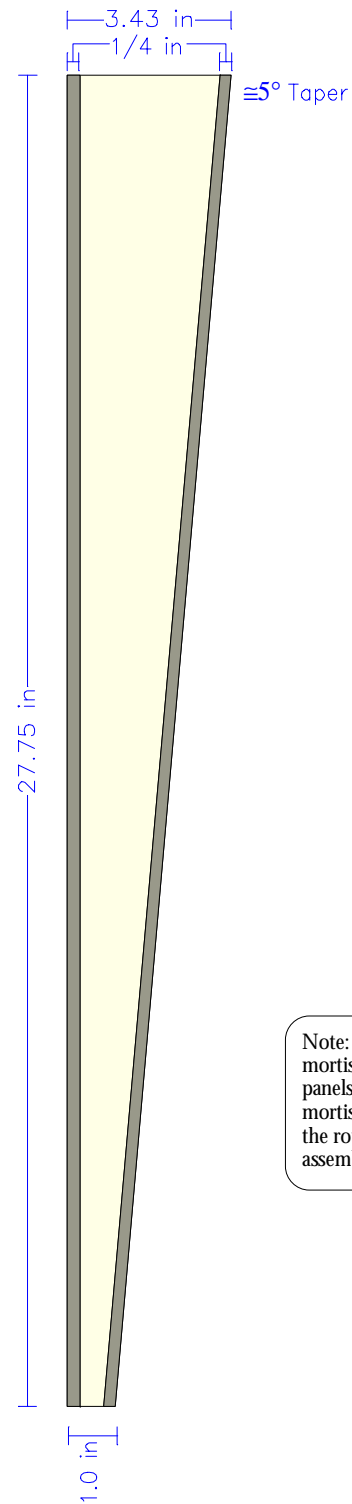

Side View

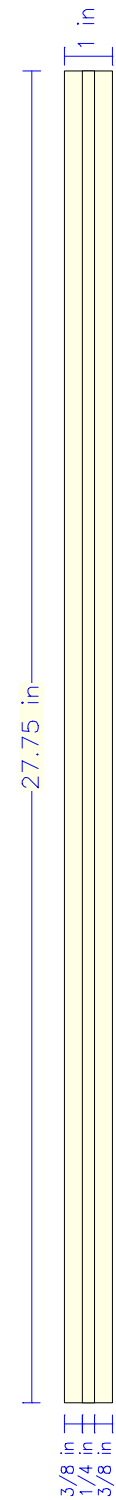

Note: These sections will receive mortises for the stretchers and side panels. It is easier to cut these mortises using a 1/2" straight bit on the router once the legs have been assembled and trimmed to length.

Outer Leg Section (8 Each)

Front View

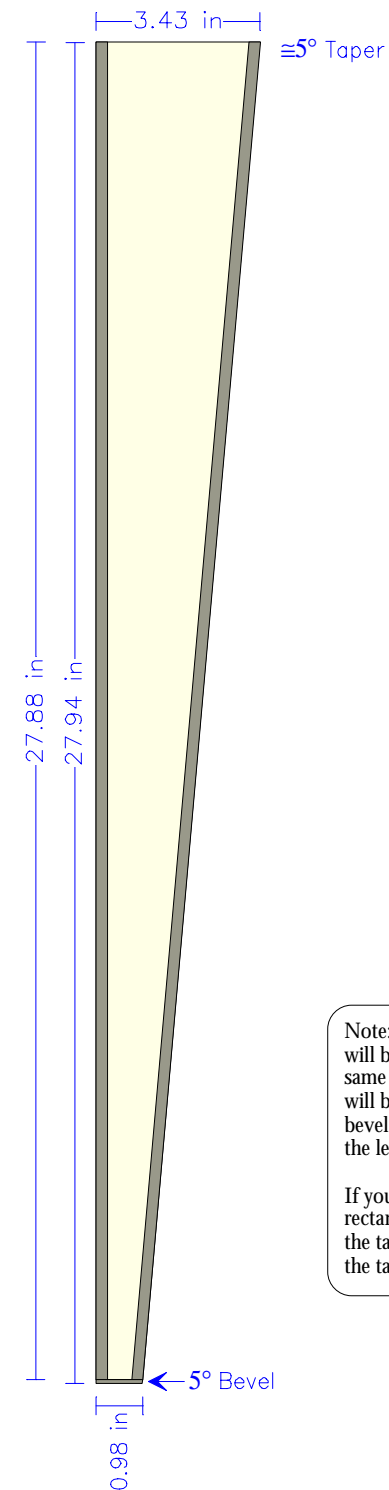

Side View

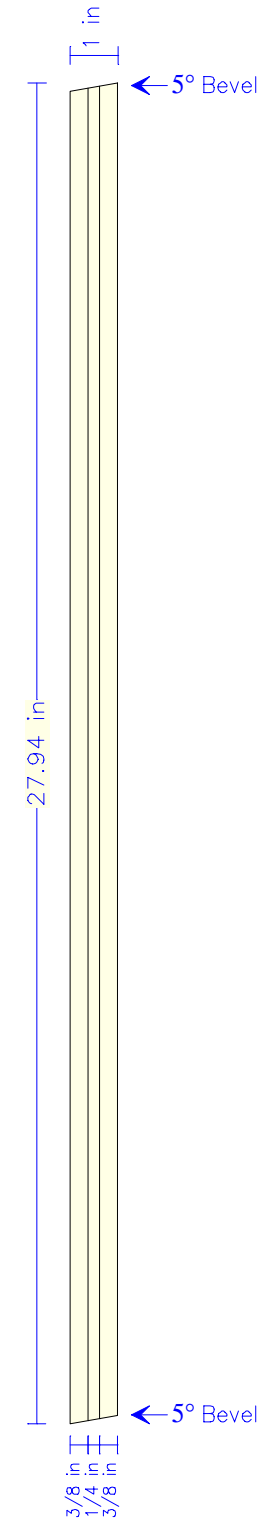

Note: Because these two sections will be on the opposite side of the same leg, on one section the taper will be to the right of the inside bevel and on the other it will be to the left.

If you cut the 5 degree bevels in the rectangular board prior to cutting the tapered halves - you'll end up with the tapers properly oriented.

Back Panel (4 Each)

Front View

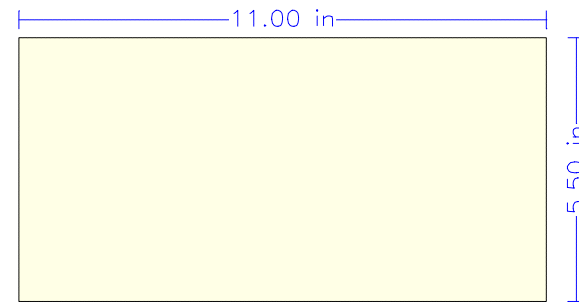

Side View

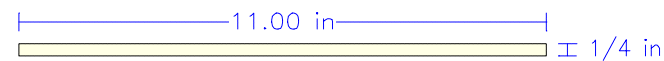

End View

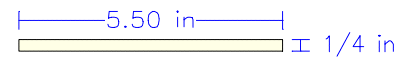

Rear Stile (2 Each)

Front View

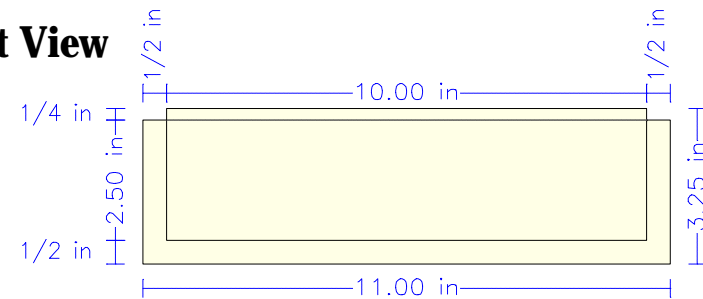

Side View

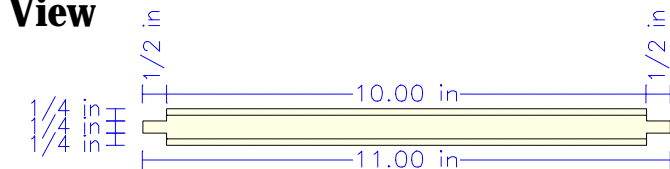

End View

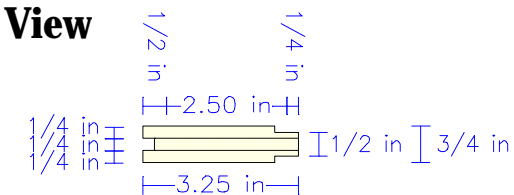

Lower Side Rail (2 Each)

Front View

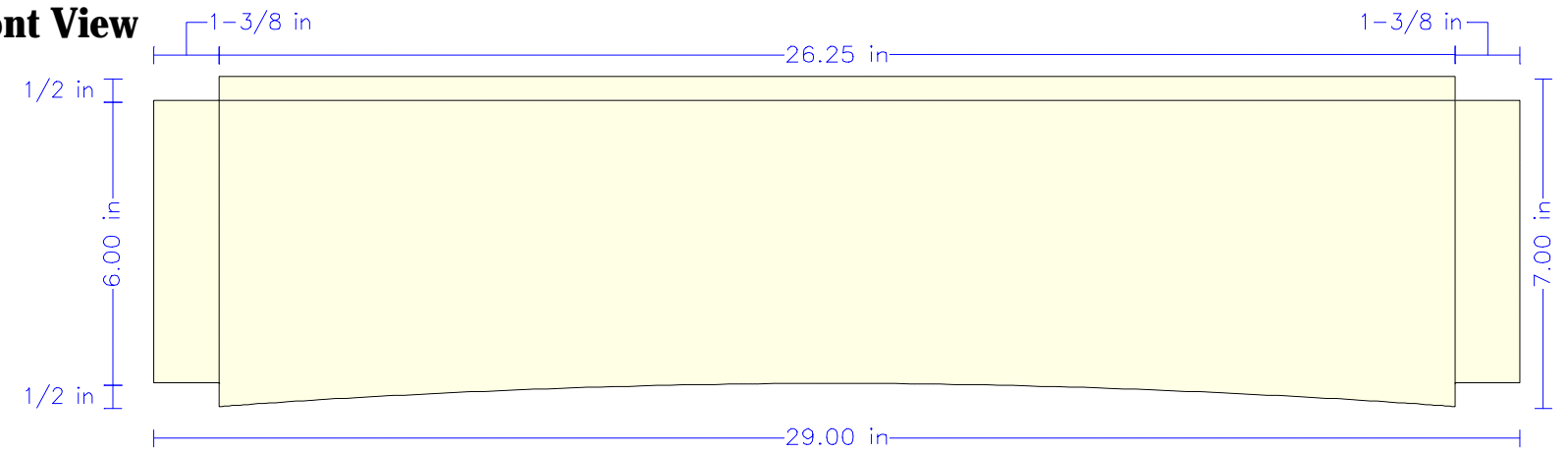

Top View

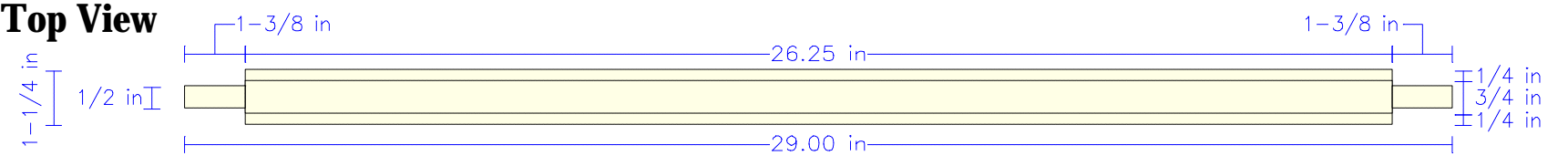

End View

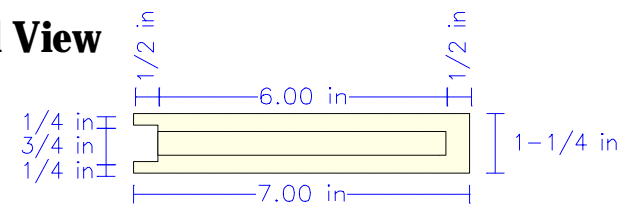

Upper Side Rail (2 Each)

Front View

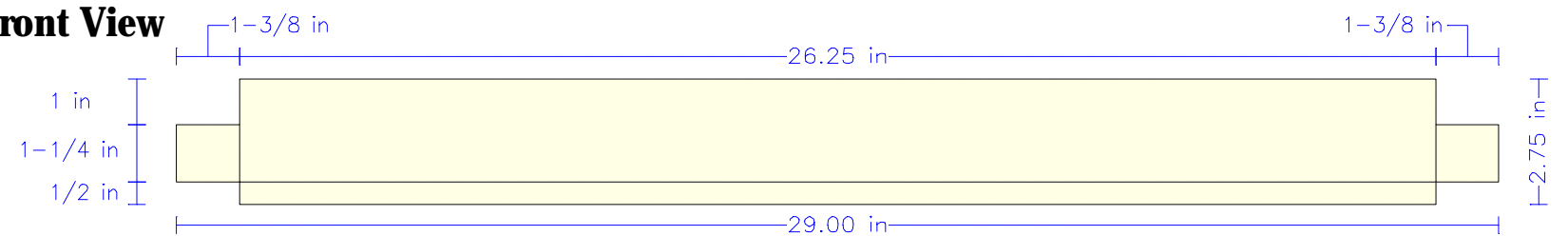

Top View

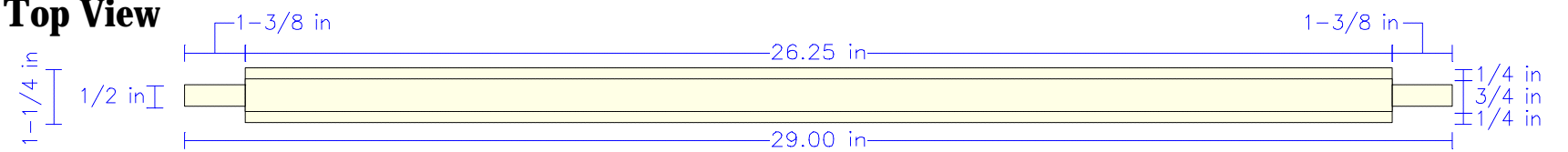

End View

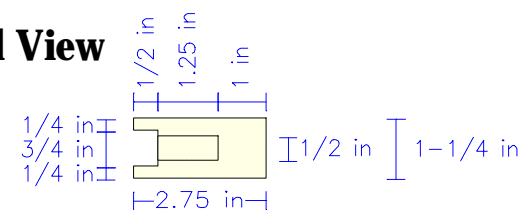

Side Sub-Rails (4 Each)

Front View

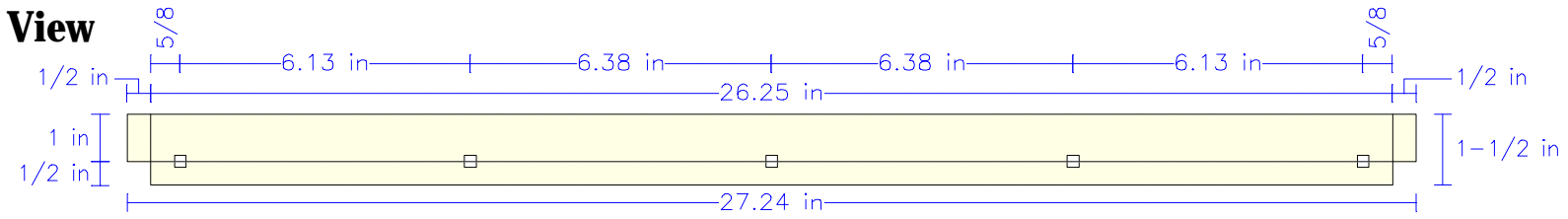

Top View

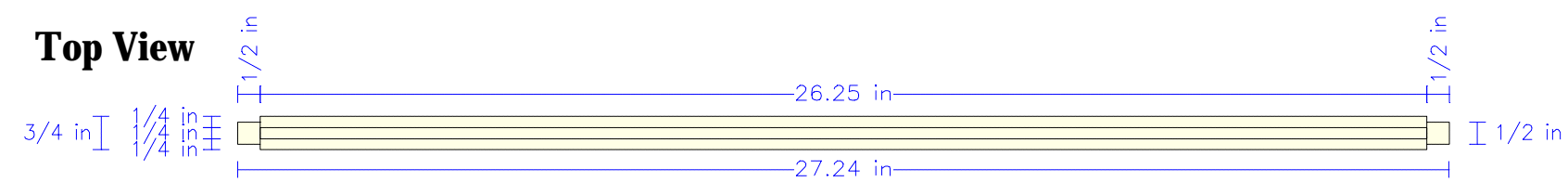

End View

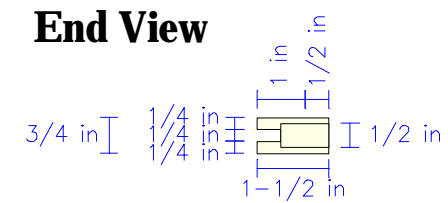

Dental Insert (18 Each)

Top View

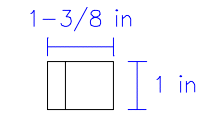

Side View

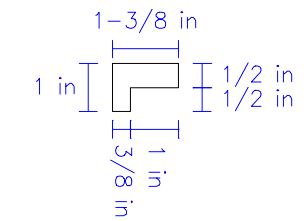

End View

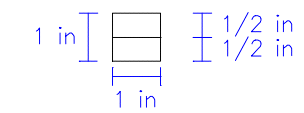

Arm Rest (2 Each)

Front View

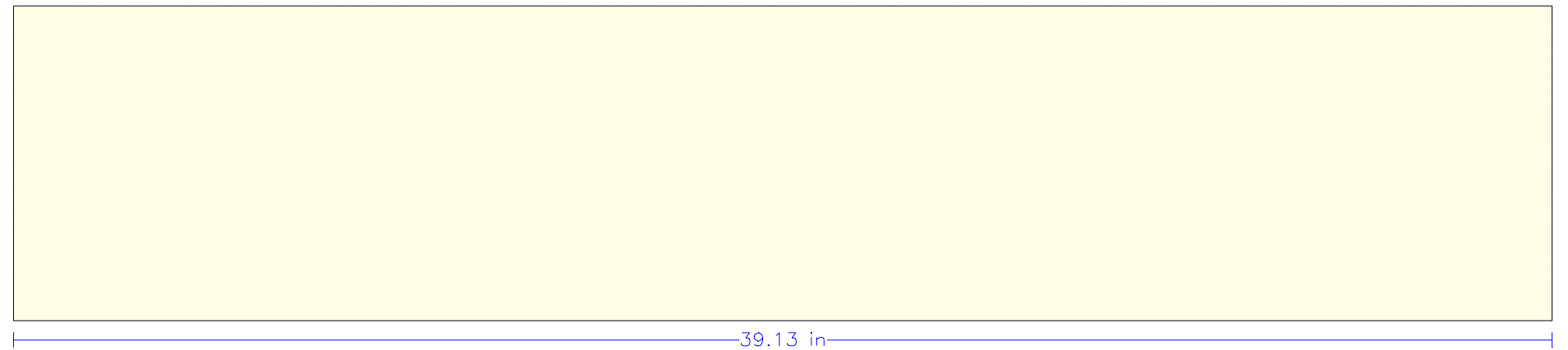

Top View

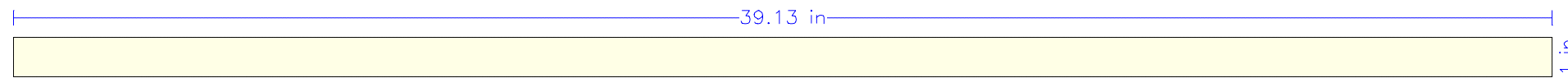

End View

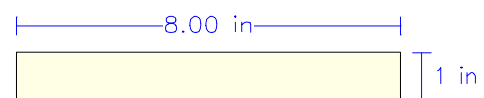

Lower Rear Rail (1 Each)

Front View

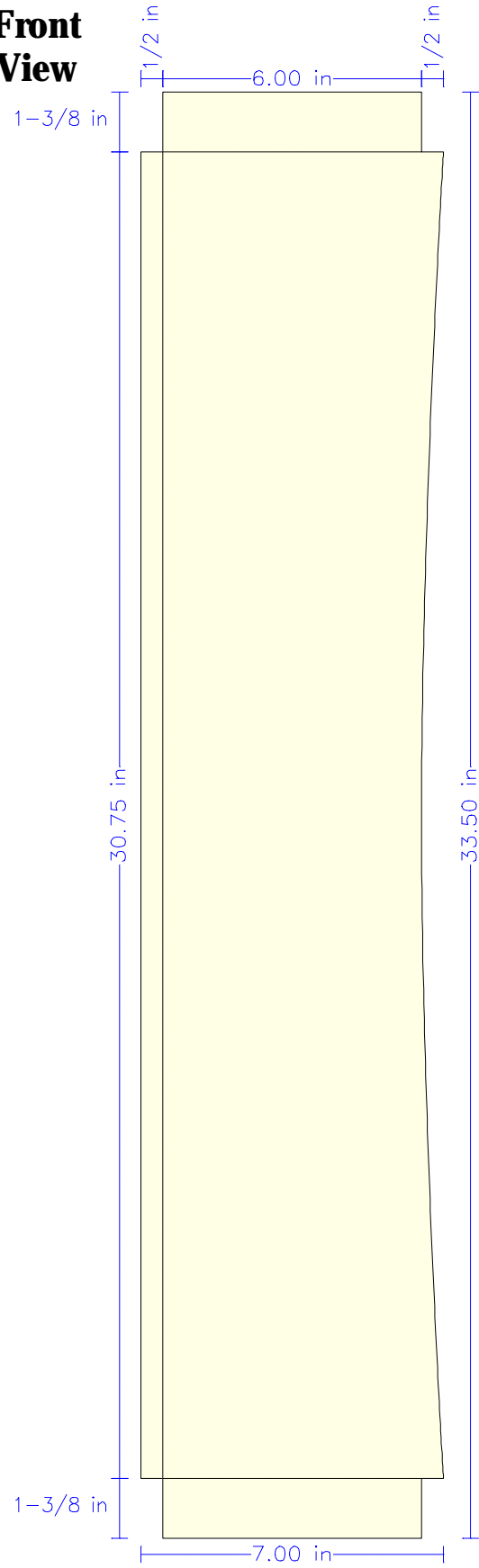

Top View

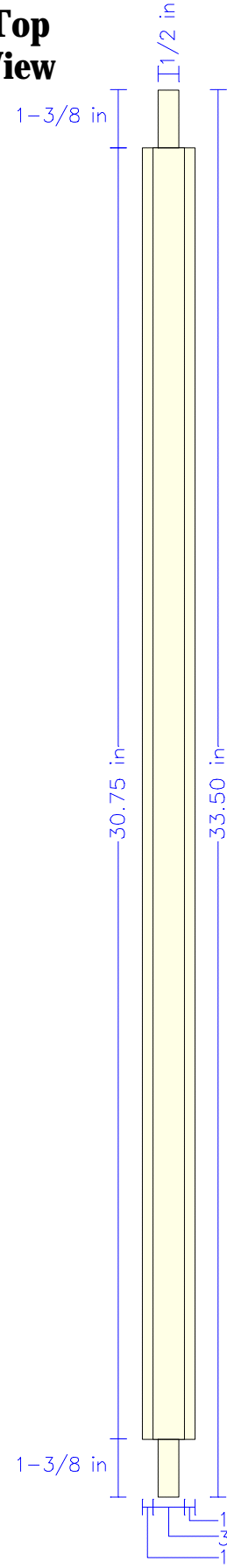

End View

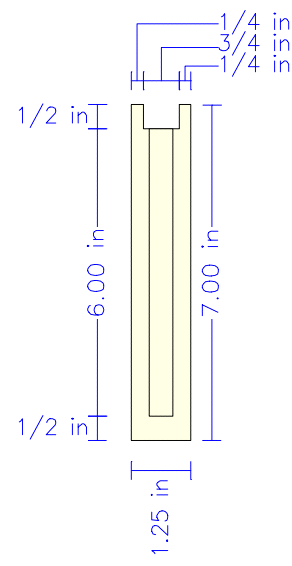

Front Rail (1 Each)

Front View

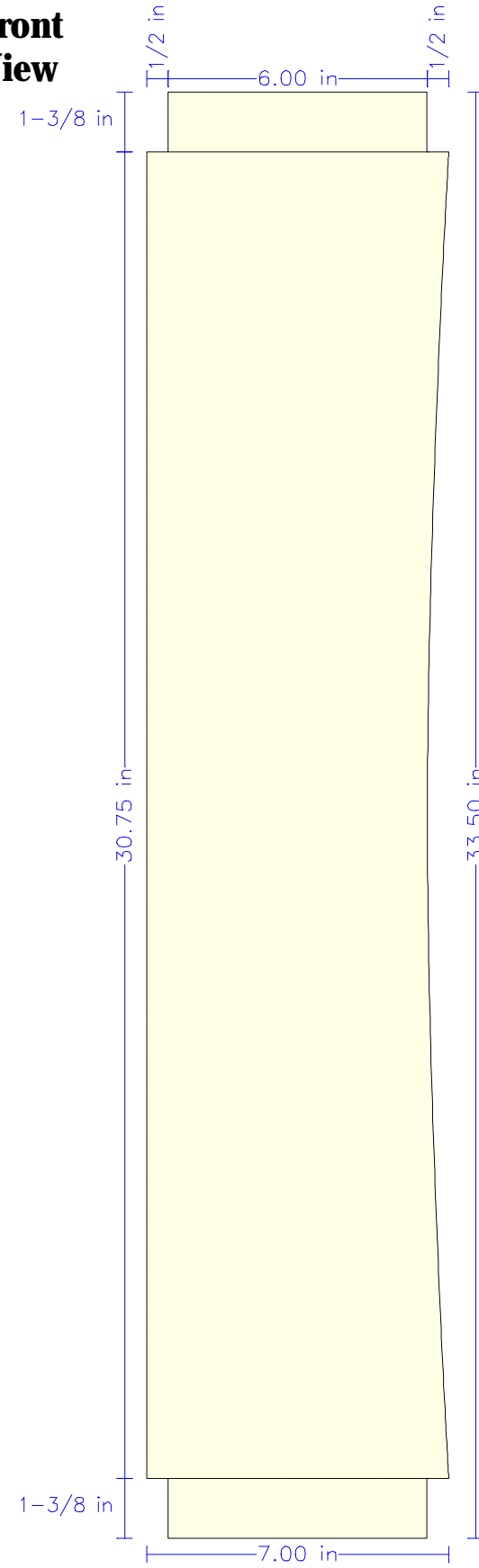

Top View

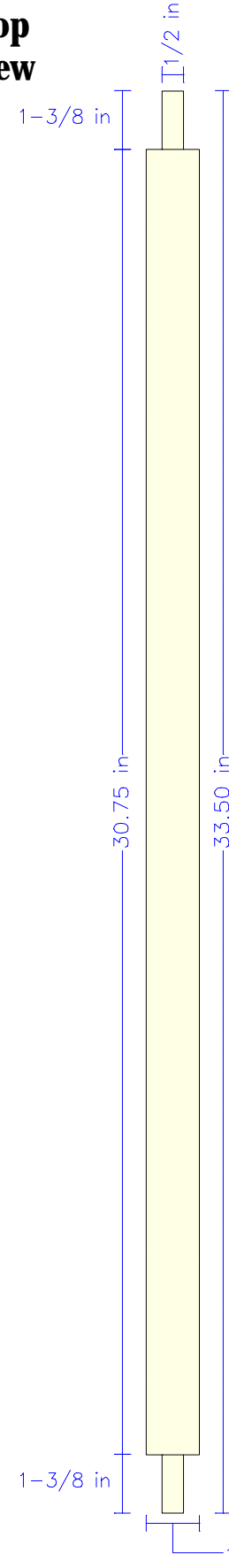

End View

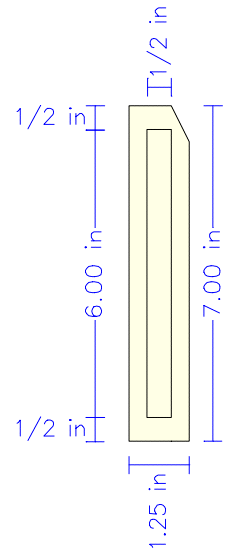

Upper Rear Rail (1 Each)

Front View

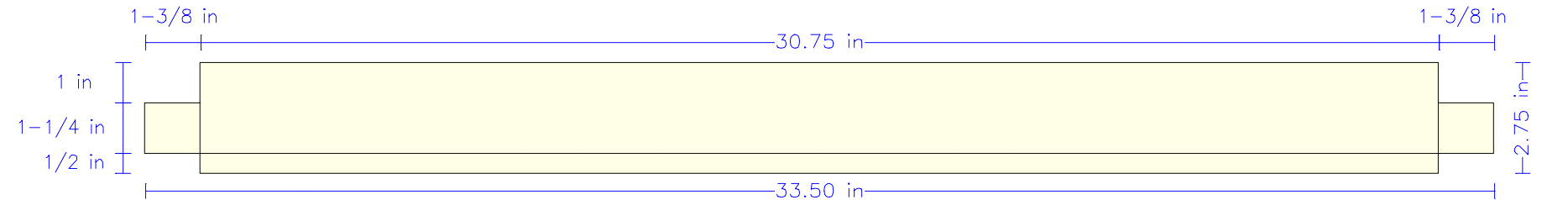

Top View

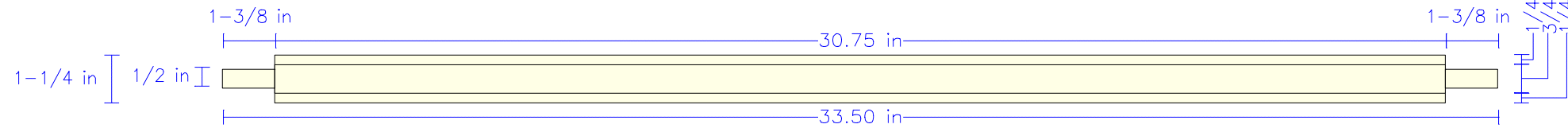

End View

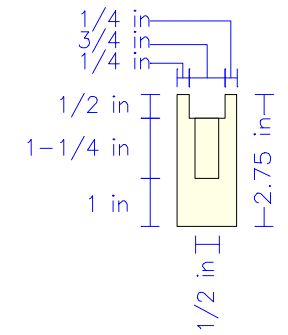

Rear Sub-Rail (2 Each)

Front View

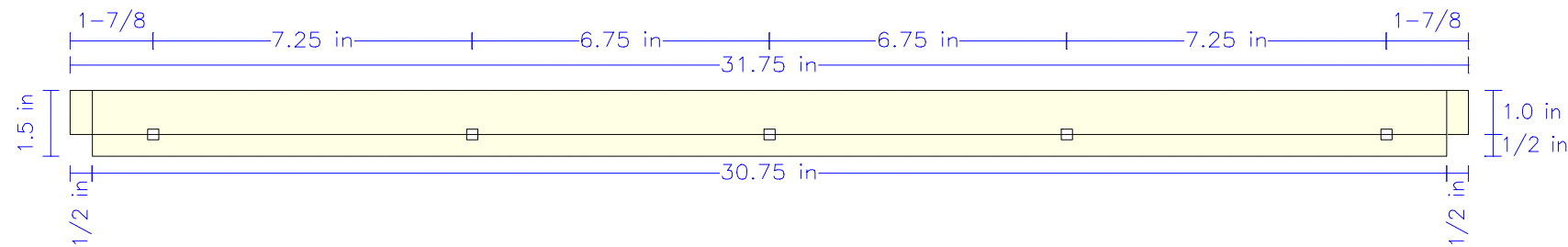

Top View

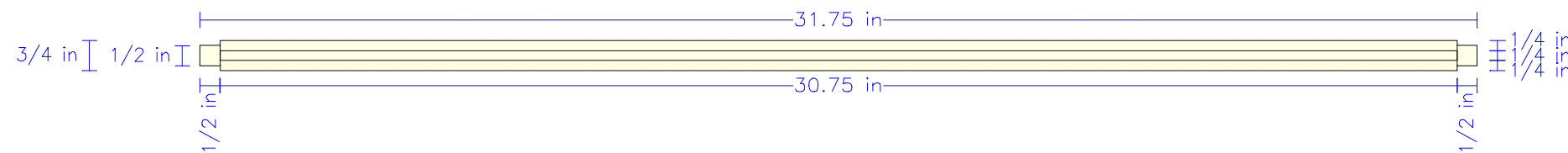

End View

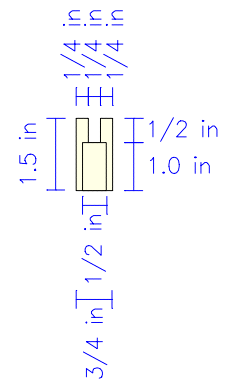

Seat Spacer (2 Each)

Front View

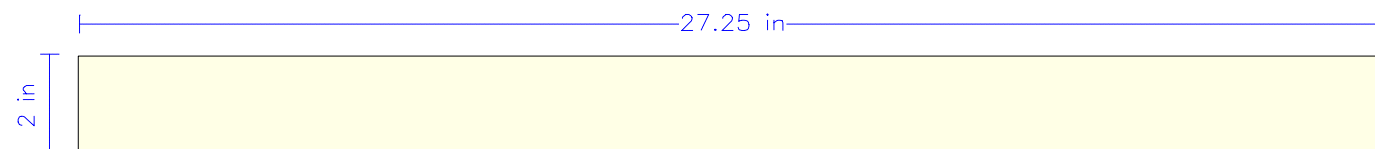

Top View

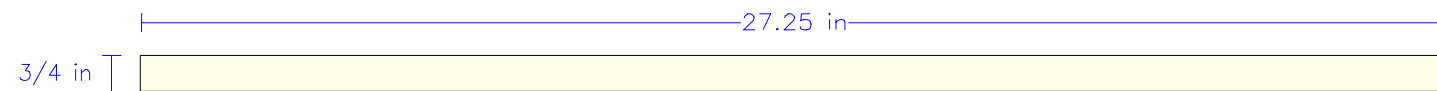

End View

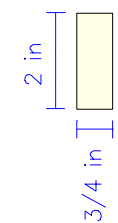

Rear Arm Rest (1 Each)

Top View

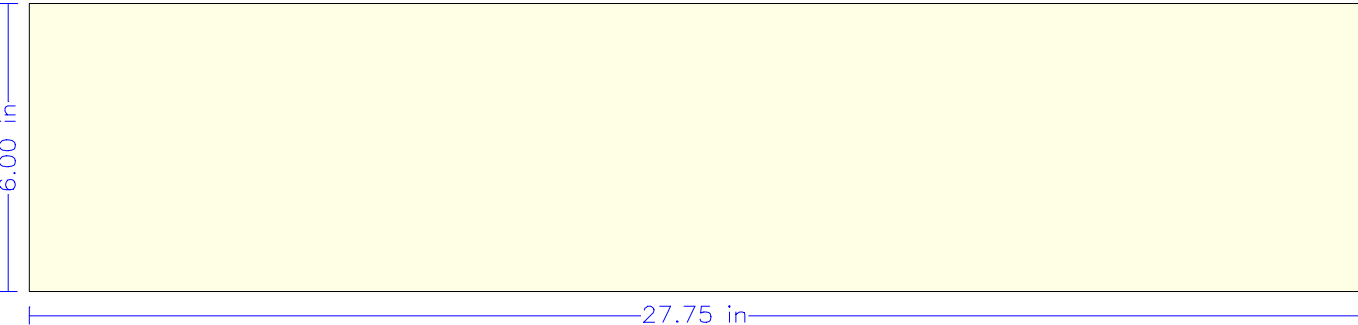

Front View

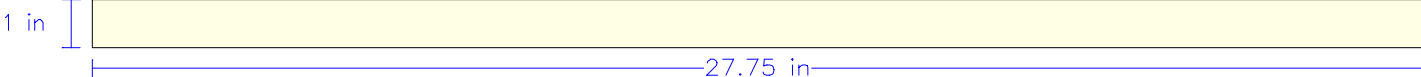

End View

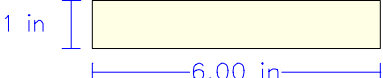

Seat Frame Support (2 Each)

Front View

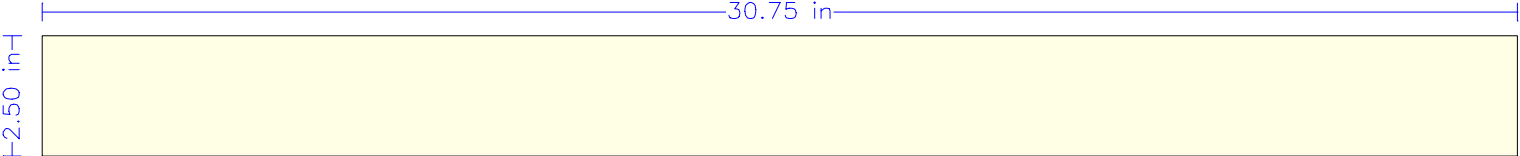

Side View

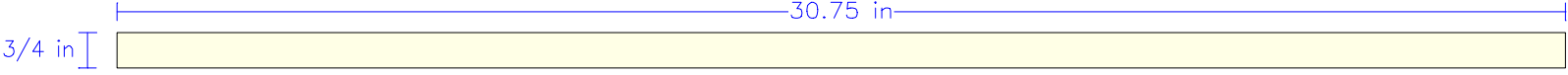

End View

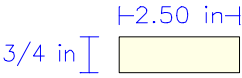

Side SubArm Rest (2 Each)

Front View

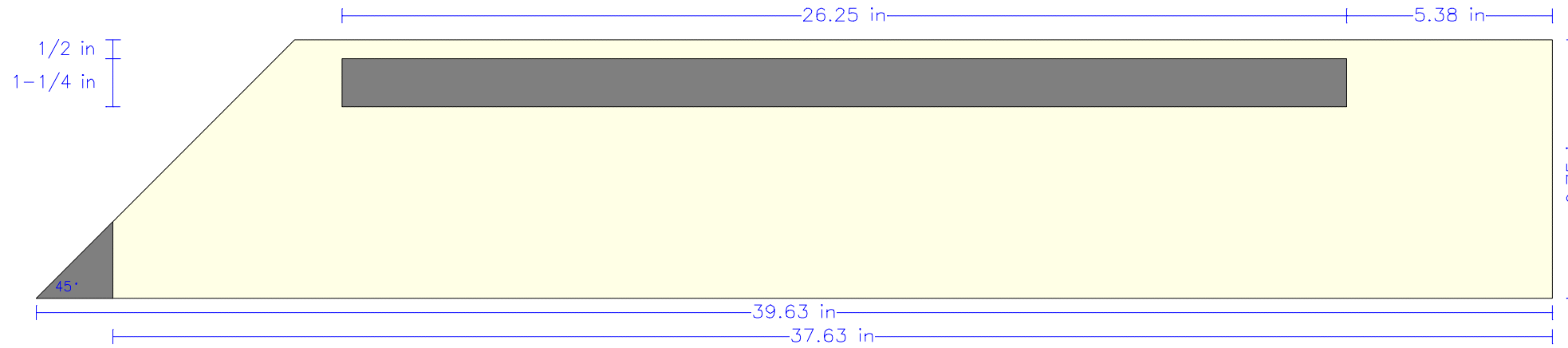

Side View

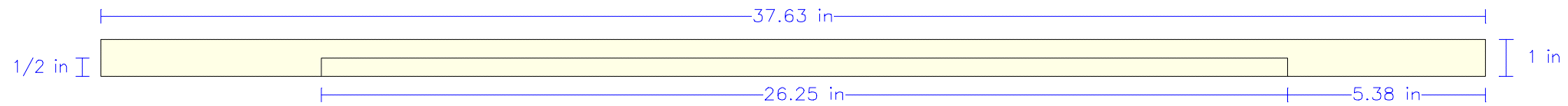

End View

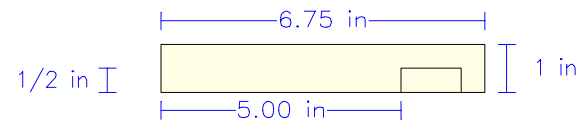

Rear SubArm Rest (1 Each)

Front View

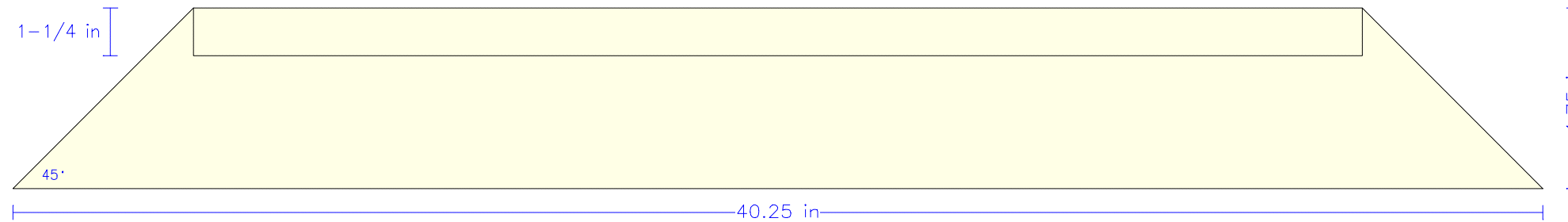

Side View

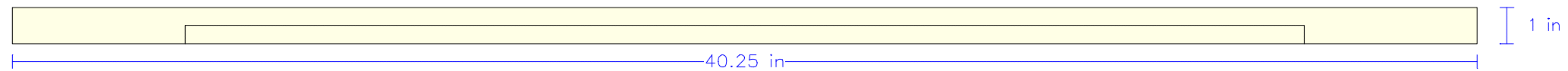

End View

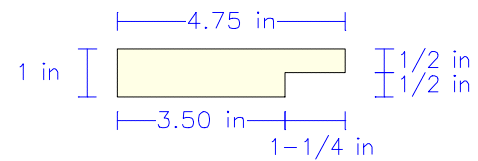

Rear Arm Rest MidSection (1 Each)

Front View

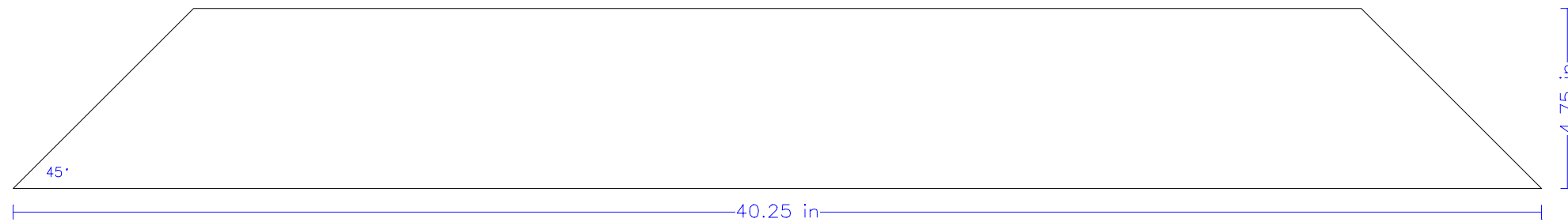

Side View

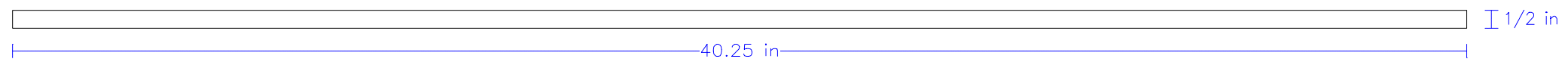

End View

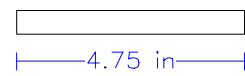

Side Arm Rest MidSection (2 Each)

Front View

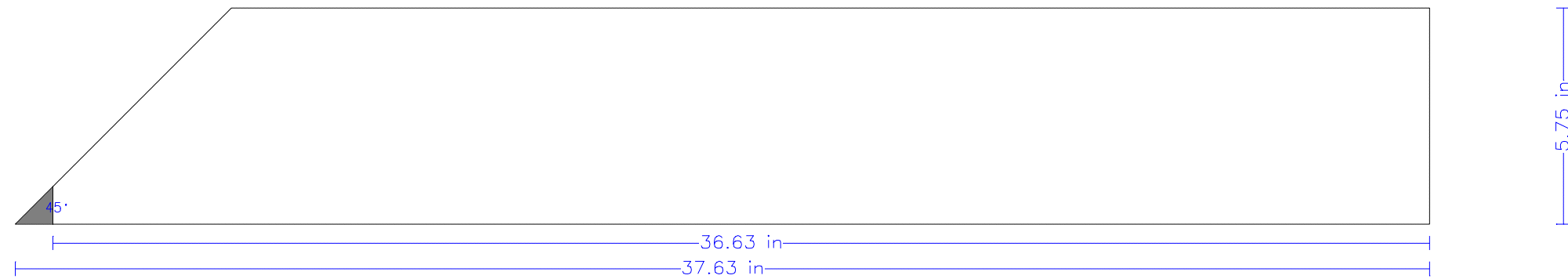

Side View

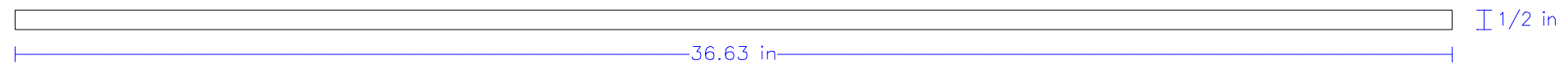

End View

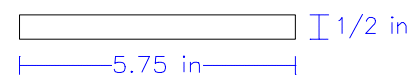

Muntin (9 Each)

Front View

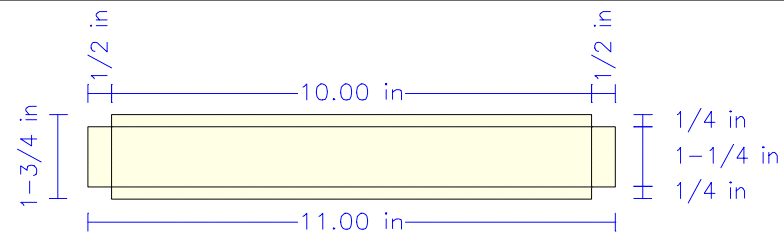

Side View

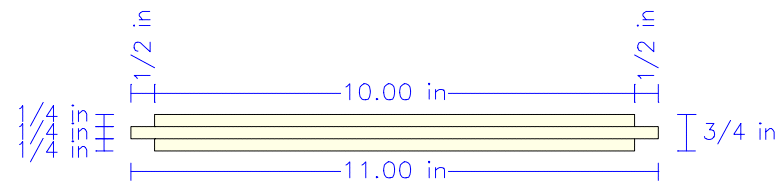

End View

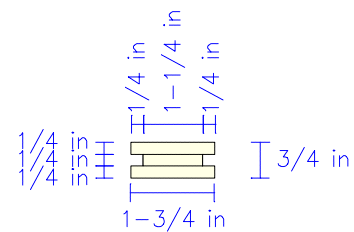

Side Stile (4 Each)

Front View

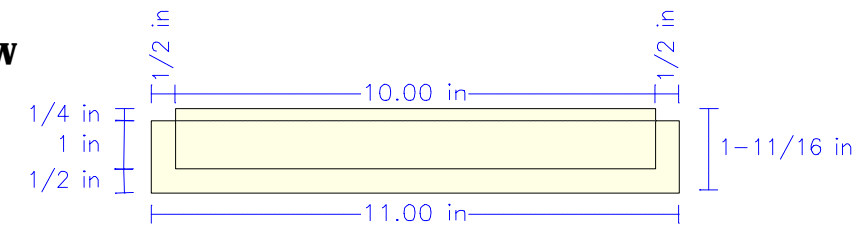

Side View

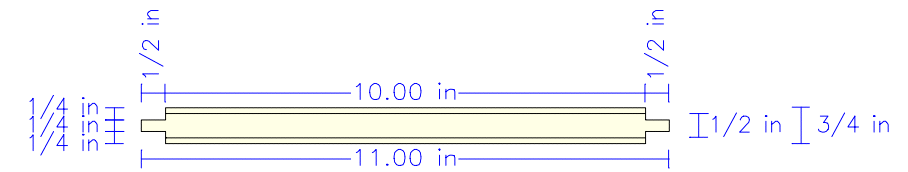

End View

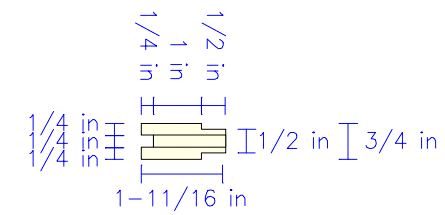

Side Panel (8 Each)

Front View

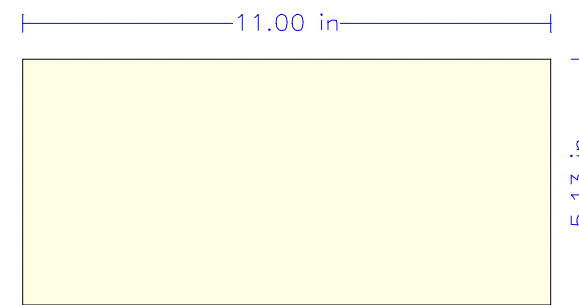

Side View

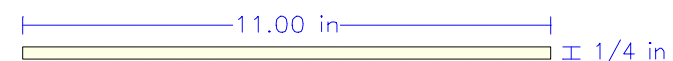

End View



Mortises for Assembled Rear Legs

Side View

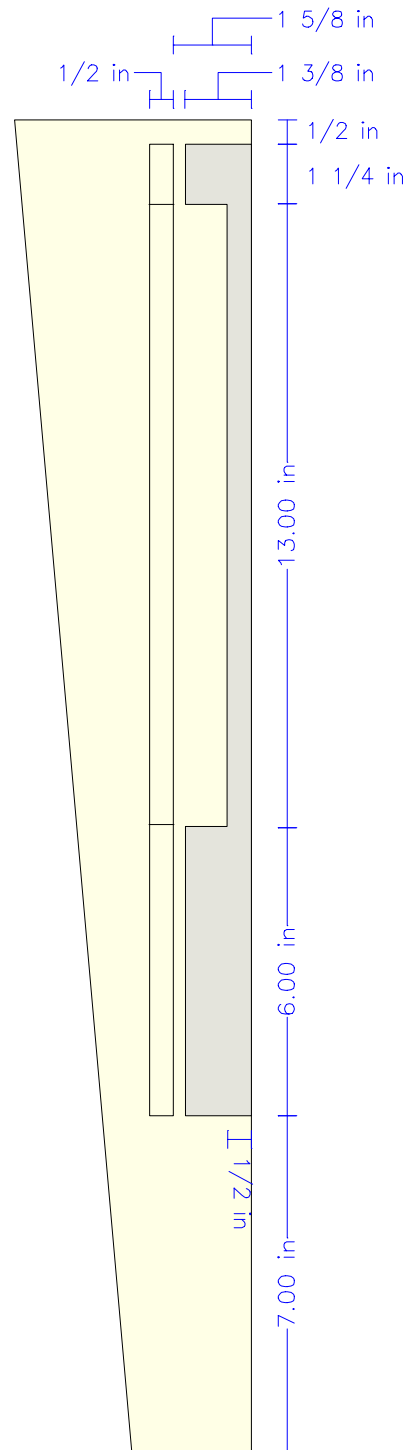

Front View

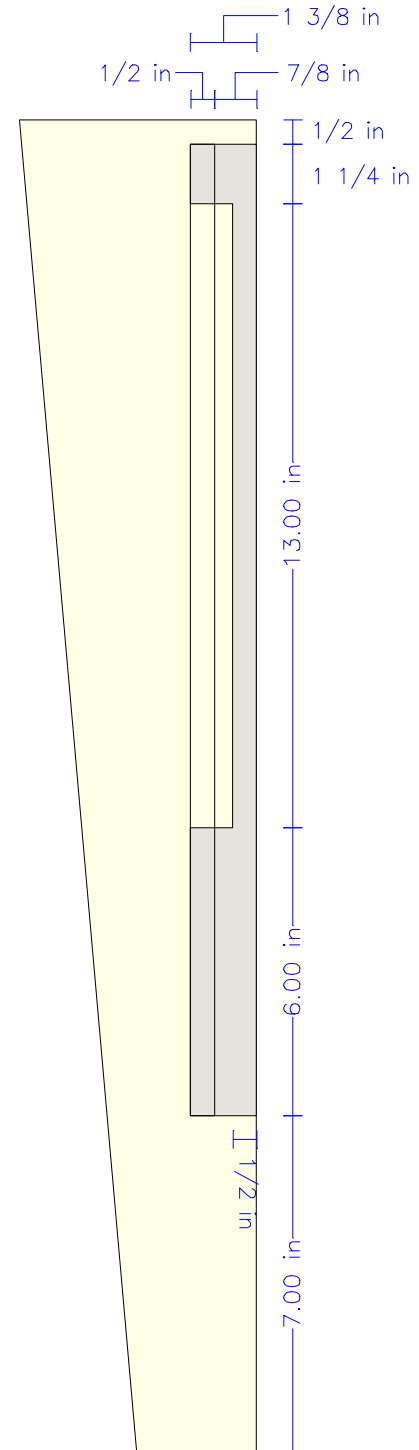

Note: As the diagram illustrates, the mortises for the rear panels start 1-5/8 inches from the edge of the leg, while the mortises for the side panels start 7/8 inches from the edge of the leg.

When preparing to make these cuts, remember that mortises are ONLY cut in the sides that are perpendicular to the floor.

Mortises for Assembled Front Legs

Side View

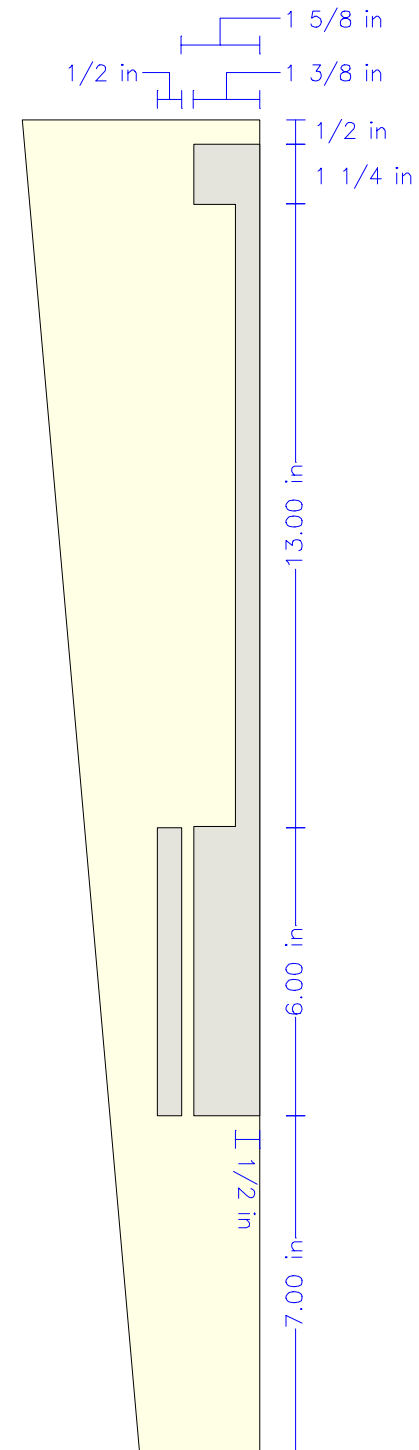

Front View

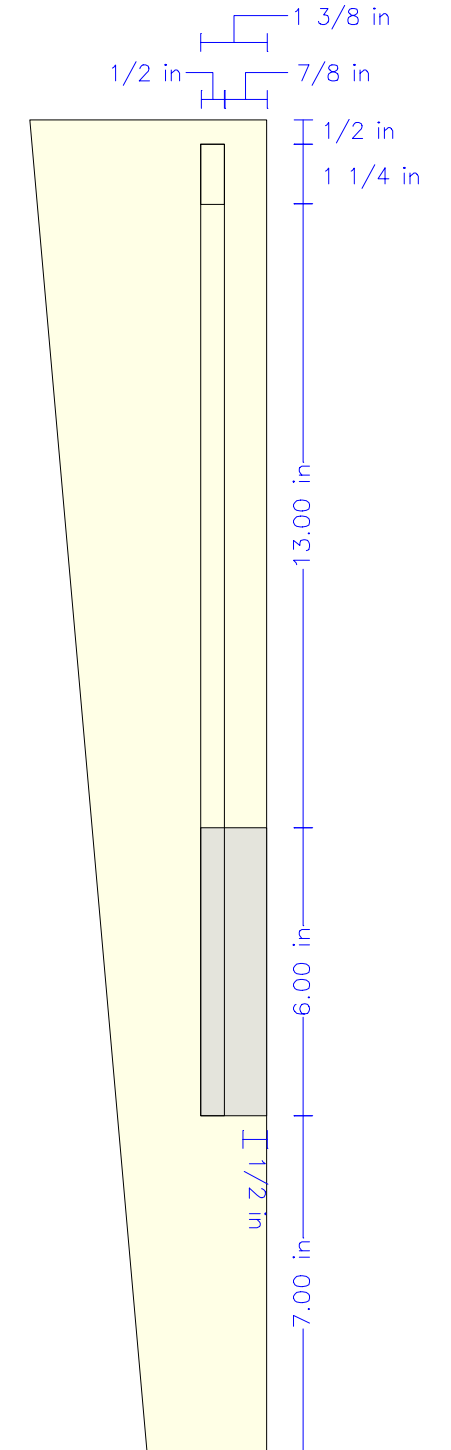

Note: As the diagram illustrates, the mortise for the front stretcher starts 1-5/8 inches from the edge of the leg, while the mortises for the side panels start 7/8 inches from the edge of the leg.