

Kitchen Island



Leg Dimensions

Step 1 - Cut the legs (A) slightly longer than the dimensions given in the material list. For the thickness we need, the legs are cut from a piece of 1½"-thick stock, ripped to 3" wide, as shown in photo A and A inset.



Leg Glue-Up

Step 2 - Use some wood glue (R) and lots of clamps to gang a pair of legs together, as shown in photo B.



Rails

Step 3 - Cut all the rails (B-G) to the dimensions given in the material list. Use the radial arm saw to make the cross cuts and the table saw to make the ripped cuts, as shown in photo C.



We call this project a kitchen island, but after its completion, we decided that it could be used in a craft room, sewing room or any place that requires the ease of a cart that moves around. So don't let the title fool you; we're sure you have some room in your house for this handy cart on wheels.

Drawer Exploded View

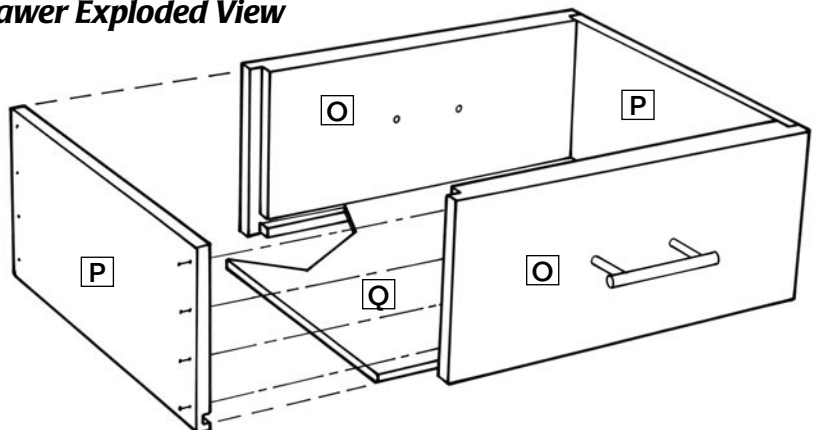

Kitchen Island

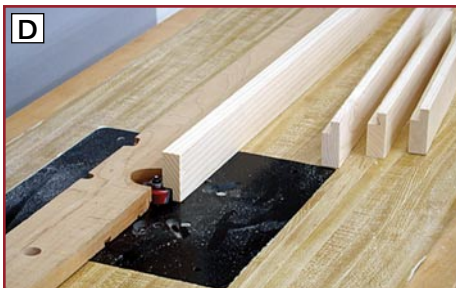

Rabbeting

Step 4 - The middle and bottom rails, both long and short, receive a $\frac{3}{8}$ "-wide by $\frac{1}{2}$ "-deep rabbet along their inside top edge. Use the router in the router table with a rabbeting bit adjusted to make the appropriate rabbet and a fence to add stability, as shown in photo D.



Scrapper

Step 5 - After the glue has dried in the legs, use a scraper to remove the squeezed-out glue on each leg, as shown in photo E.



Final Length

Step 6 - Use the radial arm saw to trim both ends of the legs to achieve your final length of 31", as shown in photo F.

Material List

T x W x L

A	legs (8) <i>pine</i>	3" x 3" x 31"
B	bottom long rails (2) <i>pine</i>	$\frac{3}{4}$ " x 2" x 28 $\frac{1}{4}$ "
C	bottom short rails (2) <i>pine</i>	$\frac{3}{4}$ " x 2" x 13 $\frac{1}{2}$ "
D	middle long rails (2) <i>pine</i>	$\frac{3}{4}$ " x 1 $\frac{1}{2}$ " x 28 $\frac{1}{4}$ "
E	middle short rails (2) <i>pine</i>	$\frac{3}{4}$ " x 1 $\frac{1}{2}$ " x 13 $\frac{1}{2}$ "
F	top long rails (2) <i>pine</i>	$\frac{3}{4}$ " x 2" x 28 $\frac{1}{4}$ "
G	top short rails (2) <i>pine</i>	$\frac{3}{4}$ " x 2" x 13 $\frac{1}{2}$ "
H	bottom shelf <i>birch plywood</i>	$\frac{1}{2}$ " x 15" x 29 $\frac{3}{4}$ "
I	middle shelf <i>birch plywood</i>	$\frac{1}{2}$ " x 15" x 29 $\frac{3}{4}$ "
J	top (11) <i>maple</i>	1 $\frac{3}{4}$ " x 1 $\frac{3}{4}$ " x 36"
K	center drawer divider <i>maple</i>	$\frac{3}{4}$ " x 8" x 15 $\frac{3}{4}$ "
L	side drawer guides (2) <i>maple</i>	$\frac{1}{2}$ " x $\frac{1}{2}$ " x 12"
M	upper drawer guides (2) <i>pine</i>	$\frac{3}{4}$ " x 3" x 14 $\frac{1}{4}$ "
N	top mounting clips (6) <i>pine</i>	$\frac{3}{4}$ " x 2" x 2"
O	drawer fronts (4) <i>maple</i>	$\frac{3}{4}$ " x 515/16" x 1215/16"
P	drawer sides (4) <i>maple</i>	$\frac{1}{2}$ " x 515/16" x 15"
Q	drawer bottoms (2) <i>birch plywood</i>	$\frac{1}{4}$ " x 127/16" x 15"

Supply List

R	wood glue	waterproof
S	biscuits (4)	#10
T	center drawer divider wood screws (5)	#6 x 1 $\frac{1}{4}$ "
U	maple buttons (2)	$\frac{1}{2}$ "
V	brads	$\frac{3}{4}$ "
W	wood filler	
X	American Accents paint (pint)	hunt club green satin finish
Y	butcher block oil	
Z	Watco oil	natural
AA	drawer pulls (4)	
BB	mounting clip wood screws (6)	#6 x 1 $\frac{5}{8}$ "
CC	Varathane spray finish	
DD	wheels	1 $\frac{3}{4}$ " x 2 $\frac{1}{4}$ " x 2 $\frac{3}{4}$ "



Witness Marks

Step 7 - It's always best to make the mortises in the legs first, then the tenons on the rails are made to fit. Start by marking each leg right front, left front, right back, and left back. Arrange the legs so the best sides are facing out. The inside faces are where the mortises will be made. Mark each face to avoid confusing yourself, as shown in photo G.



Ganging Legs

Step 8 - Start by making mortises for the long rails. Lay the legs flat with the correct side facing up. Align their bottom edges so that they are all flush and clamped together, as shown in photo H.



Long Rails Mortise Locations

Step 9 - Mark each leg with a top and bottom. Refer to the front and side view drawings for the long rail locations. Using a square and ruler, mark each mortise location on the legs, as shown in photo I.



Mortising

Step 10 - Use the drill press with a $\frac{3}{8}$ " mortising chisel to make the mortises in each leg down to a depth of $\frac{3}{4}$ ", as shown in photo J. If you don't have a mortising attachment for your drill press, a series of $\frac{3}{8}$ " holes drilled to a depth of $\frac{3}{4}$ " will work as well. A sharp chisel will be used to square up the edges.

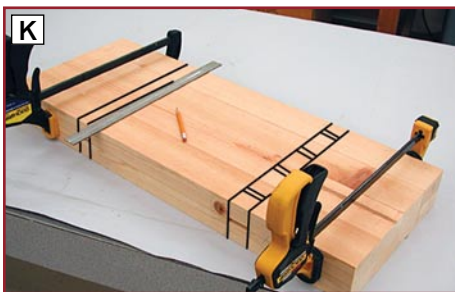

Short Rail Mortise Locations

Step 11 - Lay the legs flat with the short rail mortise side facing up and their bottom edges flush with one another. Clamp all 4 legs together. Refer to the front and side view drawings for mortise locations. Transfer the locations to the legs, as shown in photo K.

Side View

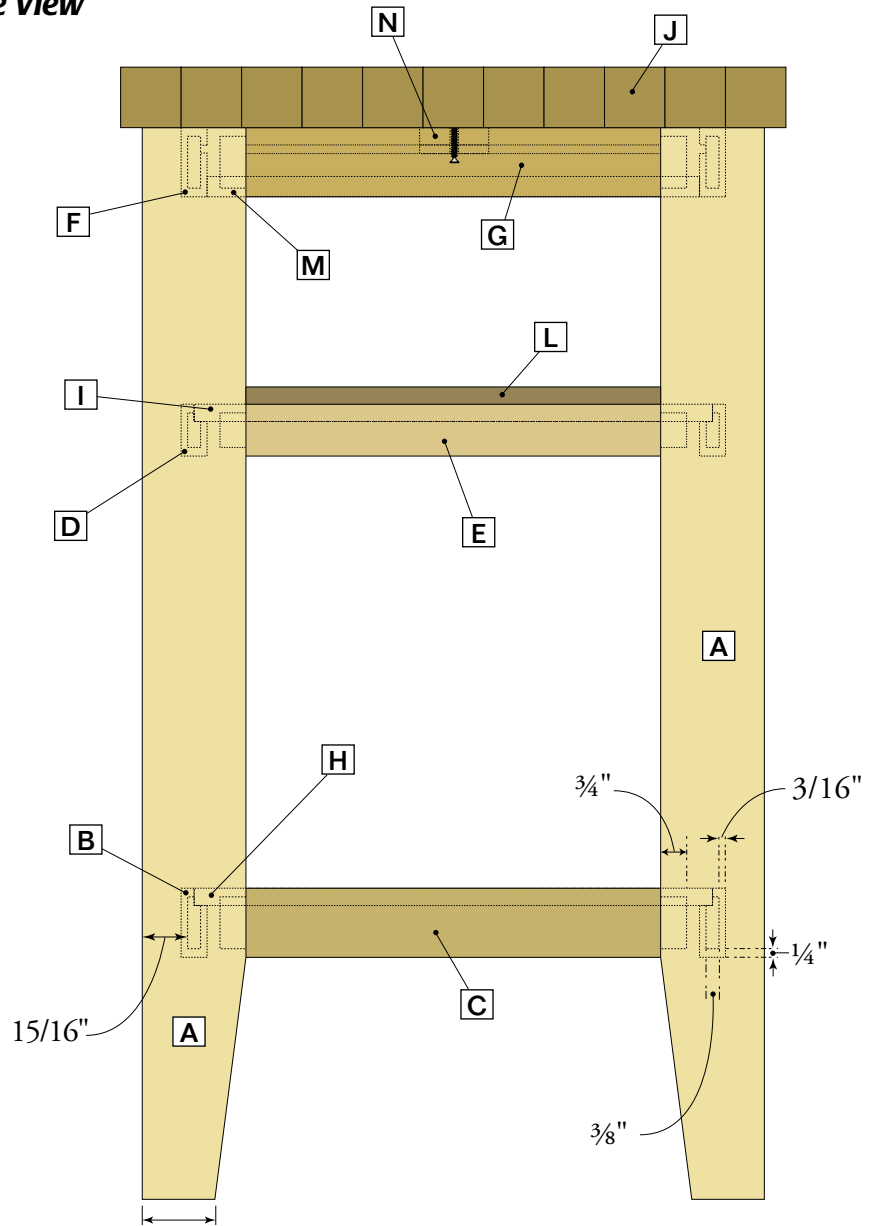

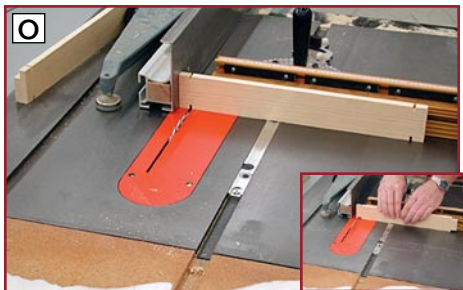
**Shoulder Cuts**

test tenon in some scrap wood to assure proper fitting. Start off by making the shoulder cuts, as shown in photo O. Pass each piece through the blade several times, moving the piece further from the fence with each pass to remove the remaining material, as shown in photo O inset.

**Cheek Cuts**

Step 16 - Lay the rails flat against the table saw surface, and make the cheek cuts, nibbling away the material with each pass, as shown in photo P.

**Shelving Dimensions**

Step 17 - Sand all the rails and legs through 220-grit sandpaper.

Step 18 - Cut the middle shelf (I) and the bottom shelf (H) to the dimensions given in the material list. Use the table saw to make the cuts, as shown in photo Q.

**Shelving Notch Layouts**

Step 19 - The shelves have notches cut out of their corners to fit around the legs. Dry-fit the rails and legs together, and measure around the inside corner of each leg to get the notches' dimensions. Transfer the dimensions to the shelves, as shown in photo R.

**Jig Sawing**

Step 20 - Use a hand-held jig saw to remove the notches in the shelves, as shown in photo S.

Step 21 - The top rails; both long and short, receive a groove near their top inside edges. The groove is used with top mounting clips (N) to fasten the top to the frame. Use

**Groove For Mounting Clips**

the table saw with a stacked dado blade to make the 1/4"-wide by 1/4"-deep groove 1/2" down from the top edge, as shown in photo T.

Step 22 - Cut the upper drawer guides (M) to the dimensions given in the material list. These guides connect to the front and back

**Making Biscuit Slots**

top long rails with #10 biscuits (S). Refer to the front view drawing and exploded view drawing for their locations. Mark the biscuit slot locations in each piece, and use the biscuit joiner to make the #10 slots, as shown in photo U and U inset.

**Top Dimensions**

Step 23 - Cut the top (J) to the dimensions given in the material list. Cut the top's length about 1" longer than what's given in the material list. Use the radial arm saw to cross cut the pieces and the table saw to make the ripped cuts, as shown in photo V.

**Top Glue-Up**

Step 24 - Glue and clamp the top pieces with their side grain face up, as shown in photo W.



Center Divider Notches

Step 25 - Cut the drawer divider (K) to the dimensions given in the material list. The divider is notched to fit around the top front and back long rails. The notches measure $\frac{3}{4}$ "-wide by 2"-long. Transfer each notch to the divider's top edge, as shown in photo X. Remove the material using the hand-held jig saw.



Mounting Clips

Step 26 - Cut the side drawer guides (L) to the dimensions given in the material list.

Step 27 - Cut the top mounting clips (N) to the dimensions given in the material list. The clips are made with a $\frac{1}{4}$ "-wide by $\frac{1}{4}$ "-long tenon. Use the router in the router table with the fence to make the rabbet in a piece of stock long enough to make the 6 clips, as shown in photo Y. The clips



Drawer Front Rabbets

are pre-drilled and countersunk in their centers for the wood screws (BB), as shown in photo Y inset.

Step 28 - Cut the drawer fronts (O), the drawer sides (P), and the drawer bottoms (Q) to the dimensions given in the material list. The drawer fronts receive a $\frac{1}{2}$ "-wide by $\frac{3}{8}$ "-deep rabbet on both their inside ends. Use the table saw with a $\frac{1}{2}$ " stacked dado



Drawer Side Grooves

blade raised to a height of $\frac{3}{8}$ ". Use a miter gauge to keep the fronts square as you run them over the blade, as shown in photo Z.

Step 29 - The drawer sides' inside surface's receive a groove along their bottom edges to house the bottom. Make the $\frac{1}{4}$ "-wide by $\frac{1}{4}$ "-deep groove with the table saw and a



Drawer Front Grooves

$\frac{1}{4}$ " stacked dado blade. The grooves start $\frac{1}{4}$ " up from their bottom edges, as shown in photo AA.

Step 30 - The drawer front's inside surface receives the same groove along its bottom edge, except it's $\frac{3}{8}$ "-deep, as shown in photo BB. Sand all the drawer parts through 220-grit sandpaper.



Top Edges Rounding Over

Step 31 - Sand the top through 220-grit sandpaper. Cut the top down to its final length of 36". Use a round-over bit in the router to ease the edges of the top. Both top and bottom edges get rounded over, as shown in photo CC.

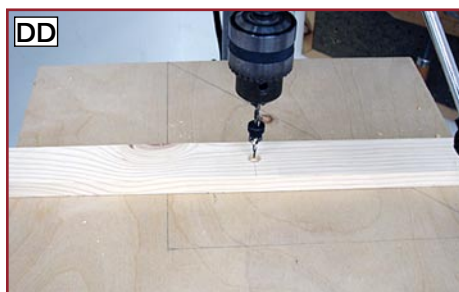

Top Rails Button Locations

Step 32 - The center drawer divider is held in place with two wood screws (T) through the top long front and back rails and three wood screws (T) centered and evenly spaced through the middle shelf. Locate the center on the long rails, and drill a $\frac{1}{2}$ " countersunk hole 1" down from the top



Middle Shelf Screw Locations

edge. Countersink to a depth to hold a $\frac{1}{2}$ " maple button (U), as shown in photo DD. **Step 33** - Drill 3 evenly spaced countersunk screw holes in the center of the middle shelf's bottom side. Only countersink to a depth to allow the screw head to sit flush with the wood, as shown in photo EE.



Partial Glue-Up

Step 34 - Assemble the project frame in two halves. Clamp and glue two legs with the top long rail, middle long rail, and bottom long rail. The groove in the top rail and the rabbets in the middle and bottom rails face toward the top, as shown in photo FF. Check for square.

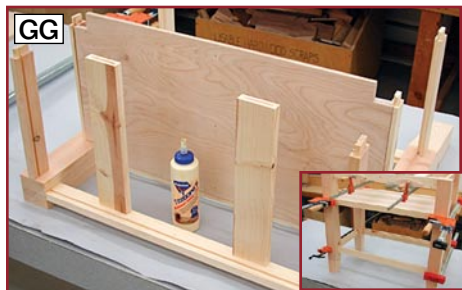
Frame Assembly

Step 35 - Once the two halves have dried, keep one set of legs flat against the table. Glue in place the short rails and upper drawer guides with biscuits in one half of the leg assembly. Place the middle shelf in position now, as shown in photo GG. Glue the other leg assembly onto the short rails and upper drawer guides with biscuits.

Dry-Fitting Drawers

Clamp the entire frame assembly together and check for square, as shown in photo GG inset.

Step 36 - Dry-fit the drawers together. Place the center divider into its final position. Slide the drawers in the openings. Check that the clearance is enough side to

Fastening Middle Shelf

side and up and down, as shown in photo HH. Make any necessary adjustments if the drawers don't move freely.

Step 37 - Remove the drawers and fasten the middle shelf to the top rails with $\frac{3}{4}$ "

Hardware Pre-Drilling

brads (V), as shown in photo II. Cover the nail heads with wood filler (W). Sand the wood filler flush when dry.

Step 38 - Pre-drill in the center of the drawer fronts the screws that will hold your

Drawer Assembly

hardware in place, as shown in photo JJ.

Step 39 - Assemble the drawers together with some wood glue in the rabbets and $\frac{3}{4}$ " brads (V), as shown in photo KK.

Mounting Clips Screw Locations

Step 40 - Place the top, with the top side down, and center the frame assembly on the top. Place the top mounting clips into position evenly spread around the top. Mark the clip screw locations with an awl



Pre-Drilling

through the screw holes in the clips, as shown in photo LL.

Step 41 - Remove the frame assembly and pre-drill into the top for the $1\frac{5}{8}$ " mounting clip wood screws (BB), as shown in photo MM.

Tape Off and Paint

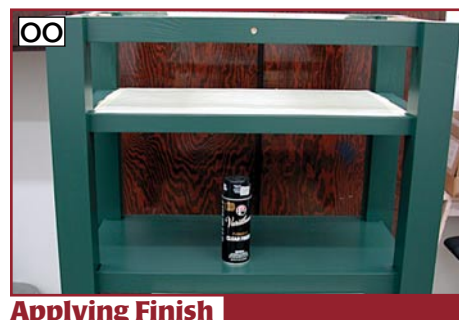
Step 42 - The entire project is painted except the top, drawers, drawer divider, upper drawer guides, side drawer guides and maple buttons. Paint the project a color of your choice, or use the color we used (X), as shown in photo NN. The middle shelf's

Applying Finish

top surface is not painted between the two side drawer guides and the front and back long rails. Use some tape to prevent from painting on these areas.



Side Drawer Guides

Step 43 - Finish the painted portion of the project with a few coats of the spray finish (CC), as shown in photo OO.

Step 44 - Remove the tape from the middle shelf. Glue and clamp in place the side drawer guides so that their inside edges are flush with the inside edges of the legs, as shown in photo PP.

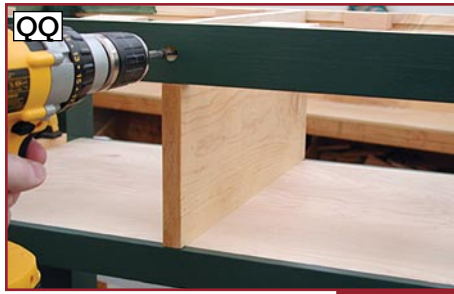

Fastening Center Divider

Step 45 - Center and attach the center divider with the wood screws (T) from under the middle shelf and through the long front and back rails, as shown in photo QQ.

Step 46 - Place the frame assembly back onto the top, and fasten the top to the frame through the mounting clips with the wood screws (BB), as shown in photo RR.



Attaching Top and Wheels

Step 47 - Attach the wheels (DD) with four screws centered on the bottom of each leg, as shown in photo RR inset.

Step 48 - Apply a coat of butcher block oil (Y) to the top. Add a few coats of Watco oil (Z) to the center divider, drawer fronts, drawer sides on their outside surfaces only, and the maple buttons. Attach hardware (AA) to the drawer fronts. **WWW**

Exploded View

