

BUILD IT WITH
REDWOOD

Adirondack Swing



R E D W O O D

- Naturally beautiful
- Easy to use
- Practical and economical
- Durable and stable
- Resistant to decay and insects

Adirondack Swing

Enjoy the art of relaxation with this easy-to-build porch swing. Modeled after the classic Adirondack lawn chair, this two-person swing features rounded wooden slats and a comfortable slant-back design. This style swing is typically installed on a covered porch or gazebo. It can also be hung beneath a second-story deck or from a large tree branch.

To make certain the swing provides many years of enjoyment, build it with an all-heartwood grade of redwood: Deck Heart or Construction Heart. These grades provide maximum durability and are easy to work.

BUILD THE SWING FRAME

This redwood swing is built primarily of 1x4s and 1x6s; the front and rear uprights are cut from 2x4s for maximum strength. Start by assembling the frame of the swing to form the seat section. Attach the four 2x4 uprights, then begin installing the slats that form the back and seat of the swing.

Remember to cut and measure as you go, using the Materials List as a guide. Fasten together all the parts with corrosion-resistant stainless steel or hot-dipped galvanized screws. To prevent the screws from splitting the wood, predrill pilot holes first, especially at board ends. Counterbore all visible surface screw holes with a $\frac{3}{8}$ -inch-diameter spade bit to a depth of about $\frac{1}{4}$ inch. Then fill the holes with $\frac{3}{8}$ -inch-diameter redwood plugs, which you can make with a plug cutter.

1. Seat frame Start by making the front rail and lower back rail; cut two 1x4s to $47\frac{3}{8}$ inches long. Then cut the three 1x4 seat supports that connect the front rail to the lower back rail. Rough-cut these three crosspieces to 20 inches long.

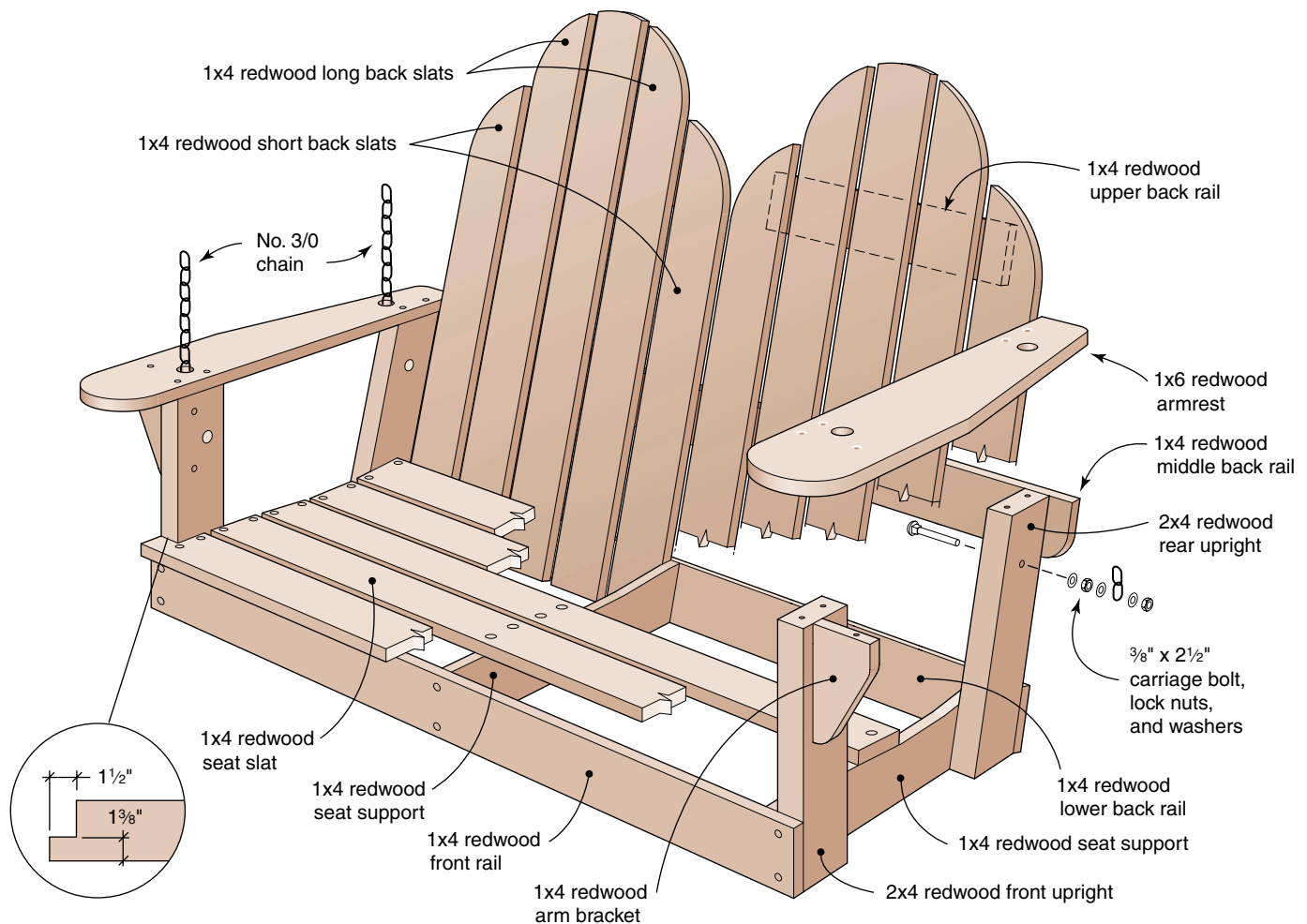

2. Seat supports The 1x4 seat supports are specially shaped to create the comfortable contoured seat and slanted back. Refer to the seat-support pattern (shown below) for specific details. Note that the back end of each seat support is miter-cut to a 15° angle and a portion of the upper edge is trimmed away to accommodate the five 1x4 seat slats.

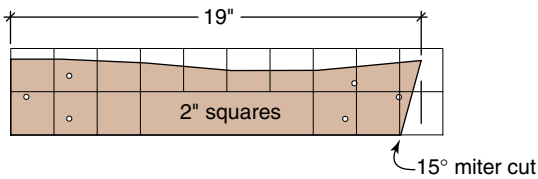

Here's how to make the seat supports: Take one of the 20-inch-long 1x4s and draw the grid of 2-inch squares onto its surface, as shown in the seat-support pattern. Then measure 19 inches from one end and mark the 15° cut. Next, using the pattern as a guide, mark the cut line through the squares in the grid. Cut along the segmented line with a sabre saw and lightly sand the edges smooth. Now, use this support as a template to mark the remaining two. That will ensure that all three supports will be identical.

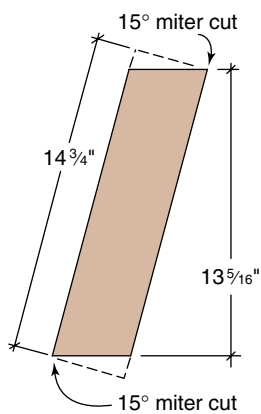

3. Uprights Cut the two front uprights from a 2x4, making sure that both ends of each board

are perfectly square. Then rough cut the two rear uprights to about 14 3/4 inches. Miter both ends of these 2x4 pieces to 15°. All of the uprights should finish at a height of 13 5/16 inches.

4. Assemble the frame Begin assembling the swing's frame by screwing the front rail to the two front uprights. Hold the vertical uprights flush with the ends of the front rail and attach each one with two 1 3/4-inch screws. Follow the same procedure to attach the lower back rail to the rear uprights.

Next, screw a 1x4 seat support to the inside surface of each front upright using 1 3/4-inch screws. Be sure the angled ends of the supports point toward the rear of the frame. Then, screw the back ends of the seat supports to the inside of the rear uprights. Now use 2 1/2-inch screws to install the remaining seat support in the middle of the frame by first screwing through the front rail and then through the lower back rail.

1. Back slats The doublewide back of the swing is made up of 10 redwood 1x4 slats, which are cut to resemble two side-by-side Adirondack chairs. Cut the six center slats to 36 inches long and the four end ones to 30 inches. Also, cut to length the two upper back rails and the middle back rail. These three 1x4 rails get screwed across the rear of the slats. Bevel cut the upper edge of the middle back rail to 15° to support the swing's armrests at the back. Round off the bottom corners of the rail with a 1 3/4-inch radius.

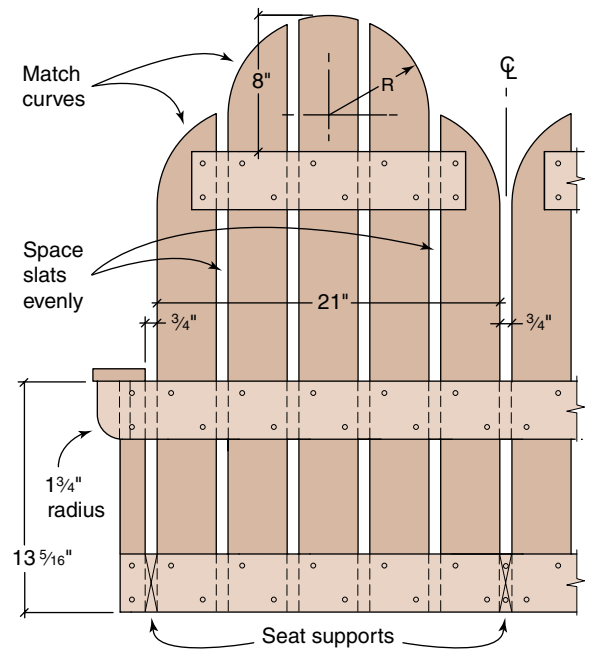

Arrange five back slats—one “chair” back—on a flat surface and space them equally. Secure or weight the slats to keep them aligned and square. Find and mark the centerline of the radius for the curved ends of the center three, or longer, slats. Use a compass or pencil and string to scribe or mark the radius lines for cutting. Use the curved slats as templates for cutting the curves in all the remaining back slats, including the four shorter side slats. Sand the edges smooth with 120-grit sandpaper.

2. Assemble the swing back Now, lay all ten back slats face down on a clean surface, in order and spaced equally. Again, secure or weight them as before to keep them aligned and square. Leave at least a 3/4-inch space between the chair backs to accommodate the center seat support later

If you choose to counterbore the screws for the following three back rail attachments, you must use screws that are at least 1/4 inch shorter than indicated here.

Measure down 8 inches from the top of the center slats and attach the upper back rails. Drive two 1 $\frac{1}{4}$ -inch screws through the rails and into each slat; be careful not to overdrive the screws or their sharp points will poke through the other side.

The middle back rail attaches 13 $\frac{5}{16}$ inches up from the bottom ends of the slats, with its beveled edge facing toward the top of the slats. The rail should extend beyond the slats an equal amount at each end. Use 1 $\frac{1}{4}$ -inch screws.

3. Install the swing back Set the assembled swing back into the frame. Slip it between the rear uprights and push it back against the lower back rail. The bottom ends of the slats should be flush with the bottom edge of the lower back rail. Secure the back by driving two 2 $\frac{1}{2}$ -inch screws through the ends of the middle back rail and into the rear uprights. Check to make certain the ends of the middle rail are even with the tops of the uprights. Now, switch back to 1 $\frac{1}{4}$ -inch screws and fasten the bottom ends of the slats to the lower back rail. Again, predrill pilot holes, if necessary, to prevent the screws from splitting the slats.

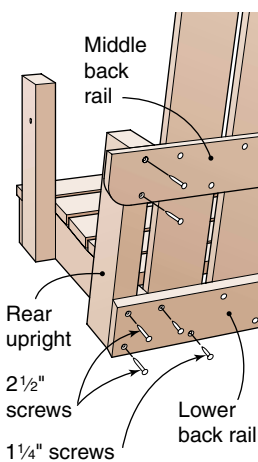

4. Armrests Cut the two 27 $\frac{1}{2}$ -inch-long armrests from a redwood 1x6. Refer to the armrest detail illustration, which shows how they taper to only 3 inches wide at the back end. Cut the large, rounded front ends with a sabre saw and sand them smooth with 120-grit sandpaper. For a little added comfort, ease the top edges of the armrests using a router fitted with a $\frac{1}{4}$ -inch roundover bit, or an orbital finishing sander and 100-grit sandpaper.

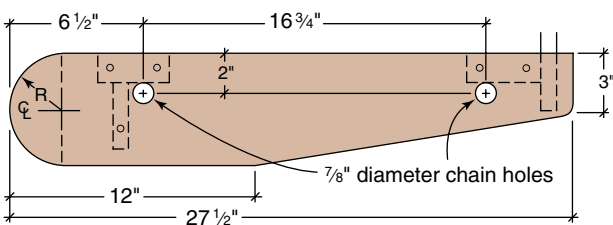

Cut the two short arm brackets from a 1x4. Hold them flush with the tops of the front uprights and attach them by driving two 2 $\frac{1}{2}$ -inch screws through from the inside of the 2x4 uprights.

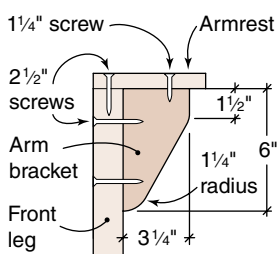

ASSEMBLE THE SWING

Set each armrest in position on the frame, with its wide front end on top of the front upright and its narrow back end on the rear upright. Attach each armrest with four 2½-inch screws, driven into the uprights. Use one 1¼-inch screw to attach the armrest to the arm bracket.

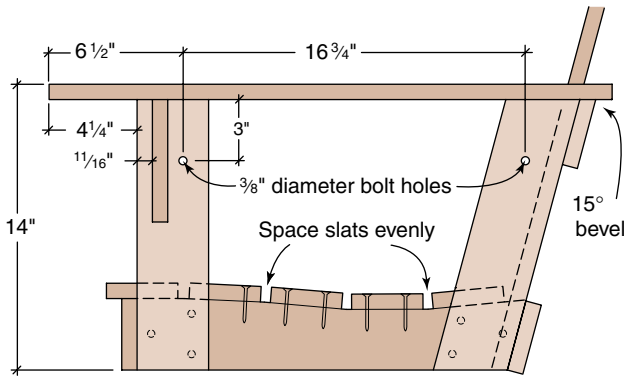

5. Seat slats Next, cut five 1x4 slats for the seat of the swing. Note that the front seat slat is 3 inches longer than the other four slats because it wraps around the front uprights. Cut a 1½ by 2½-inch notch into both ends of the front seat slat to allow it to fit around the 2x4 uprights (see illustration). Again, use the router and roundover bit or orbital sander, if desired, to soften the top edge of the front seat slat. Screw the front seat slat to the three seat supports using 2½-inch screws.

6. Install the seat slats Set the remaining four seat slats onto the frame and space them equally. Check to make sure both ends of each slat is flush with the outside of the seat supports. Secure each slat with six 1¼-inch screws. There should be a minimum of a ⅜-inch space between the last seat slat and the slats of the back. This space will allow rain and debris to wash through to the ground and to not collect on the seat.

7. Apply a finish Redwood accepts a wide variety of wood finishes. Regardless of which one you choose, be sure it's an exterior-grade finish. Begin by sanding the wood smooth either by hand or with an orbital finishing sander. Start with 100-grit sandpaper and sand all surfaces. If you're sanding by hand, be certain to sand with, not across, the wood grain. Sweep the chair clean of all dust and grit and then switch to 120-grit sandpaper for the final sanding.

Refer to the Finishes section on the back of this brochure for various recommended finish options and their effects.

Do not apply a clear topcoat finish, such as varnish. It will eventually crack and blister, leaving you no option but to sand or strip off the old finish.

8. Add the chains As mentioned earlier, the swing is suspended from four chains that are bolted to the 2x4 uprights. To attach the chains, start by boring two 7/8-inch-diameter chain holes through each armrest, as shown in the armrest detail illustration (shown previously). Next, bore a 3/8-inch-diameter bolt hole through each upright. Locate these holes three inches directly below the chain holes in the armrests.

To hang the swing from a standard 8-foot-high ceiling, you'll need four 6-foot lengths of No. 3/0 steel chain. Have the chain cut to length at the hardware store.

In each bolt hole, insert a 3/8-inch-diameter by 2½-inch carriage bolt. Tighten each bolt with a washer and locknut. Then, pass a length of chain through the hole in the armrest and slip the first link over the end of the bolt. Add another washer and locknut to secure the chain. Repeat this procedure for the remaining three chains.

9. Hang the swing The seat of the swing should be suspended about 20 to 22 inches above the porch floor. However, to avoid serious injury, it's very important that you bolt the chains to solid framing members, such as a ceiling joist or roof rafter. Never hang the swing by screwing into plywood sheathing or thin ceiling planks.

For the strongest connection, bore a hole through the middle of the framing member and attach the chains with carriage bolts or threaded eyebolts. Another option is to bore pilot holes into the bottom edge of the framing members and attach the chains with long lag screws or eye screws.

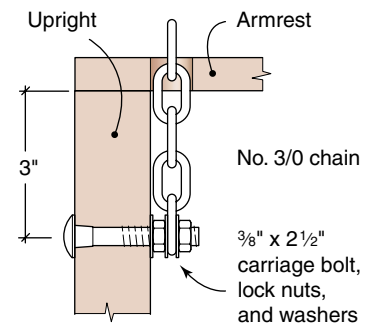

Tools you will need Tape measure, combination square, cordless drill/driver or electric drill, power miter saw or hand saw, sabre saw with adjustable baseplate, assorted twist-drill bits, counter-sink bit, adjustable wrench, 3/8- and 7/8-inch-diameter spade bits, hammer, orbital sander or sanding block, 100- and 120-grit sandpaper, 3/8-inch-diameter plug cutter and pencil compass. Optional: router with 1/4-inch-radius roundover bit.

Materials For Adirondack Swing

	Quantity	Size	Length
Framing			
Front uprights	2	2x4	13 ⁵ / ₁₆ inches
Rear uprights	2	2x4	14 ³ / ₄ inches
Seat supports	3	2x4	19 inches
Front rail	1	1x4	47 ³ / ₈ inches
Back			
Lower back rail	1	1x4	47 ³ / ₈ inches
Middle back rail	1	1x4	50 inches
Upper back rails	2	1x4	16 ¹ / ₂ inches
Back slats	6	1x4	36 inches
Back slats	4	1x4	30 inches
Arms			
Arm brackets	2	1x3 ¹ / ₄	6 inches
Armrests	2	1x6	27 ¹ / ₂ inches
Seat			
Front seat slat	1	1x4	47 ³ / ₈ inches
Seat slats	4	1x4	44 ³ / ₈
Chain	4	No. 3/0	6 feet
Carriage bolt, lock nuts (2) and washers (3)	4 sets	³ / ₈ inch	2 ¹ / ₂ inches
Deck screws	1 ¹ / ₂ pounds	1 ¹ / ₄ inches	
	1 pound	1 ³ / ₄ inches	
	1 pound	2 ¹ / ₂ inches	
Sandpaper	as needed	100, 120 grit	

Contact the California Redwood Association for more great publications containing redwood technical and building information. Call us toll free at 1-888-Cal-Redwood for a complete literature list or to ask for any of the titles listed here:

<i>Other Construction Tipsheets</i>	<i>Also Available</i>
Deck Over Concrete	Deck Construction
Freestanding Deck	Deck Grades, Nails and Finishes
Calistoga Spa Surround	Fences for All Reasons
Windsor Shade Shelter	Landscape Architecture
Monterey Potting Center	
Mendocino Bench	
Lake Tahoe Gazebo	
Petaluma Planters	
Sonoma Picnic Table	
Adirondack Chair	

Redwood

For beauty and performance, redwood is naturally superior to other woods. That's why it's the first choice for decks, fences and most outdoor projects. Redwood retains its beauty outdoors, shrinks and swells less than other woods and is less likely to warp, split, check or cup. With relatively little or no pitch, redwood is easy to drill, saw and shape. Redwood heartwood has natural durability and resistance to insects and will last longer outdoors than most woods.

Grades

The knotty garden grades of redwood are ideal for outdoor projects. These grades are beautiful, durable and economical.

Construction Heart/Deck Heart is all heartwood and contains knots; used for load-bearing applications near the ground. Deck Heart is graded for strength and is available in 2x4 and 2x6.

Construction Common/Deck Common contains sapwood and knots; used for decking and above-ground uses. Deck Common is graded for strength and is available in 2x4 and 2x6.

Merchantable Heart is all heartwood and contains larger knots than Construction grades; used near the soil.

Merchantable contains sapwood and larger knots; used for fence boards, rails and above-ground uses.

Finishes

Redwood accepts finishes better than most woods. Some heighten redwood's natural beauty, bringing out the color and the grain. Others help the wood harmonize or contrast with surrounding structures. Read the labels on all finish products before using.

No-finish option Redwood performs better than most woods if left unfinished. This no-maintenance option will result in redwood weather-bleaching to a soft driftwood gray.

Clear water repellent finish is recommended to stabilize the color at tan.

Semitransparent stains in "redwood" shades tint the wood without hiding the grain.

Solid-color stains or paints should be applied over compatible oil-based primers.

Fasteners

Use only non-corrosive hardware such as aluminum, stainless steel or top quality hot-dipped galvanized screws or nails. Ordinary nails and screws will cause stains.



405 Enfrente Drive, Suite 200
Novato, CA 94949-7206
Telephone 415 382-0662
Toll Free 888 Cal-Redwood
Fax 415 382-8531
www.calredwood.org