

**Craftsman  
Tall Shelf Clock  
Number 1**

---

# Directional Views of Clock

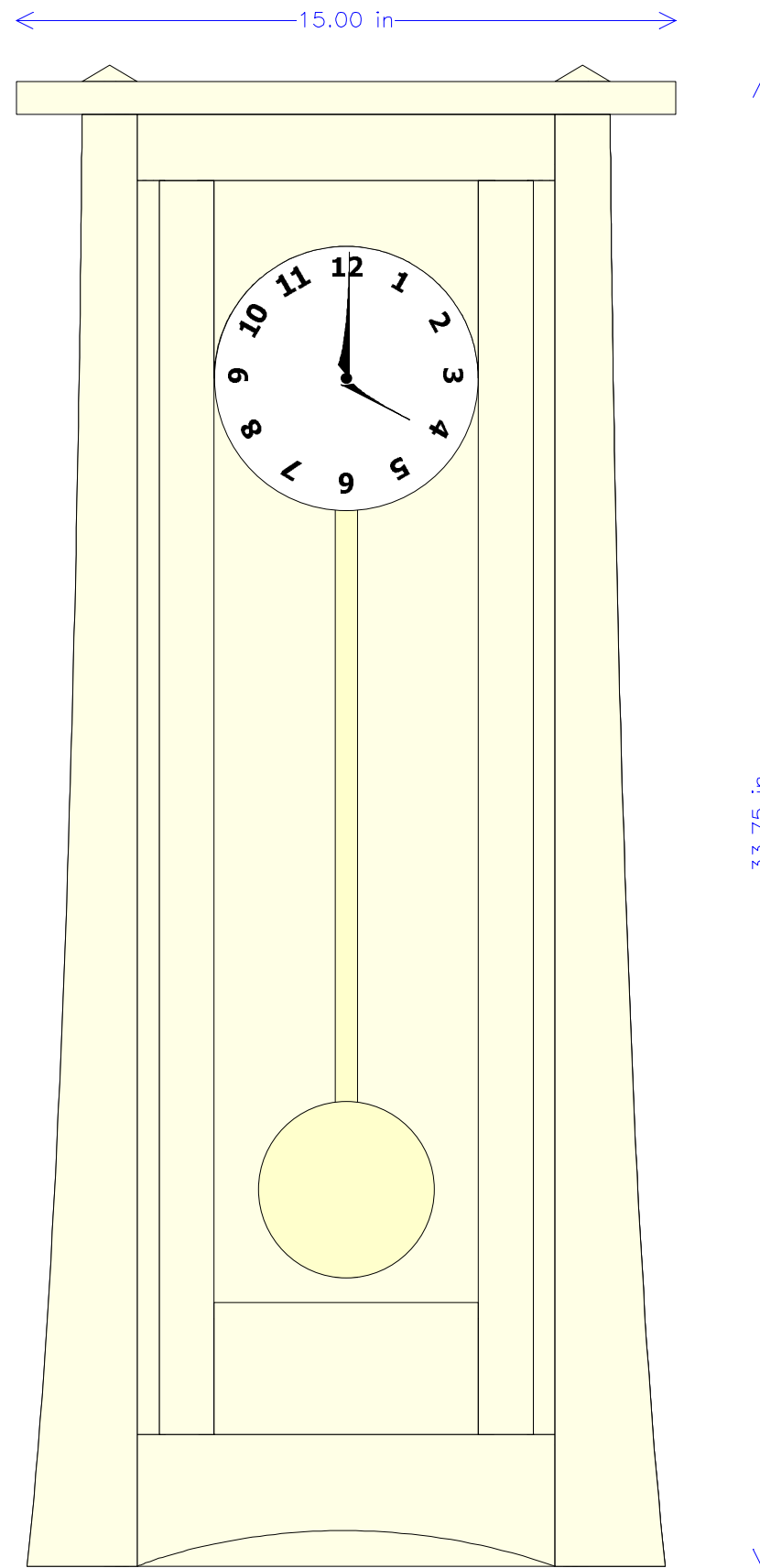

**Front View**

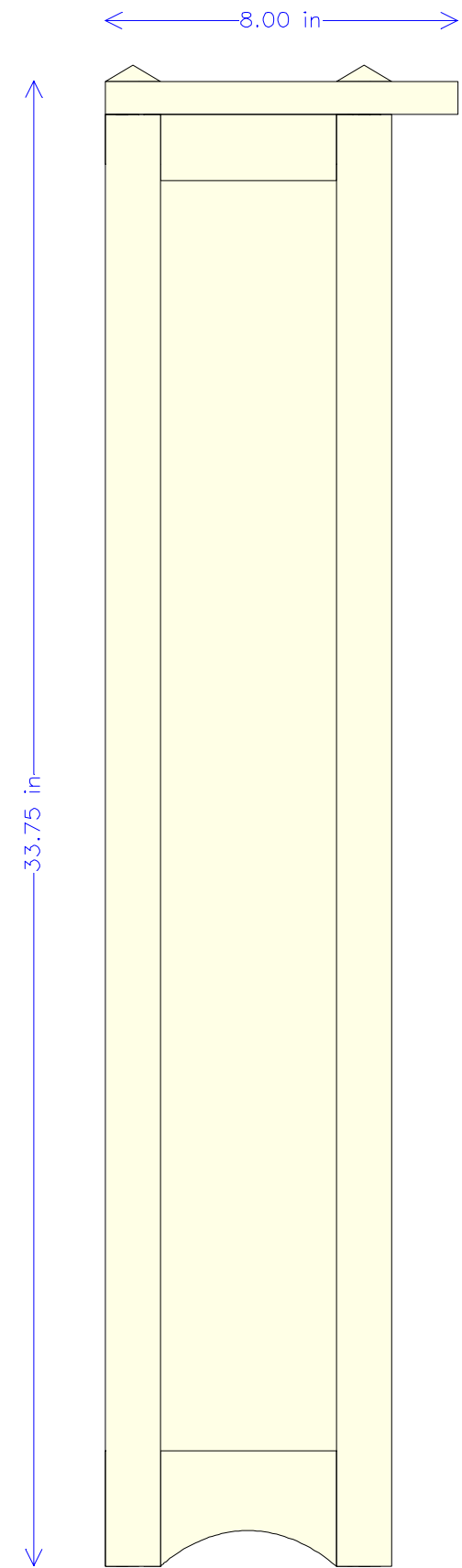

**Side View**

## Rear Leg (2 Each - Reversed)

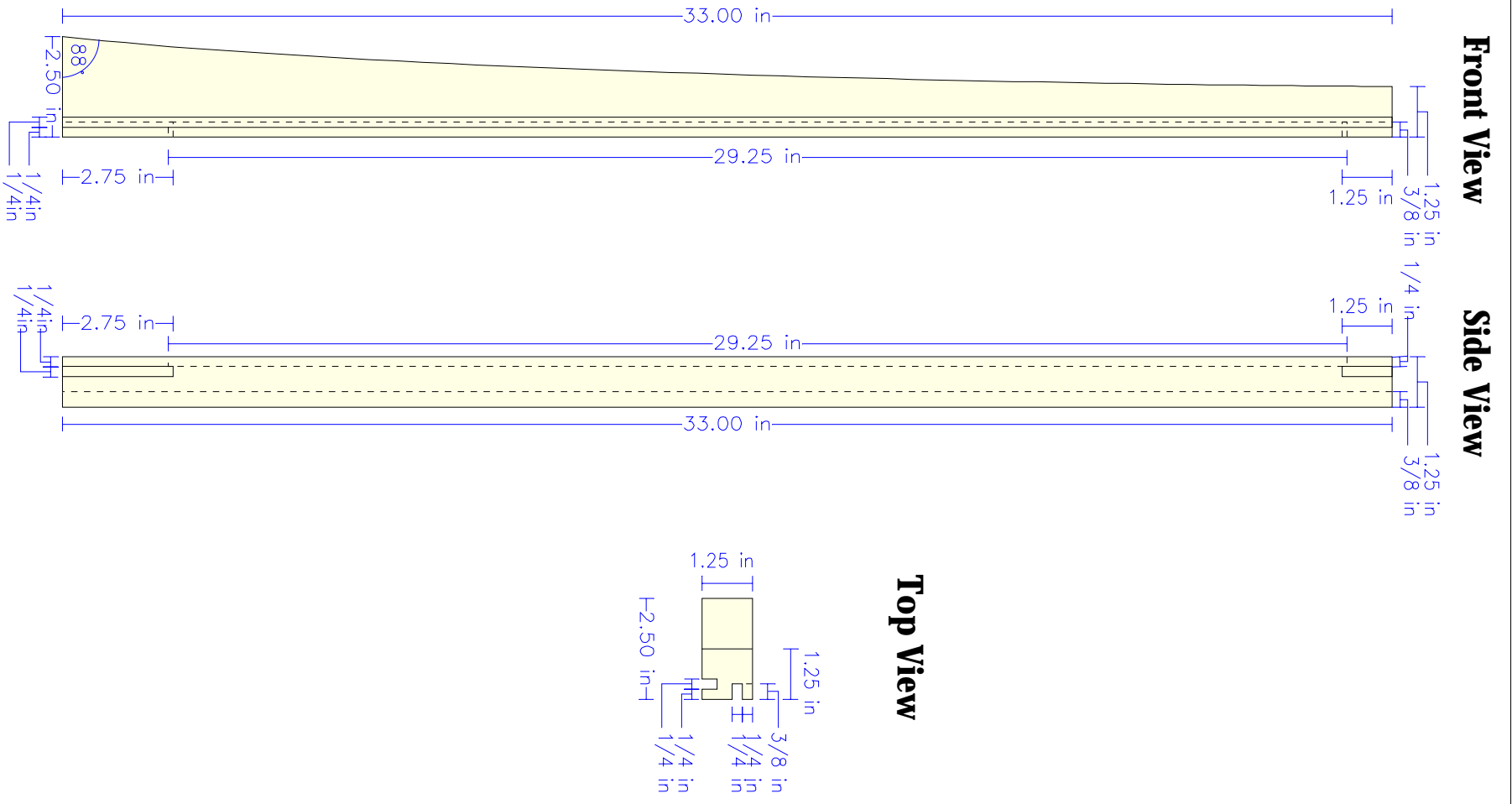

## Front Leg (2 Each - Reversed)

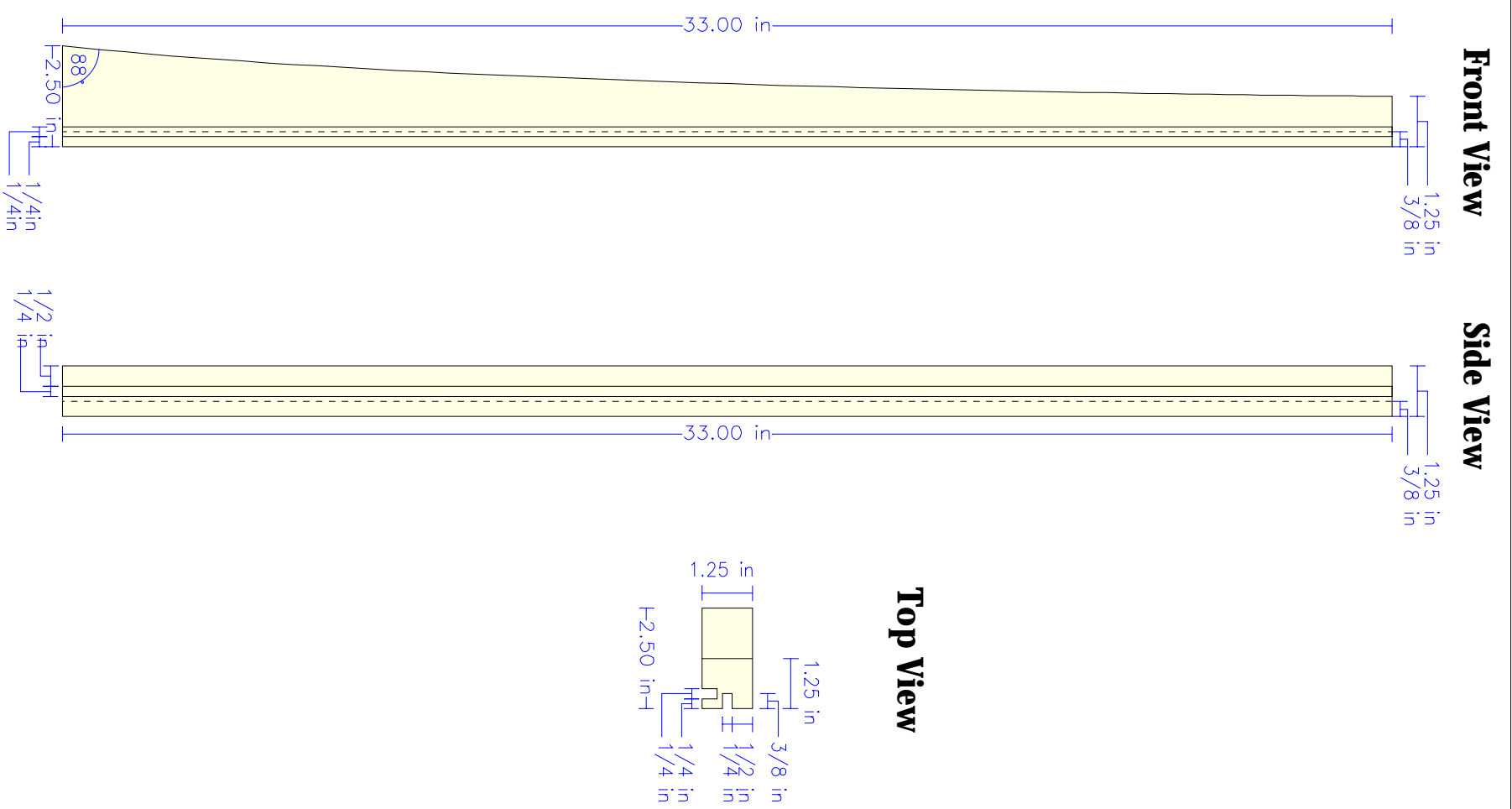

## Top Side Stile ( 2 Each )

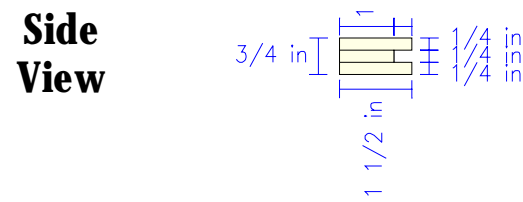
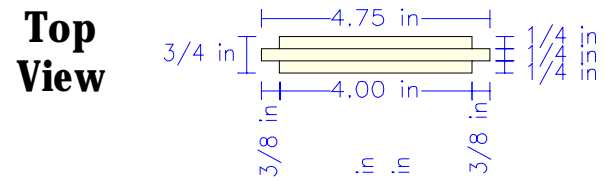
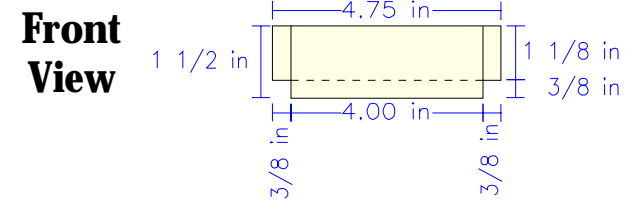

## Top Rear Stile

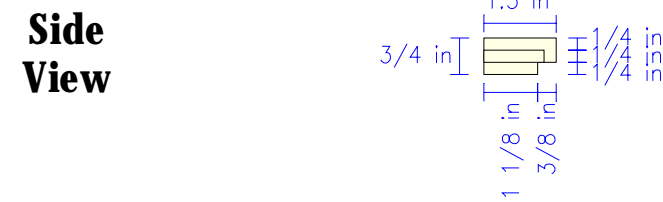
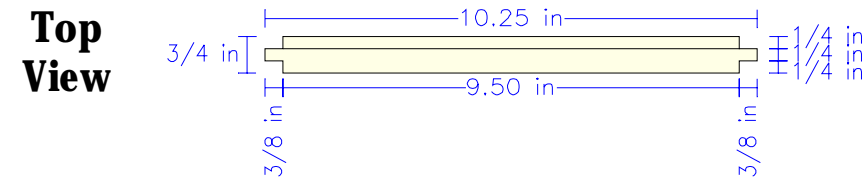
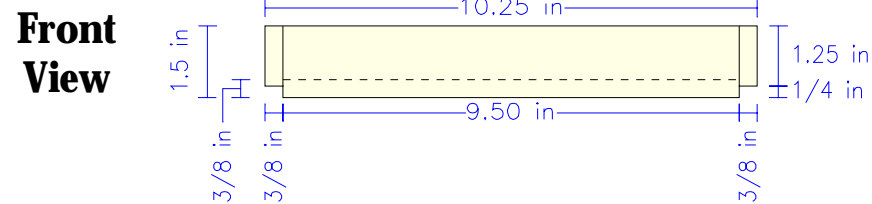

## Top Front Stile

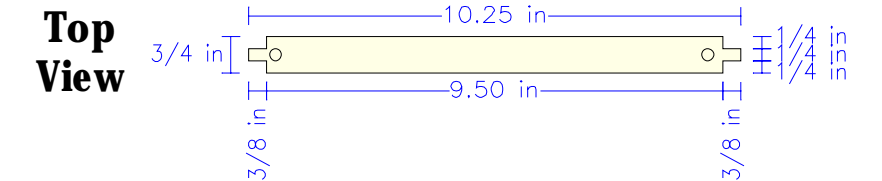
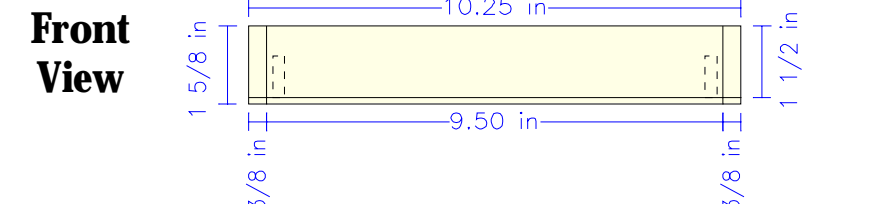

## Bottom Side Stile ( 2 Each )

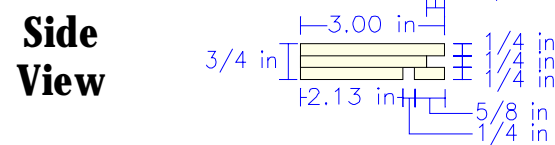
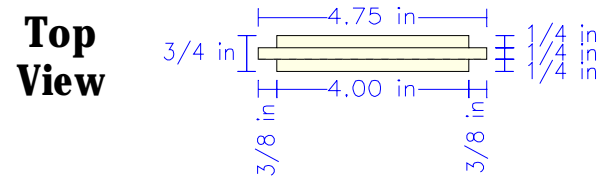
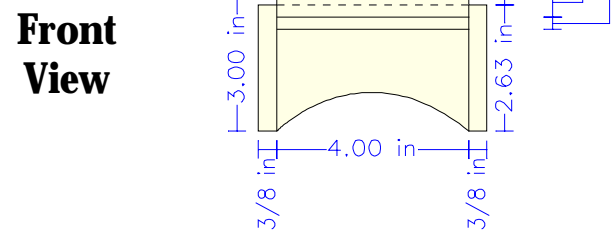

## Bottom Rear Stile

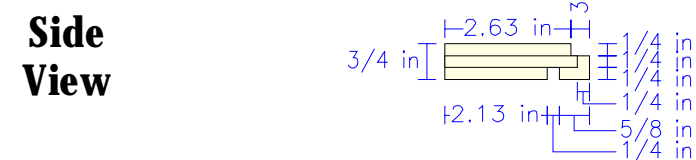
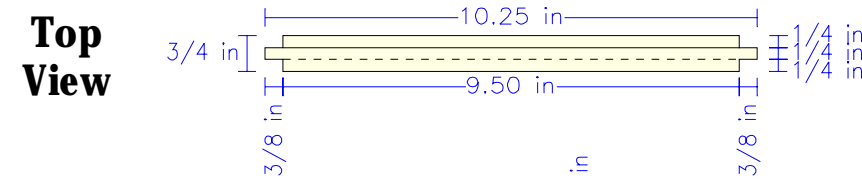
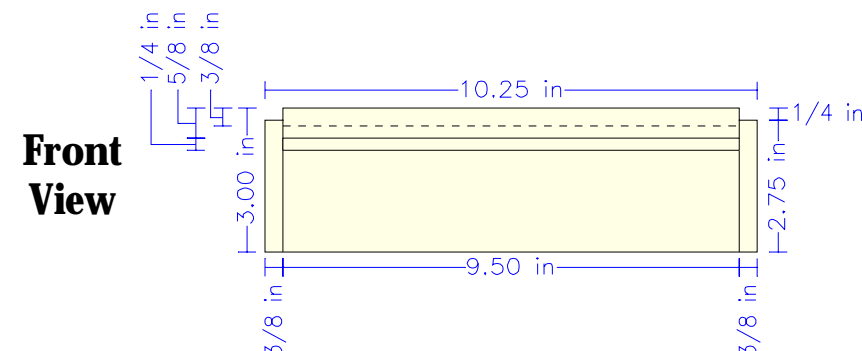

## Bottom Front Stile

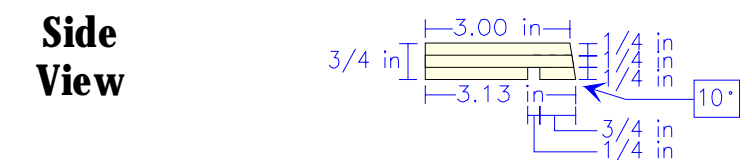
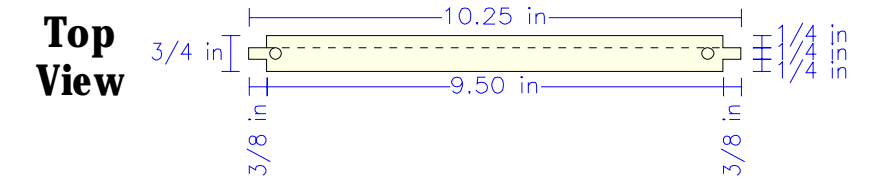
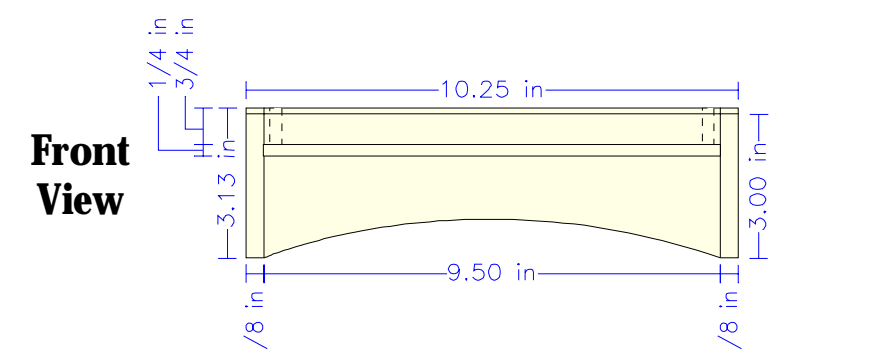

## Top Door Stile

**Front View**

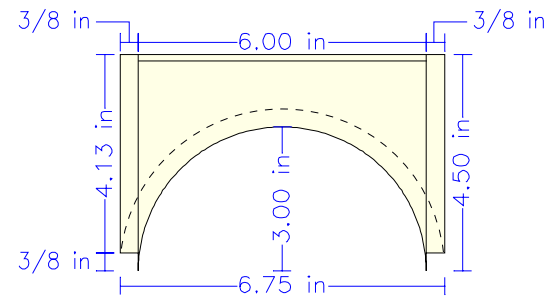

**Top View**

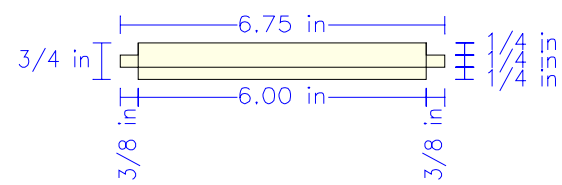

**Side View**

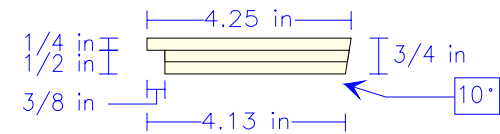

## Side Panel (2 Each)

**Front View**

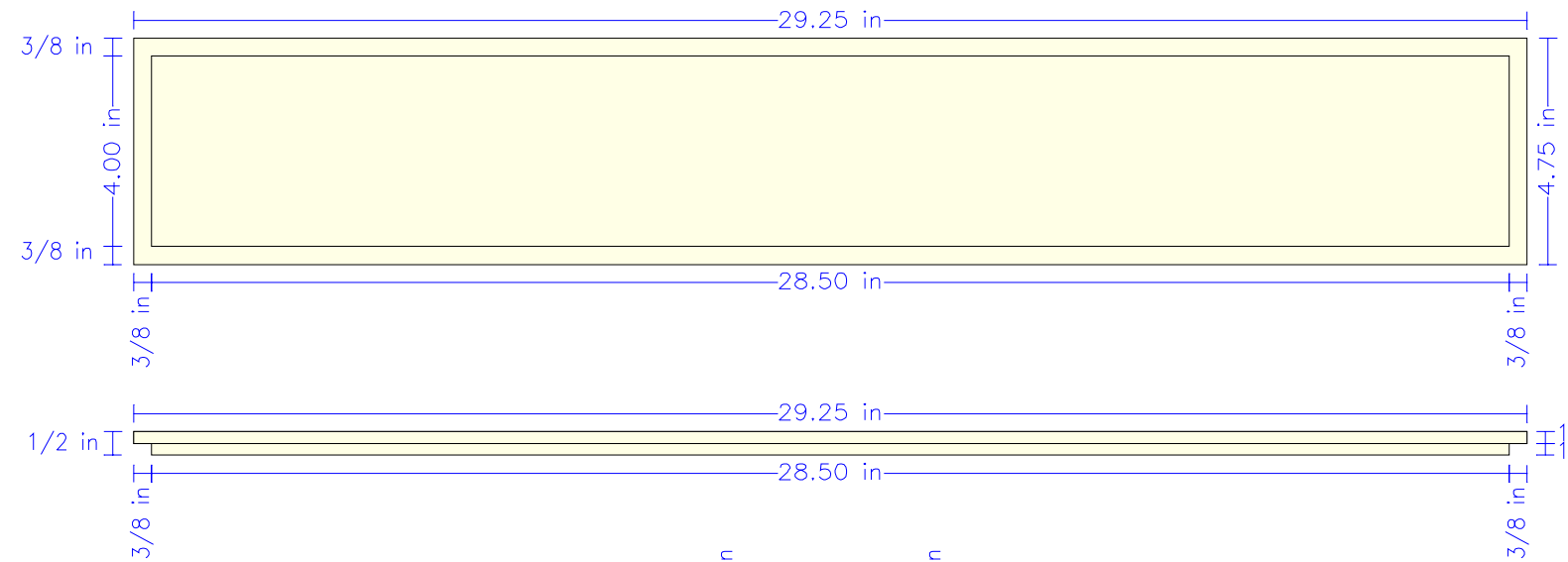

**Side View**

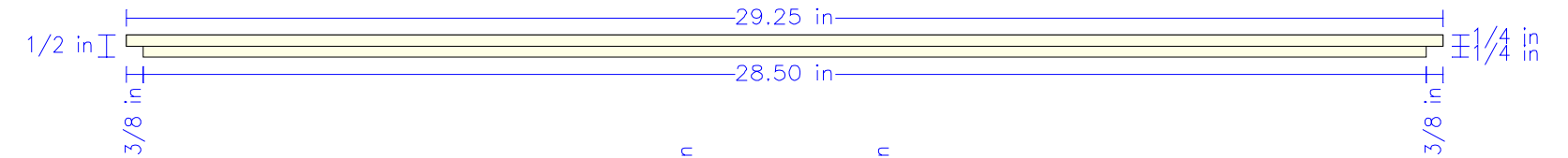

**Top View**

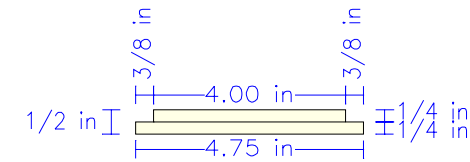

## Bottom Door Stile

**Front View**

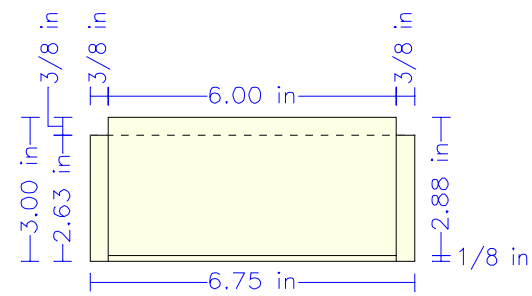

**Top View**

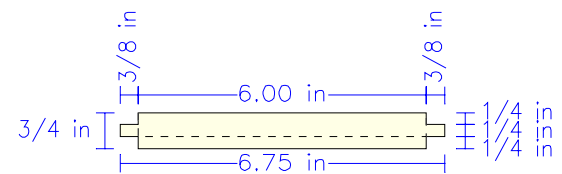

**Side View**

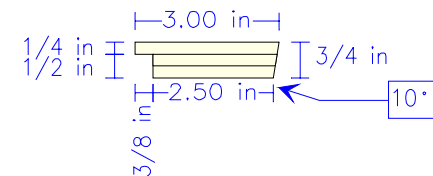

## Door Rail (2 Each)

**Front View**

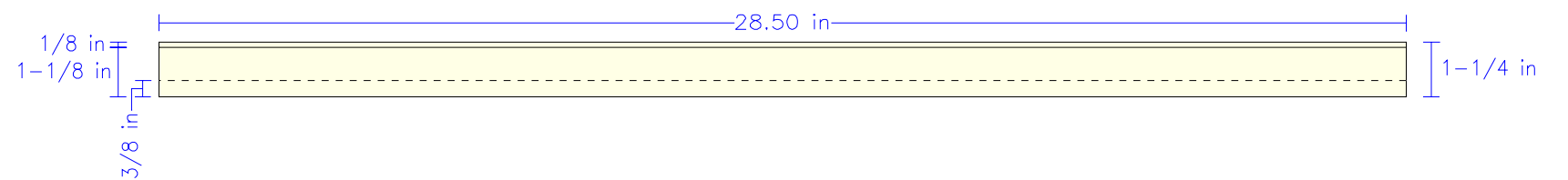

**Side View**

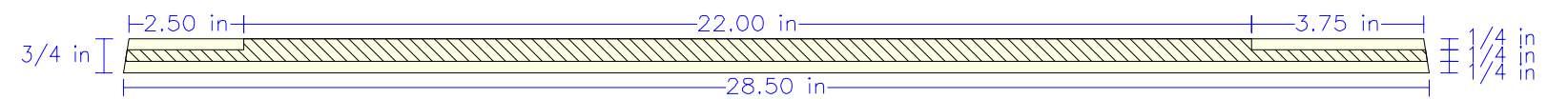

**Top View**

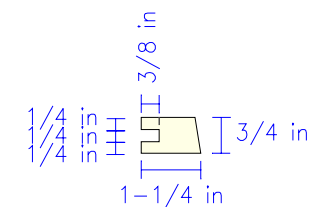

## Bottom Panel

**Top View**

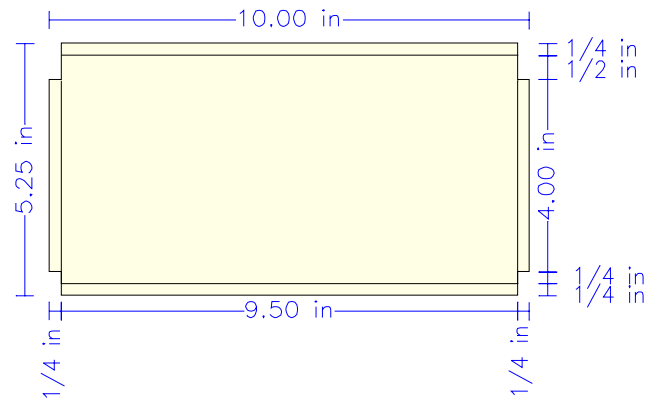

**Front View**

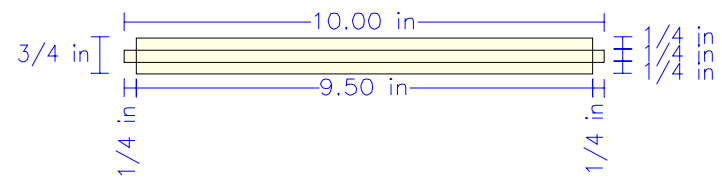

**Side View**

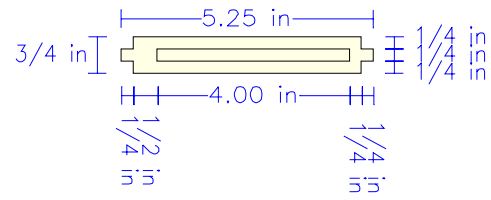

## Clock Top

**Top View**

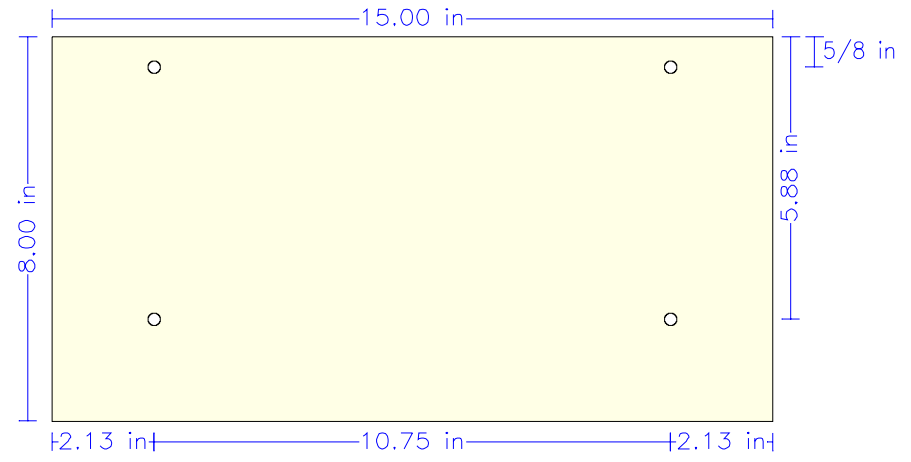

**Front View**

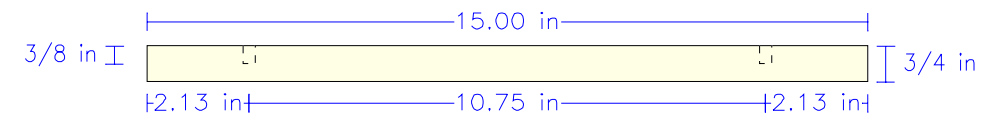

**Side View**

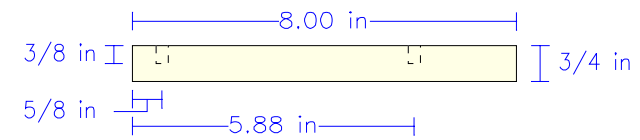

## 1/4 Inch Back Panel

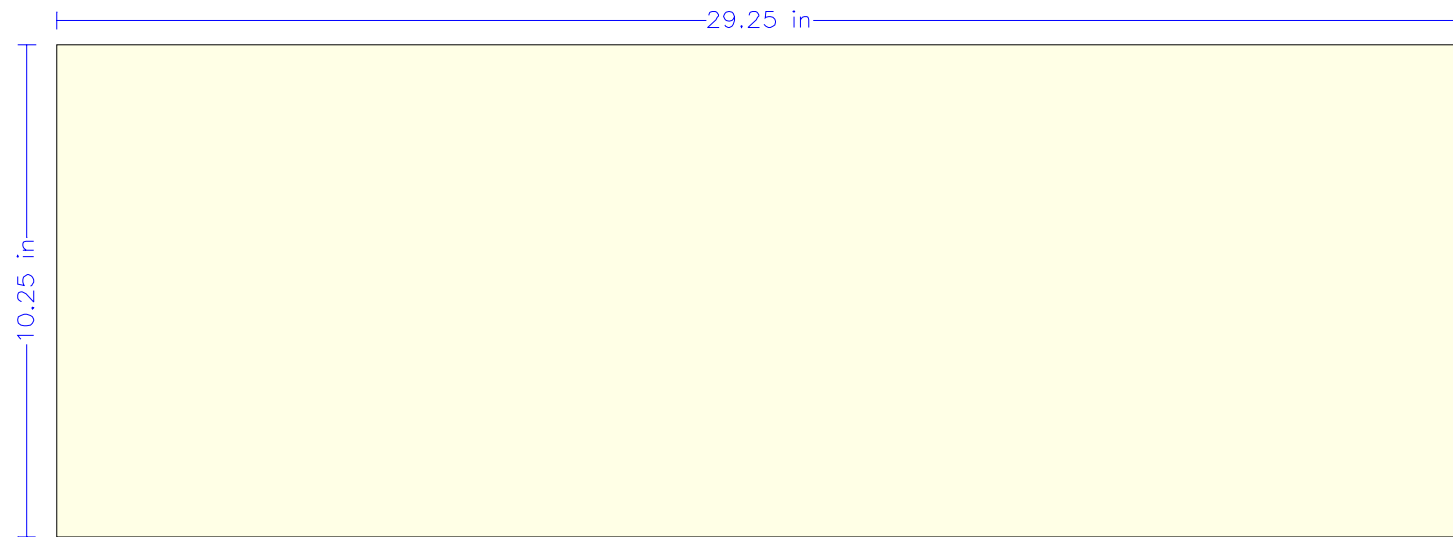

## Finial (4 Each)

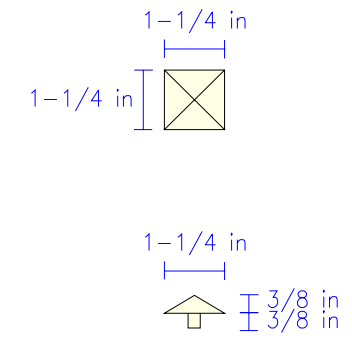

## Front Rail (2 Each)

**Front View**

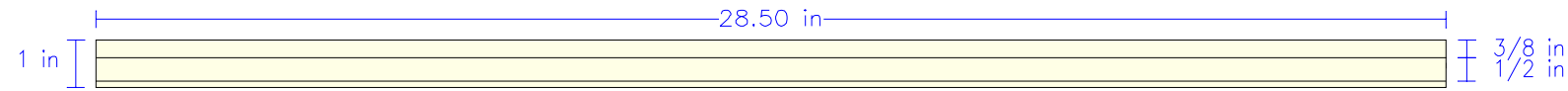

**Side View**

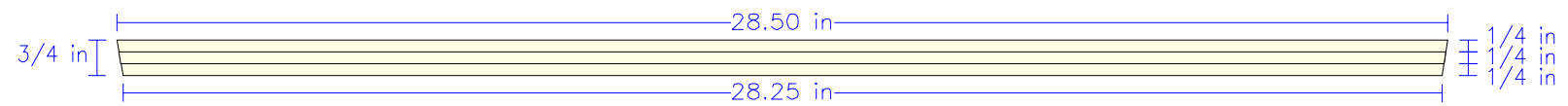

**Top View**

