

**Craftsman
Lounge Chair
Number 1**

Directional Views of Chair

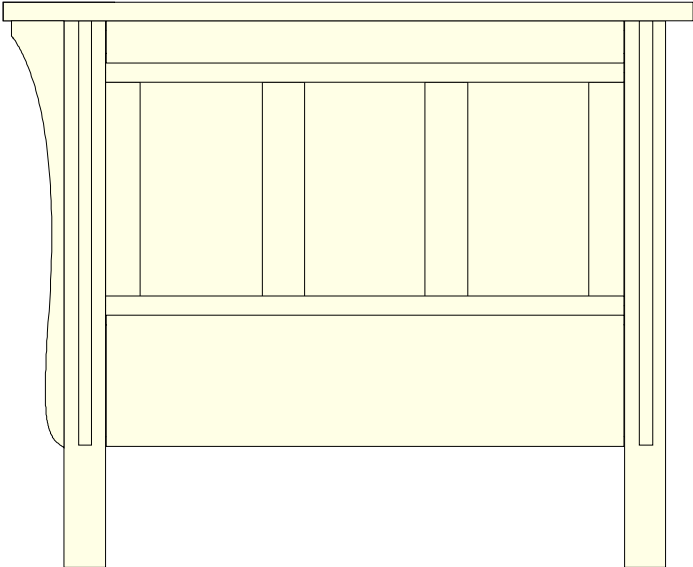

Side View

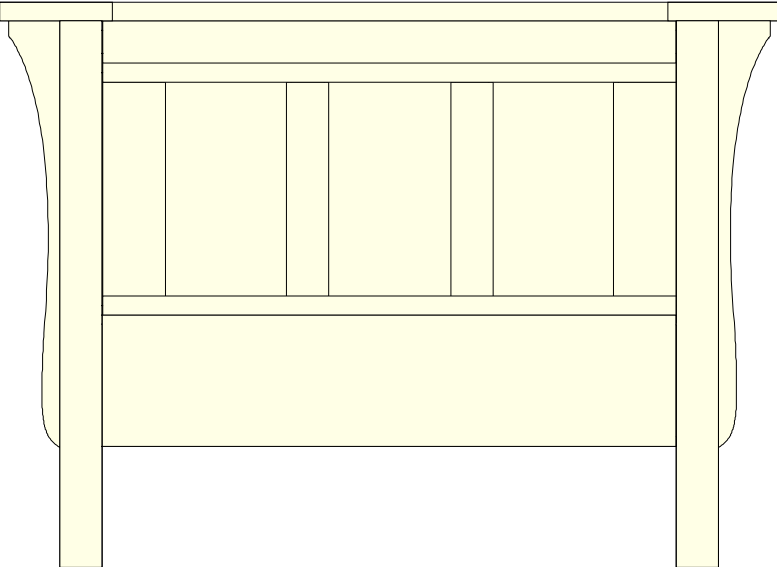

Front View

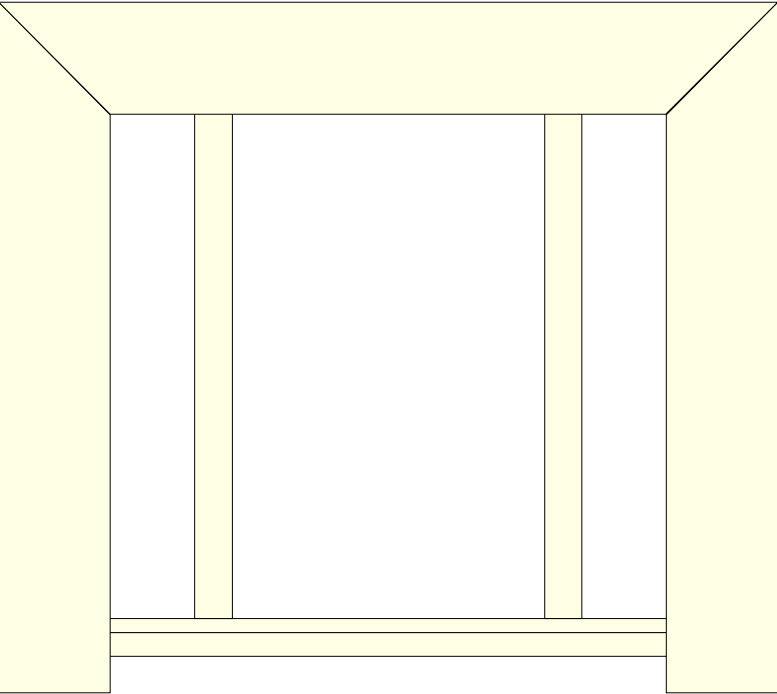

Top View

Exploded View of Chair Back

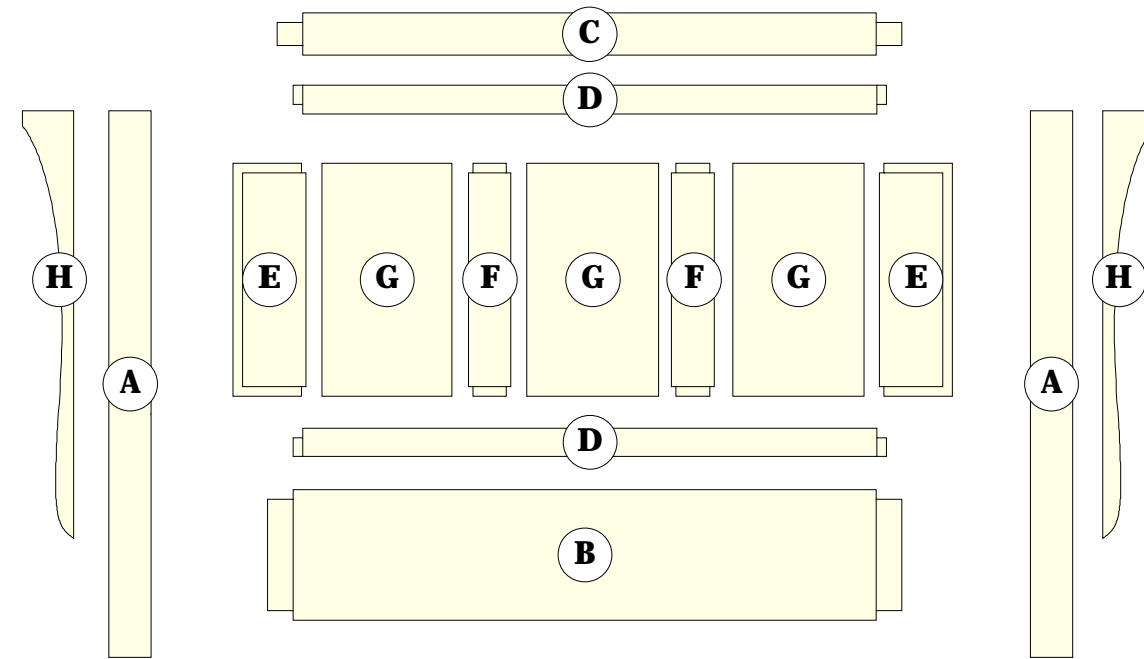

- A) Leg**
- B) Lower Rear Rail**
- C) Upper Rear Rail**
- D) Rear Sub-Rail**
- E) Rear Stile**
- F) Muntin**
- G) Panel**
- H) Corbel**

Exploded View of Chair Side

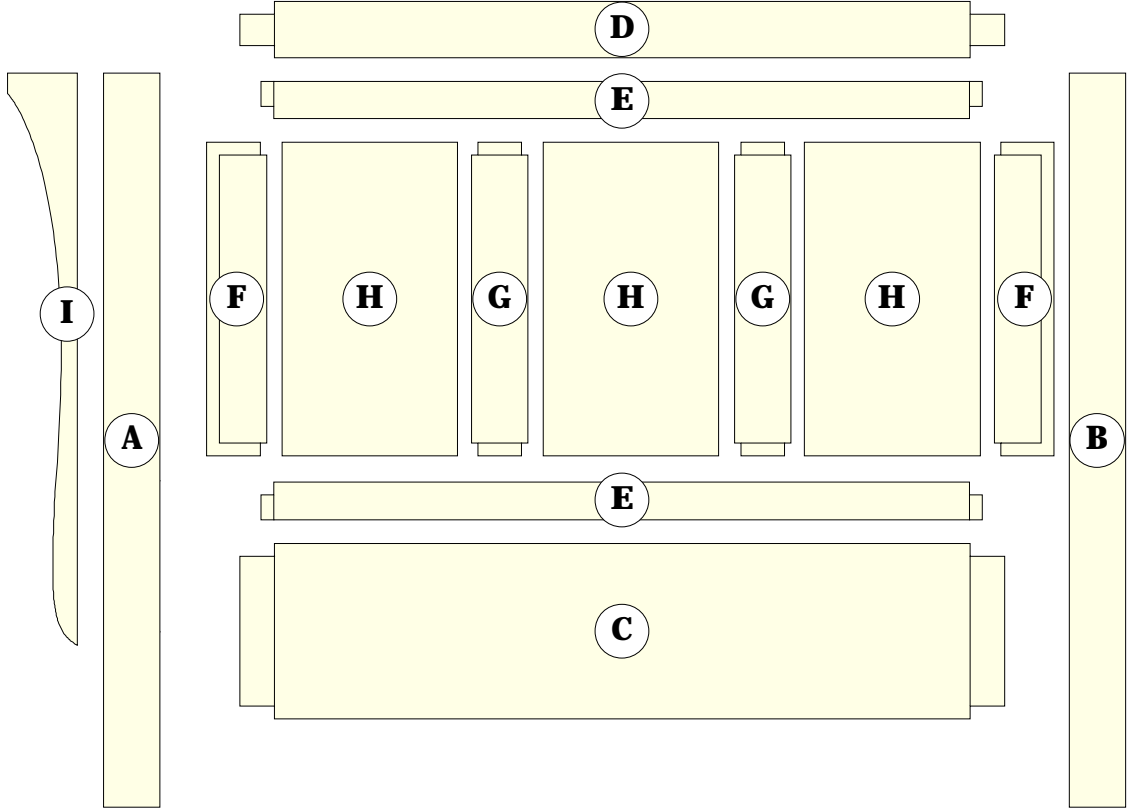

- A) Rear Leg
- B) Front Leg
- C) Lower Side Rail
- D) Upper Side Rail
- E) Side Sub-Rail
- F) Side Stile
- G) Muntin
- H) Panel
- I) Corbel

Positioning of Seat Frame Support and Spacers

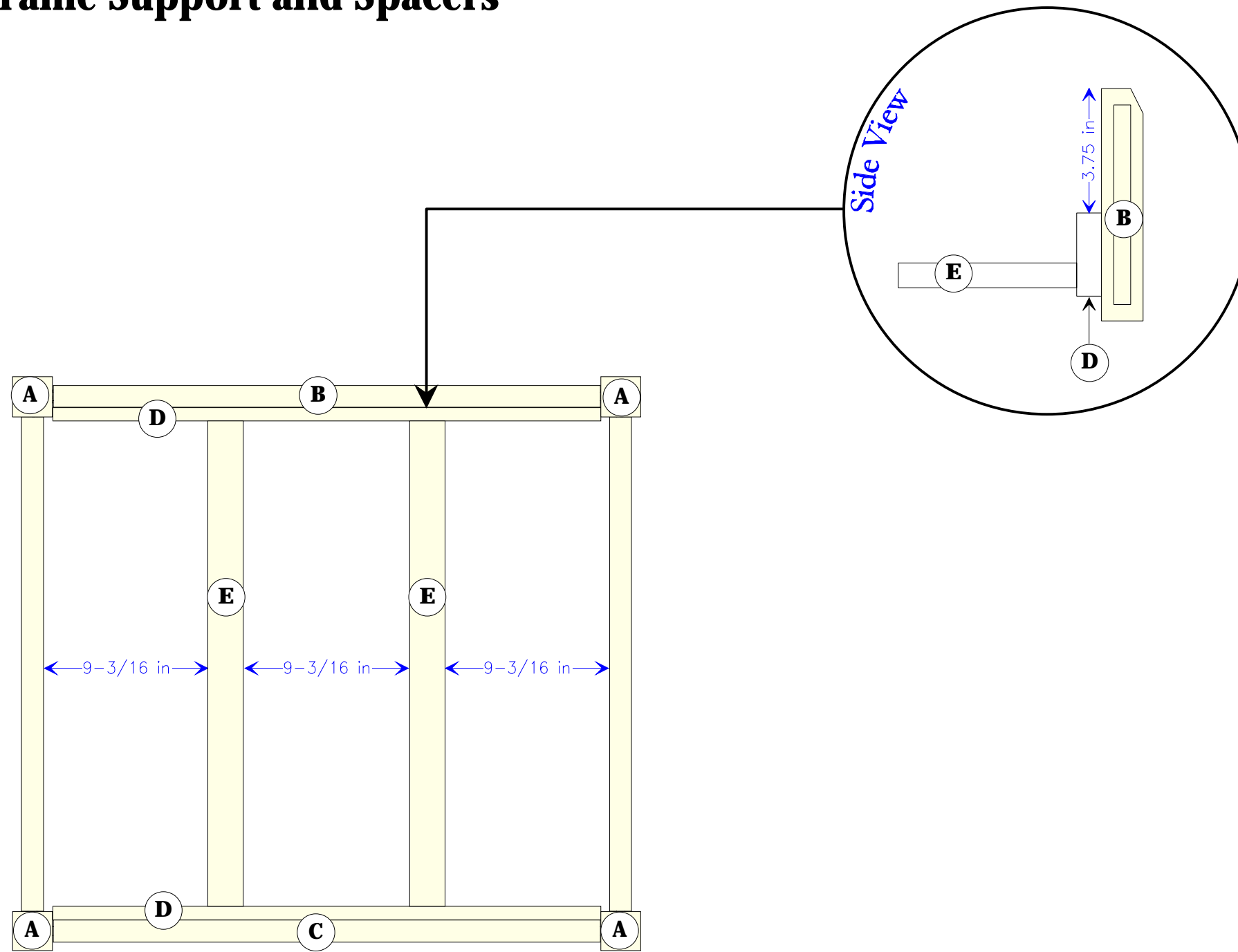

- A) Leg
- B) Front Rail
- C) Lower Rear Rail
- D) Seat Frame Support
- E) Spacer

Front Leg (2 Each - Reversed)

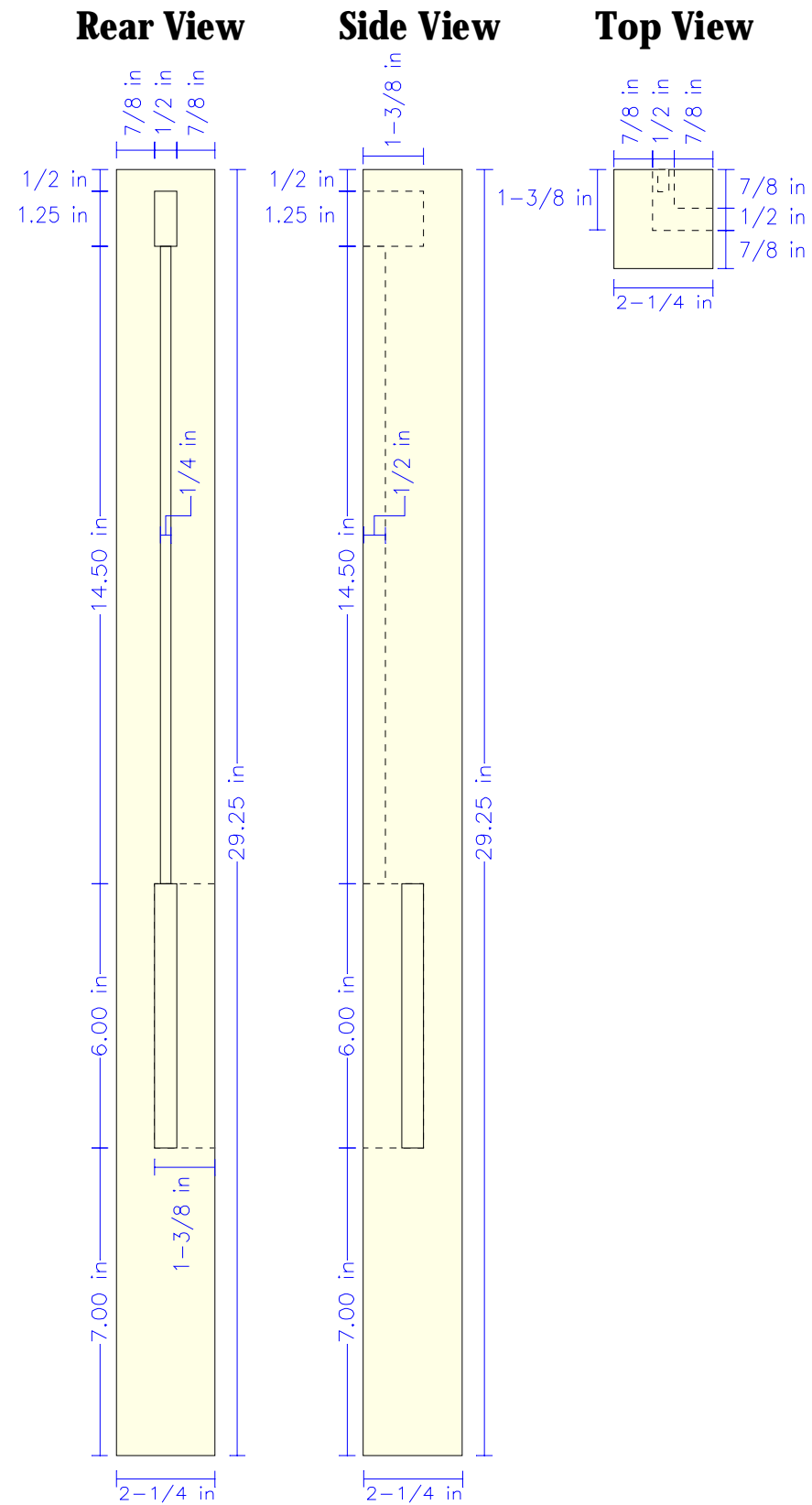

Rear Leg (2 Each)

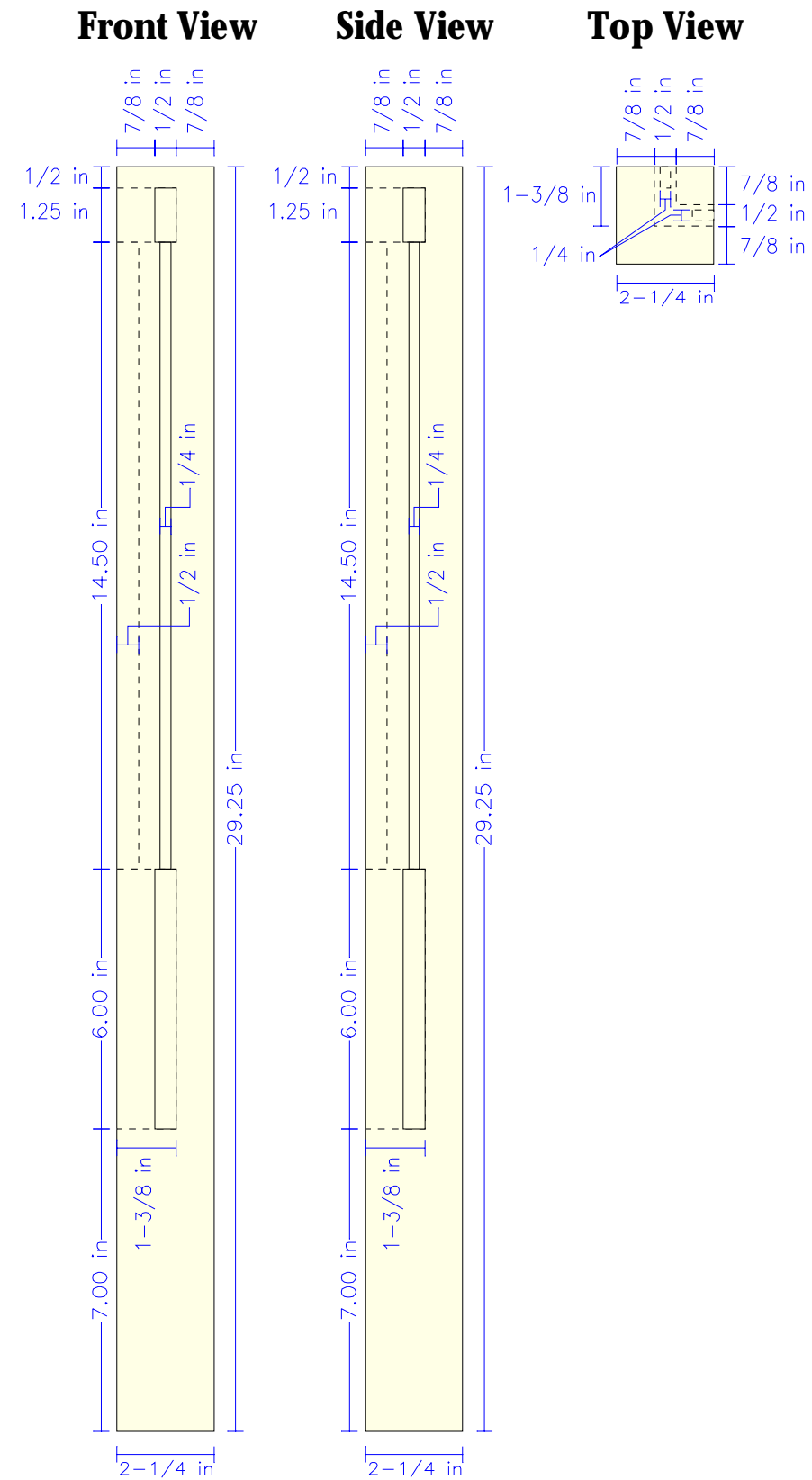

Side Stile (4 Each)

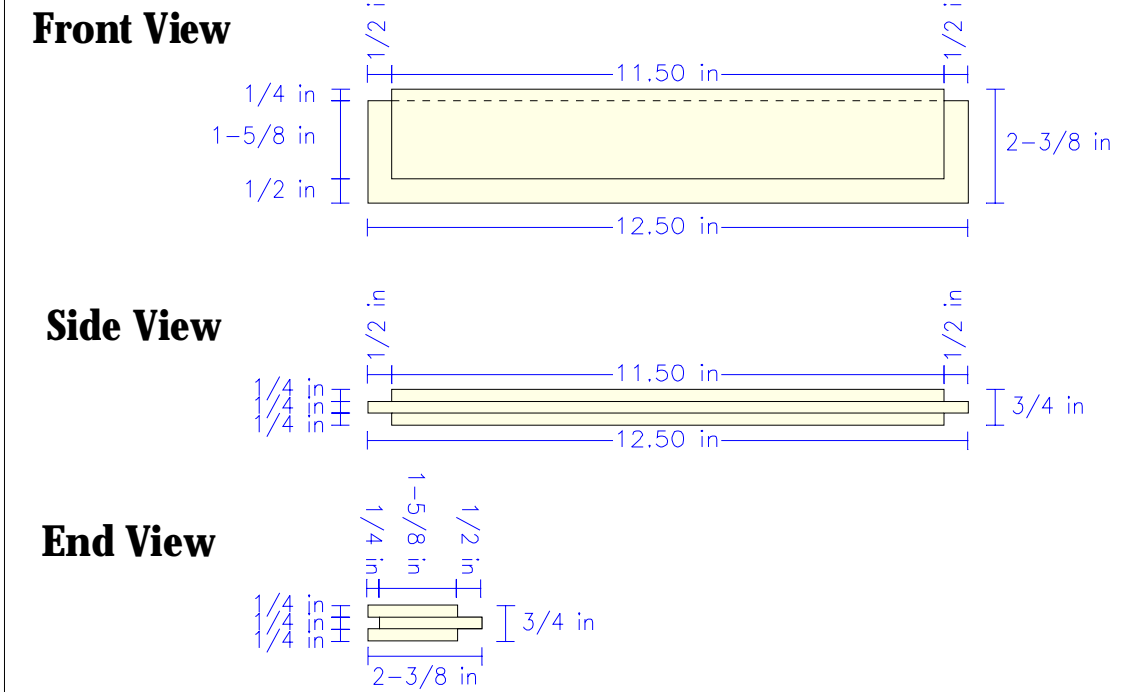

Muntin (11 Each)

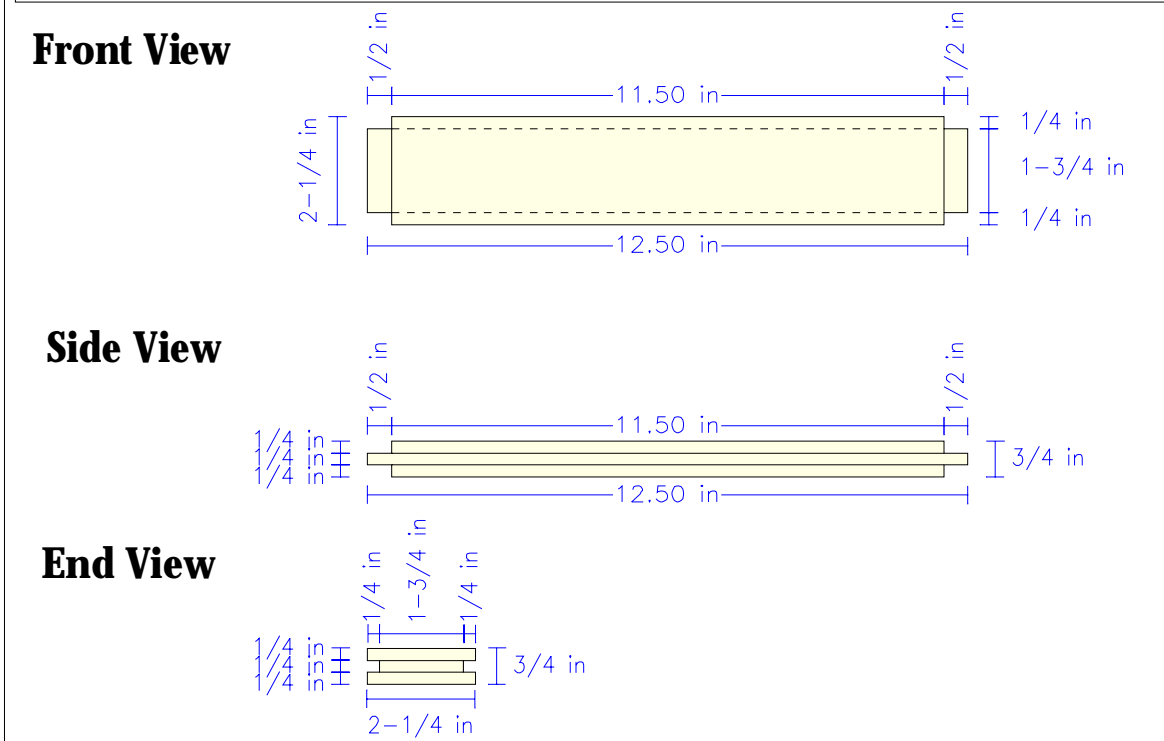

Panel (14 Each)

Front View

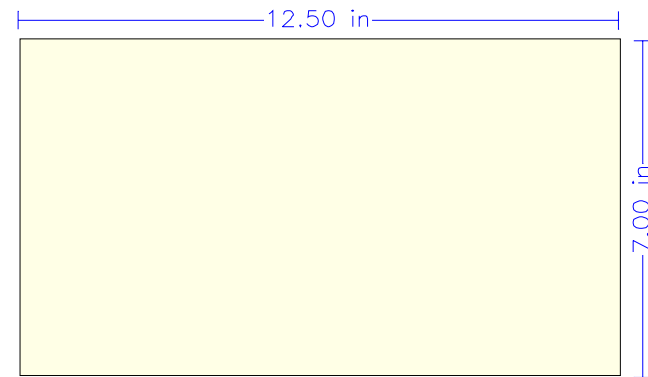

Side View

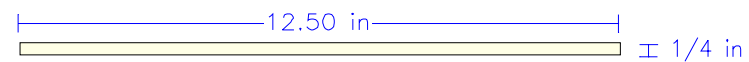

End View

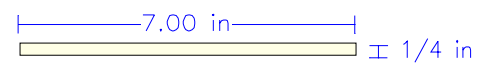

Rear Stile (2 Each)

Front View

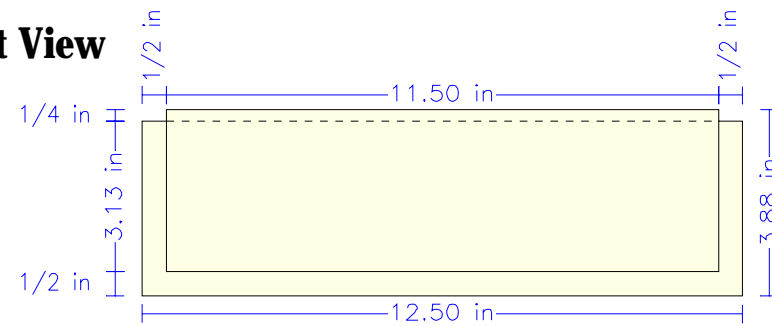

Side View

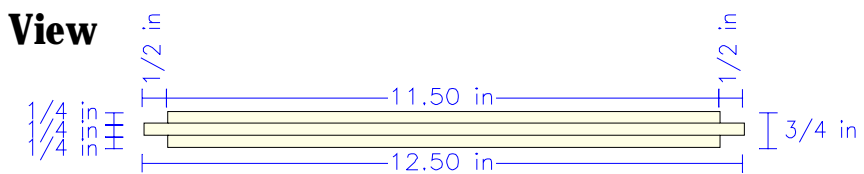

End View

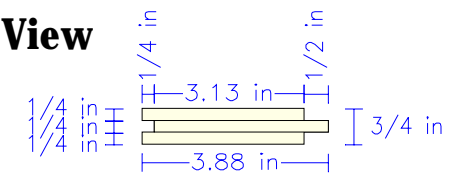

Lower Side Rail (2 Each)

Front View

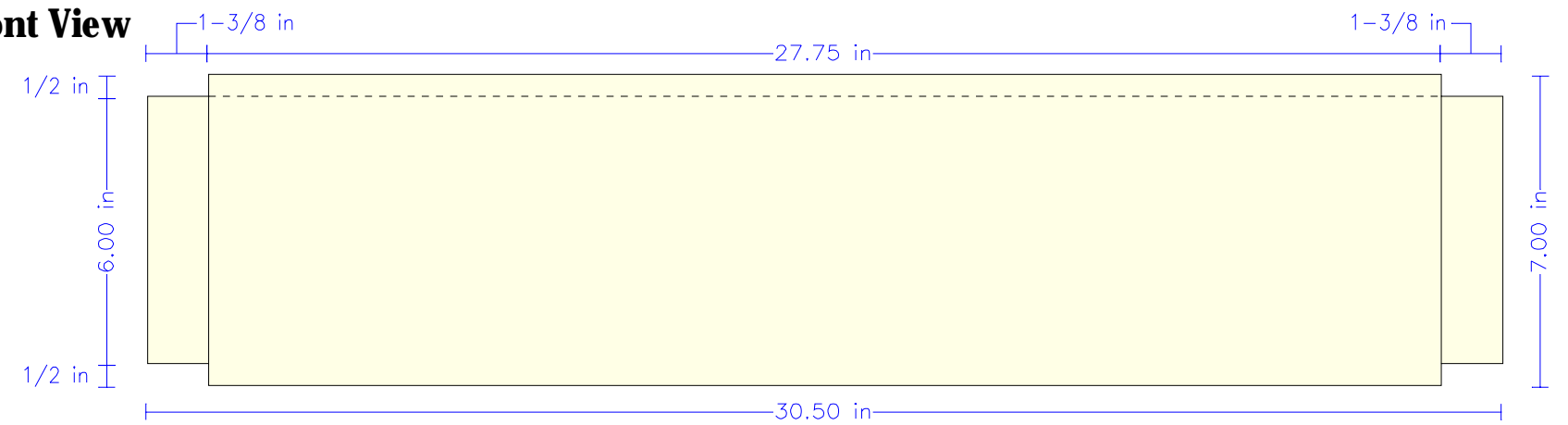

Top View

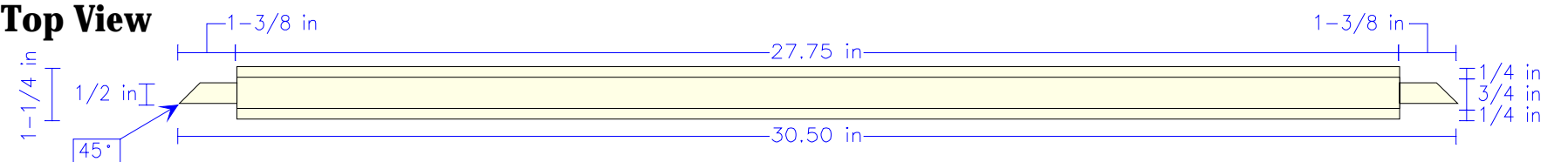

End View

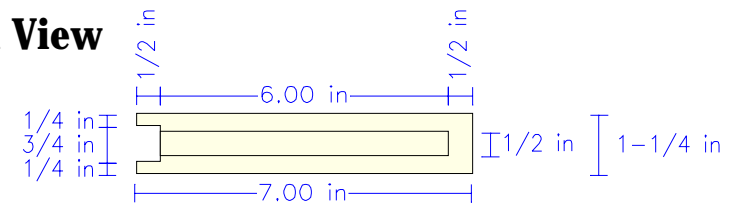

Upper Side Rail (2 Each)

Front View

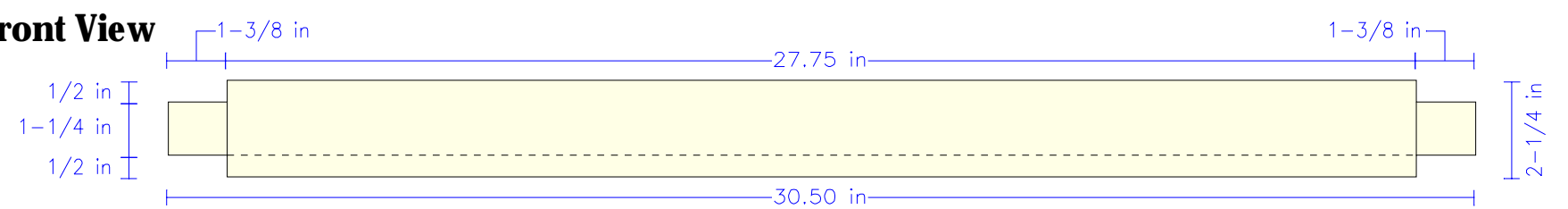

Top View

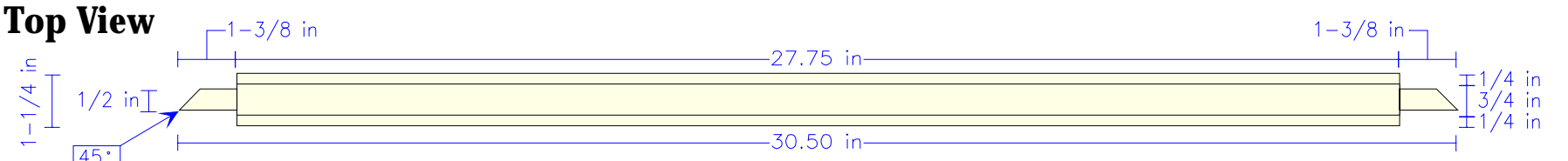

End View

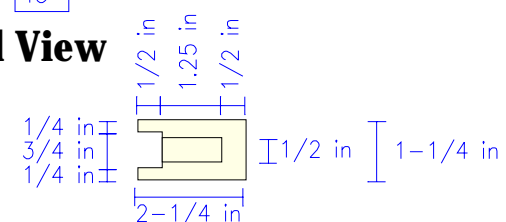

Side Sub-Rails (4 Each)

Front View

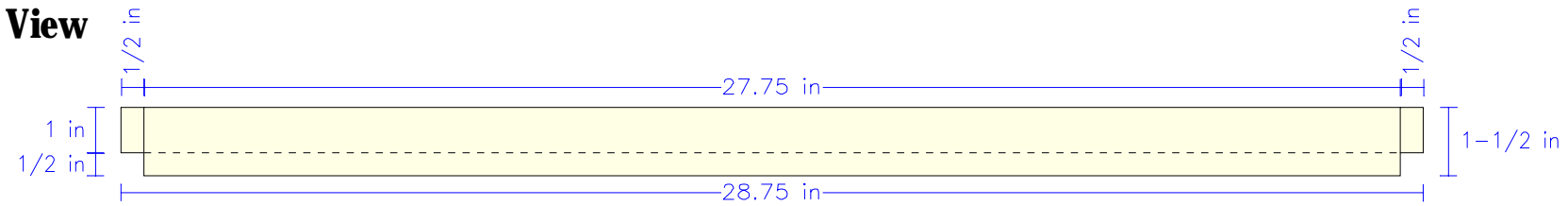

Top View

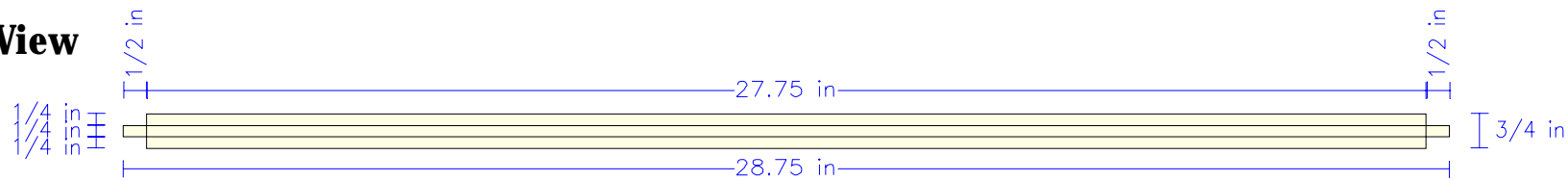

End View

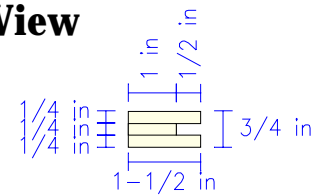

Arm Rest (2 Each)

Front View

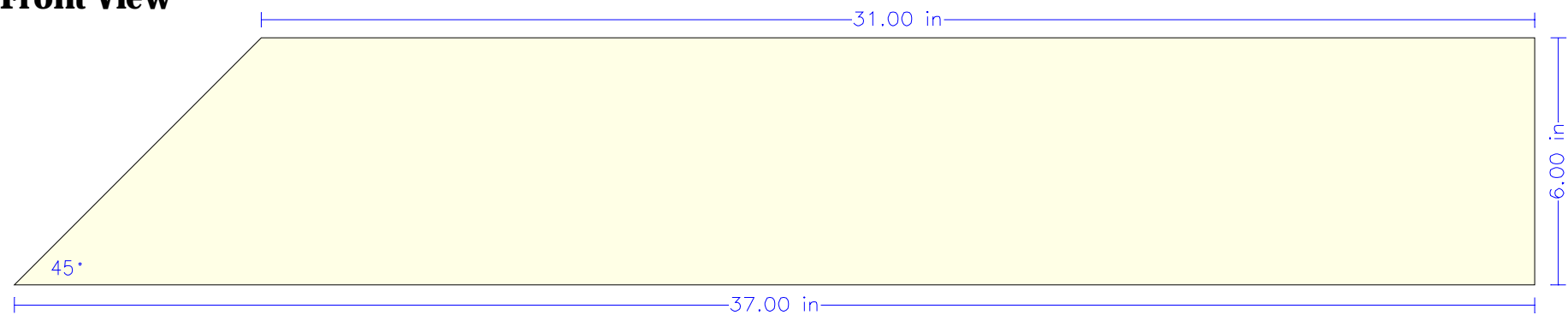

Top View

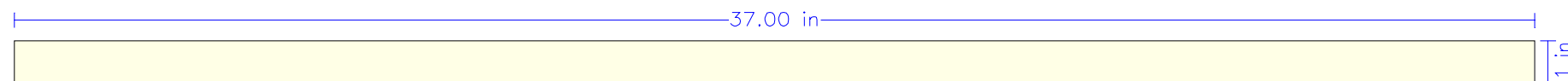

End View

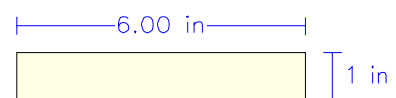

Corbel (6 Each)

Front View

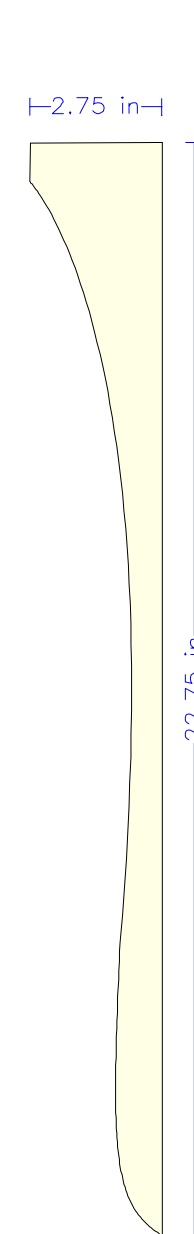

Side View

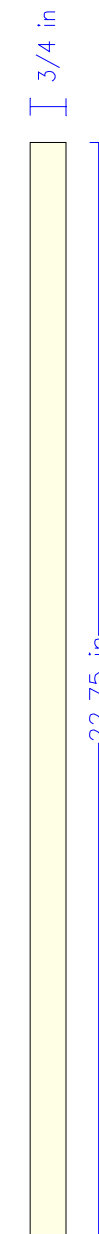

Top View

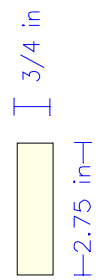

Lower Rear Rail (1 Each)

Front View

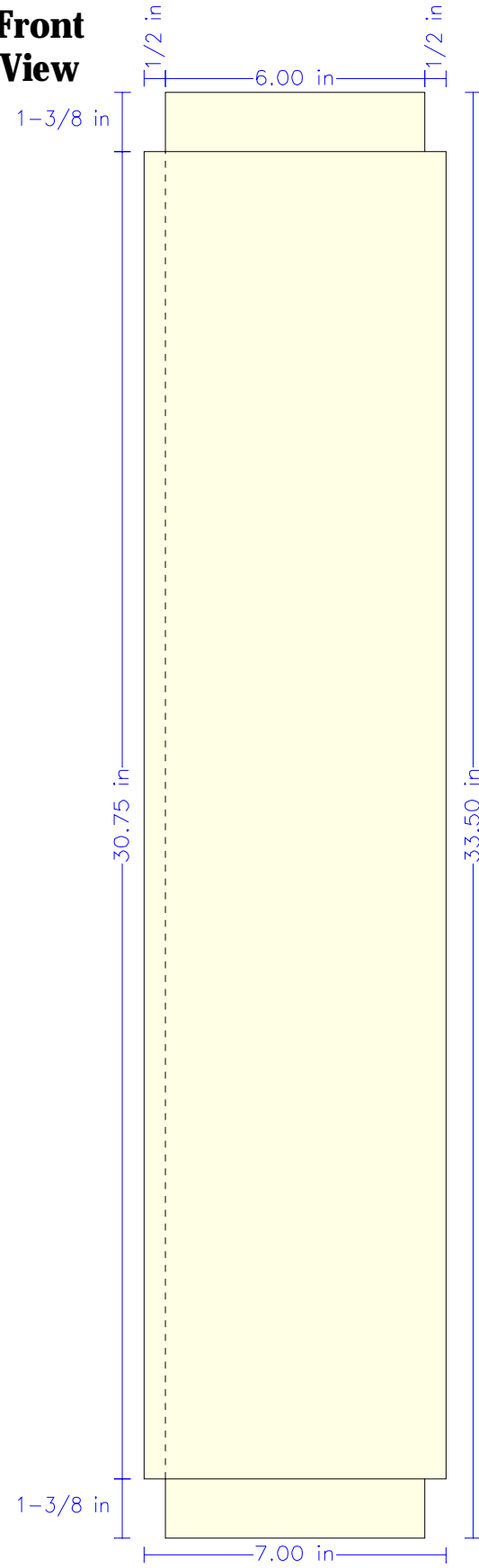

Top View

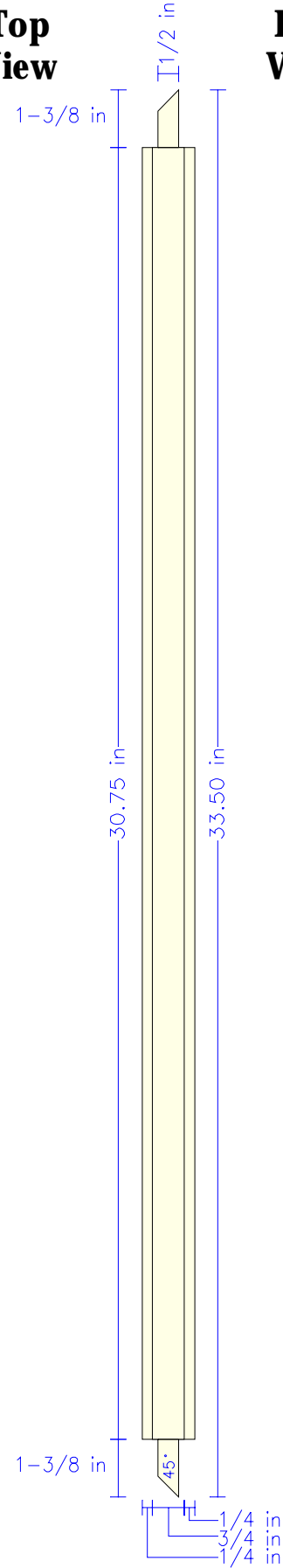

End View

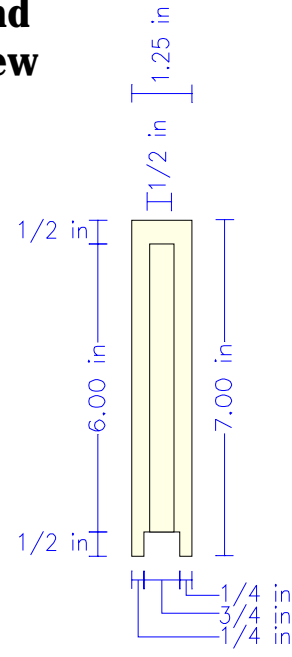

Front Rail (1 Each)

Front View

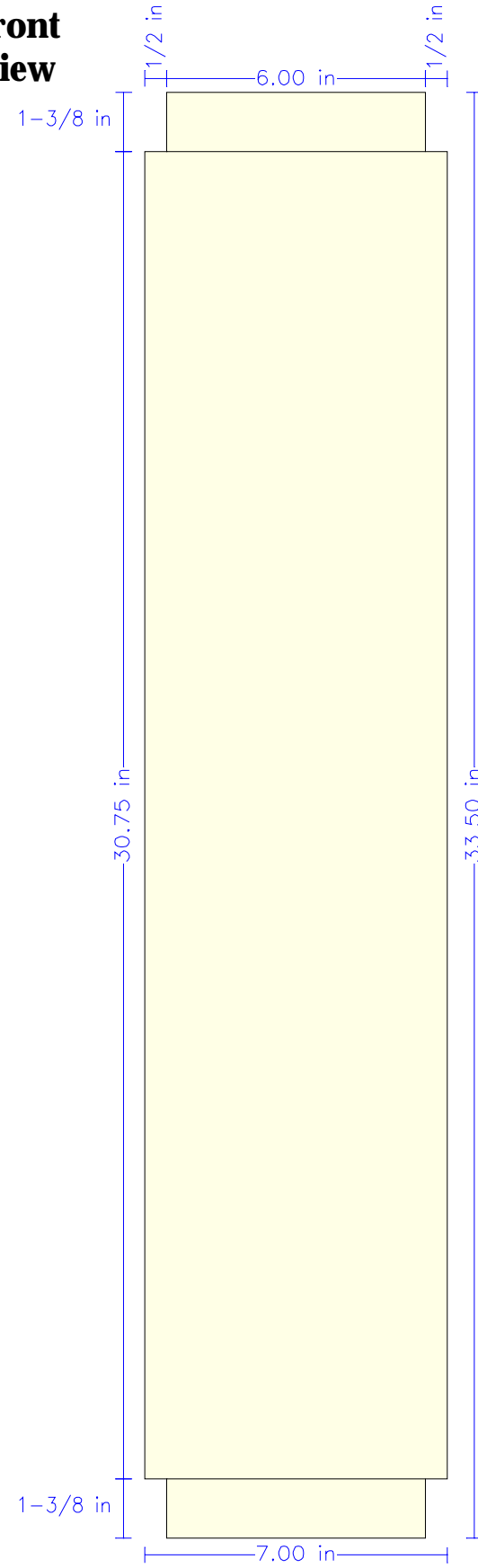

Top View

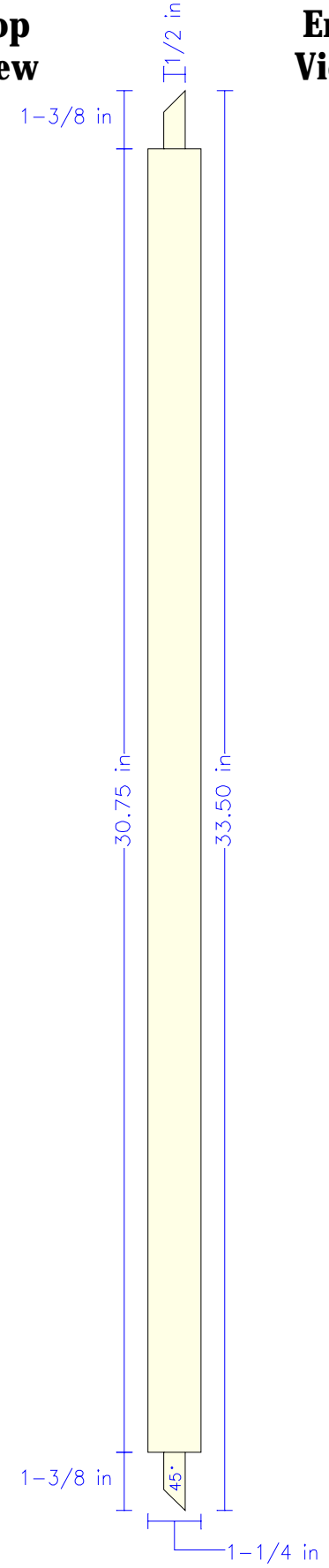

End View

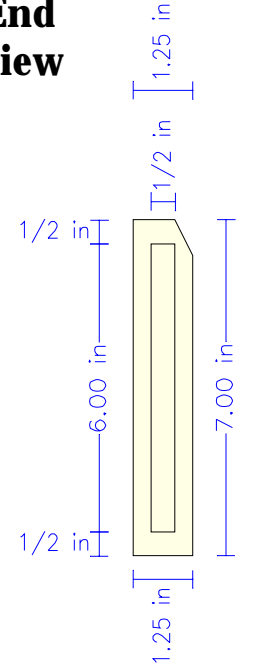

Upper Rear Rail (1 Each)

Front View

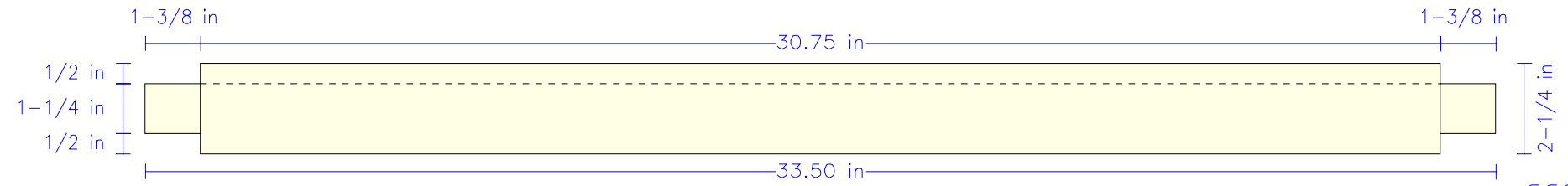

Top View

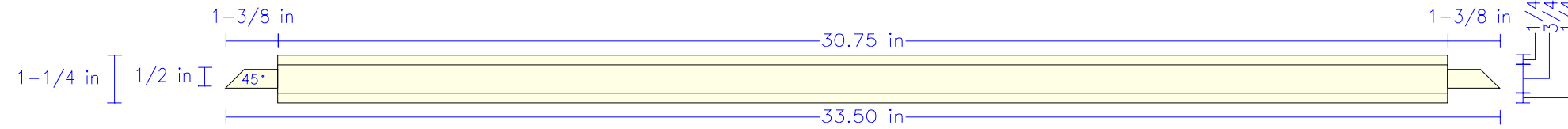

End View

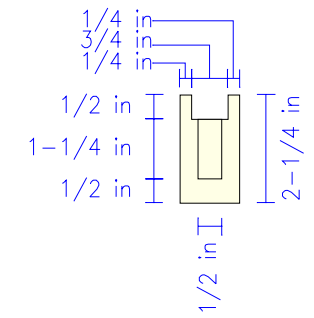

Rear Sub-Rail (2 Each)

Front View

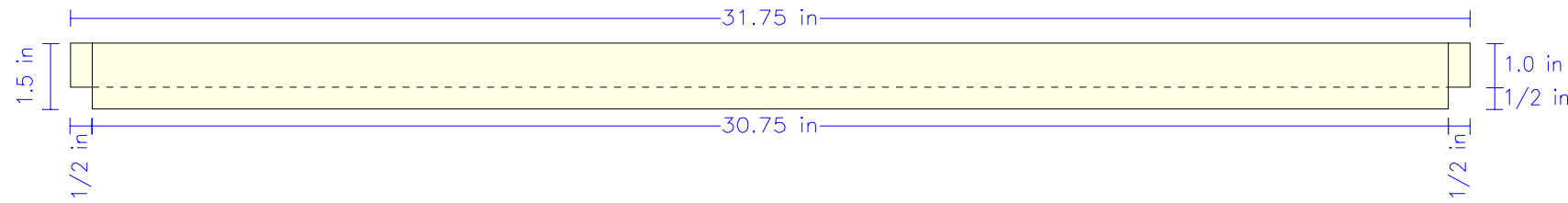

Top View

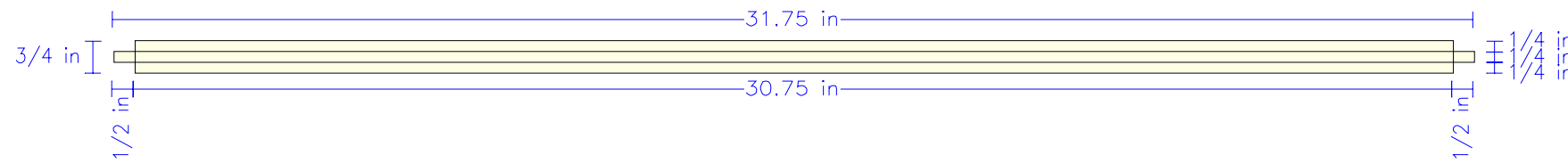

End View

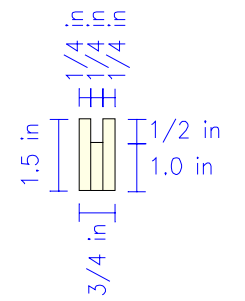

Seat Spacer (2 Each)

Front View

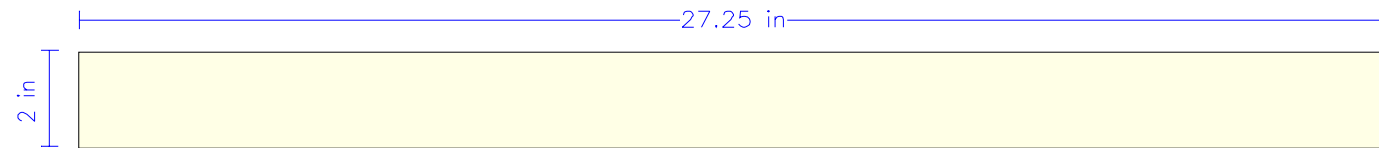

Top View

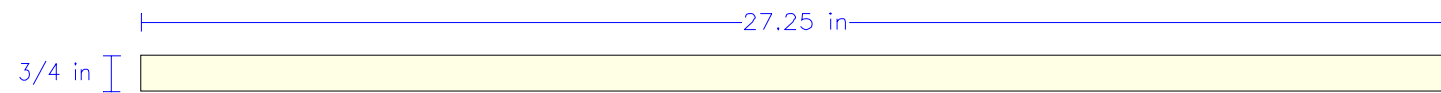

End View

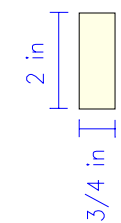

Rear Arm Rest (1 Each)

Top View

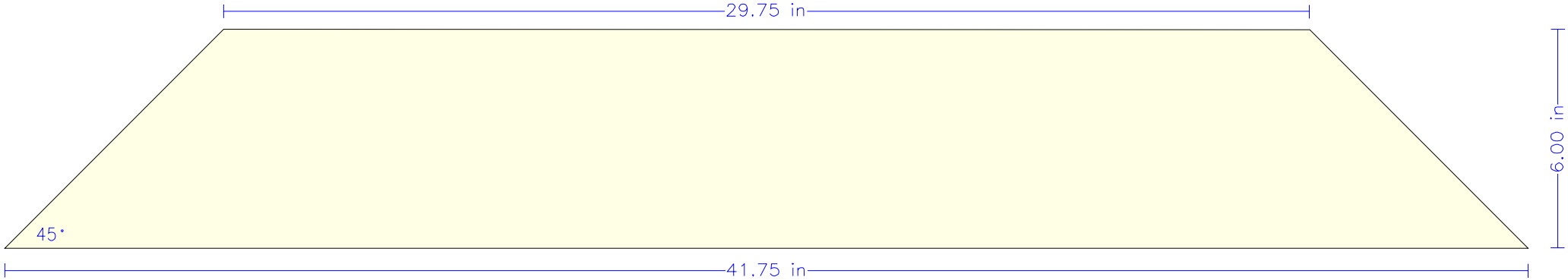

Front View

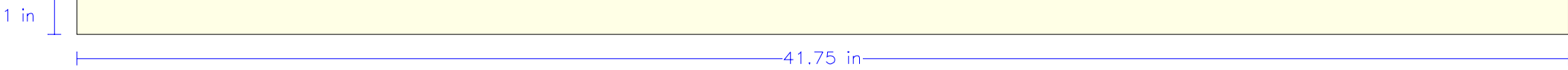

End View

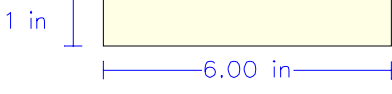

Seat Frame Support (2 Each)

Front View

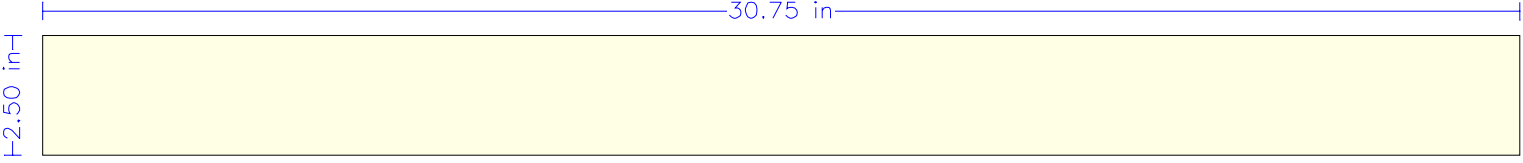

Side View

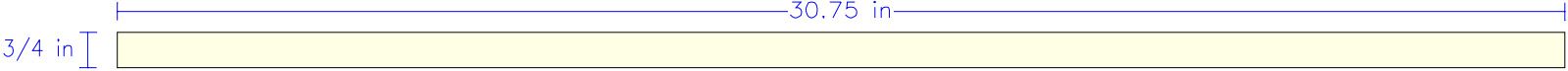

End View

