

2-D and 3-D Shapes

2nd
GRADE

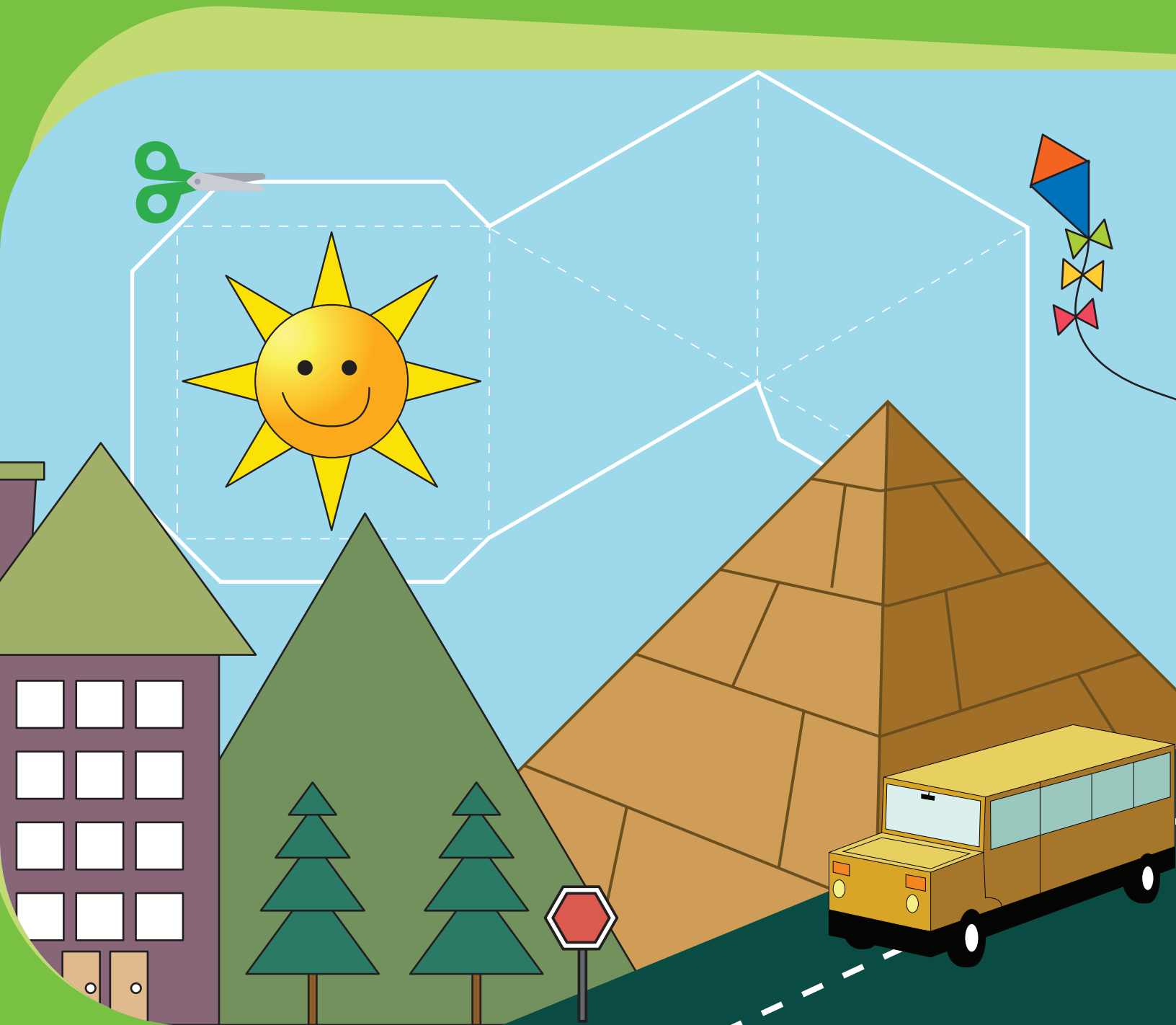

Table of Contents

2-D and 3-D Shapes

Plane Figures
2-Dimensional Shapes
Name That Shape #1
Name That Shape #2
Sphere to Apple
Triangle to Pyramid
Prism to Bus
Jack-in-the-Box
Ice Cream Cone
The Cylinder
3-D Shapes
Shapes Within Shapes
Math Models: Cube
Math Models: Triangular Prism
Math Models: Rectangular Prism
Math Models: Triangle Pyramid
Math Models: Pyramid
Math Models: Cone
3-D Art

Certificate of Completion

Want more workbooks? Join [Education.com Plus](http://www.education.com/education-plus/) to save time and money.
<http://www.education.com/education-plus/>

Plane Figures

Plane geometry is about shapes like lines, circles, and triangles. Plane figures are made up of a set of sides or curved segments. These are called edges of the figure. The rectangle, the triangle, the square, the hexagon, and the circle are just a few plane figures. Color the picture below using the same color for each shape.



rectangle



triangle



square



hexagon



circle



trapezoid



2-Dimensional Shapes



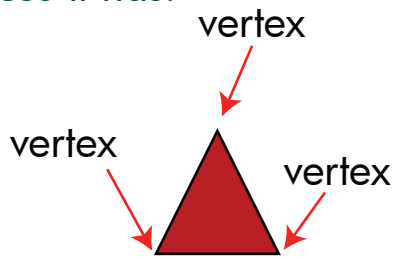

In plane geometry, shapes are made up of a set of sides or curved segments; these are the edges of a shape. A vertex (plural: vertices) is a point where two or more straight lines meet, like a corner. An edge is a line segment that joins two vertices. Draw or label each shape, and write how many edges and vertices it has.

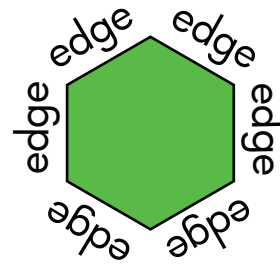

This triangle has 3 vertices.



This hexagon has 6 edges.

Shape	Name	Number of Edges	Number of Vertices
	circle	0 or undefined/infinite	0 or undefined/infinite
	kite		
			
	rectangle		
			
		4 (same size)	4
			
	triangle		
	hexagon		

Name That Shape

Match each clue to the correct shape. Then take each letter inside the shape and write it in order to spell out the answer to the riddle.

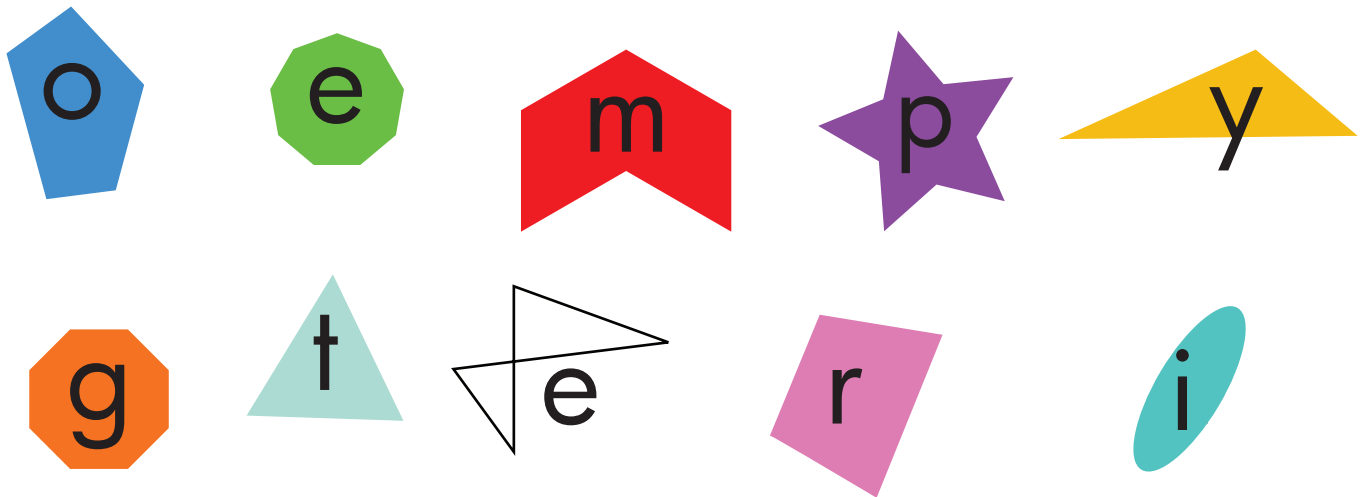

This shape is called an *octagon*. It has 8 sides and is used for stop signs.

This shape is called a *nonagon* and has 9 sides.

This shape is called an *irregular pentagon* because the sides are not the same size.

This hexagon has one *vertex concave* or has a "cave" in it.

When two sides cross over, you call it a "complex" quadrilateral.

This triangle is an *acute triangle* because all of its angles are less than 90° .

Any four-sided shape is a quadrilateral.

This triangle is an *obtuse triangle* because one of its angles is greater than 90° .

What kind of tree does a math teacher climb?

Name That Shape

Match each clue to the correct shape. Then take each letter inside the shape and write it in order to spell out the answer to the riddle.

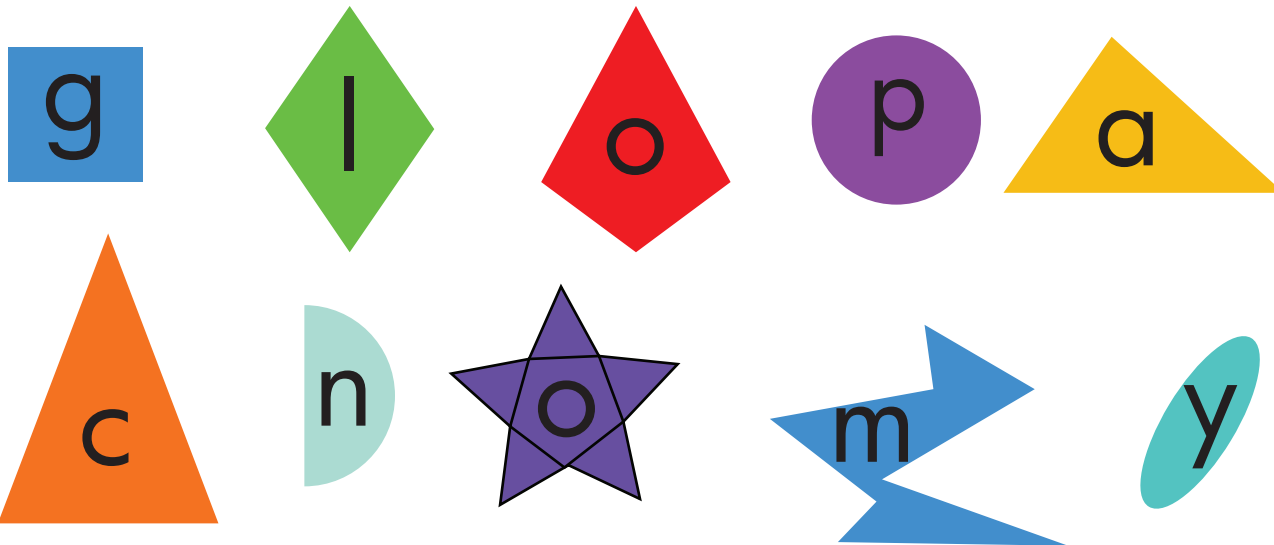

The 3-D version of this shape is called a *sphere*.

This shape is made out of a pentagon and is called a *pentagram*.

This shape has 4 equal sides and is called a *rhombus*.

This shape looks like a squashed circle and is called an *ellipse*.

This shape has 4 right angles.

This shape is called a *kite* and has 2 pairs of equal adjacent sides.

This shape has 2 vertices and is called a *semicircle*.

What do you say when you see an empty parrot cage?

Name That Shape

Match each clue to the correct shape. Then take each letter inside the shape and write it in order to spell out the answer to the riddle.

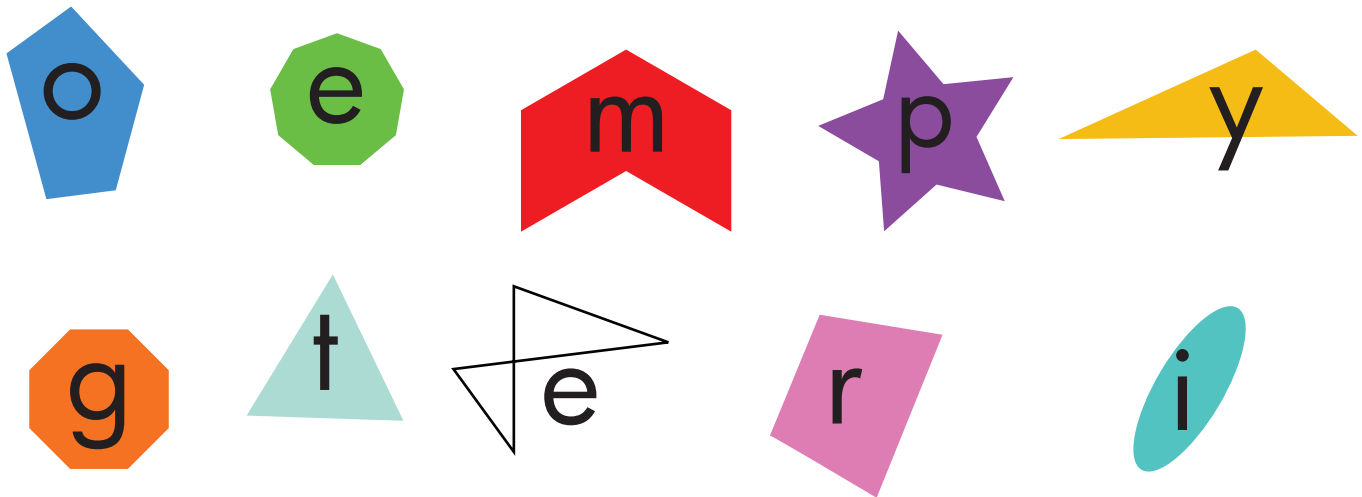

This shape is called an *octagon*. It has 8 sides and is used for stop signs.

This shape is called a *nonagon* and has 9 sides.

This shape is called an *irregular pentagon* because the sides are not the same size.

This hexagon has one *vertex concave* or has a "cave" in it.

When two sides cross over, you call it a "complex" quadrilateral.

This triangle is an *acute triangle* because all of its angles are less than 90° .

Any four-sided shape is a quadrilateral.

This triangle is an *obtuse triangle* because one of its angles is greater than 90° .

What kind of tree does a math teacher climb?

Sphere To Apple

Every 3-D shape has three dimensions: width, depth and height. For example, compare the circle and the sphere. A sphere has *depth*, which a 2-D circle does not have. Let's use this knowledge to draw a 3-D apple.

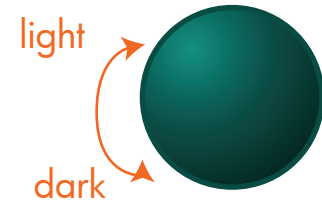
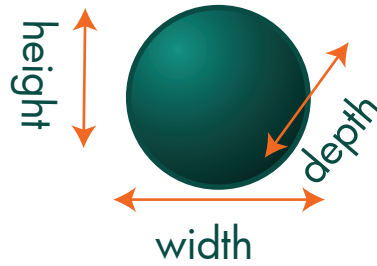
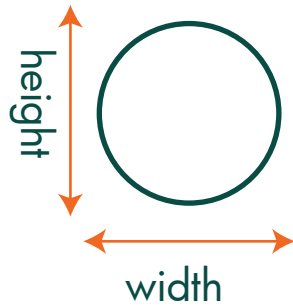

Shading (effect of light):
goes from light (presence of light)
to dark (absence of light).

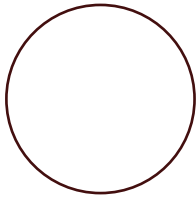
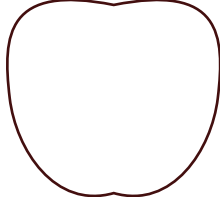
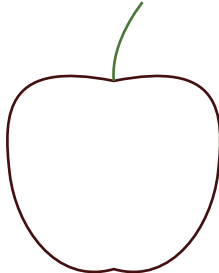
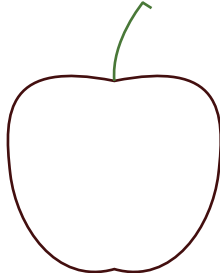
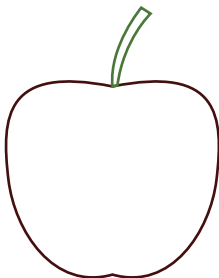
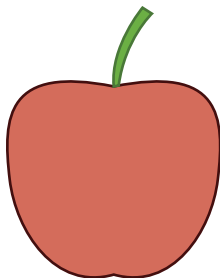
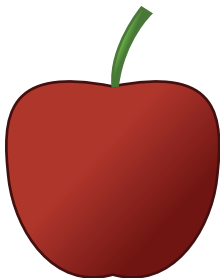
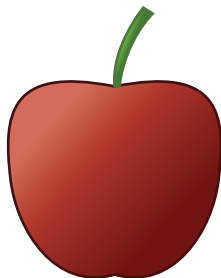

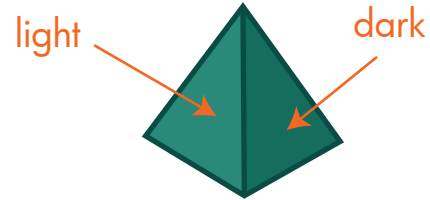
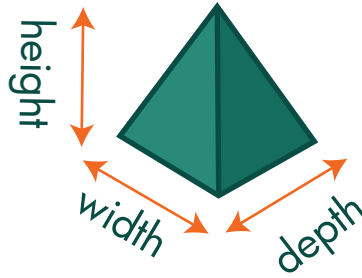
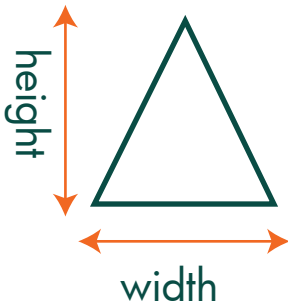

 <p>Let's start with a circle.</p>	 <p>Now change the circle so it has an apple-like shape.</p>	 <p>Draw a small curve for one side of the stem.</p>	 <p>Add the top of the stem.</p>
 <p>Add the other side to form the stem.</p>	 <p>Color the apple red and add green to the stem.</p>	 <p>Add a darker red to the bottom of the apple and dark green to the stem.</p>	 <p>Add a lighter red at the top, and softly blur one color into another.</p>

Triangle To Pyramid

Solid geometry is the study of 3-D shapes. For example, compare the triangle to the pyramid. A pyramid has an extra dimension called *depth*. Let's turn a triangle into a pyramid.

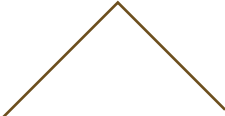
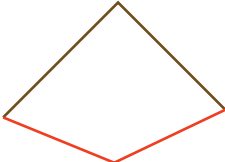
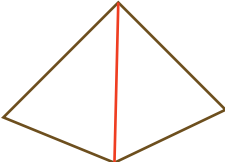

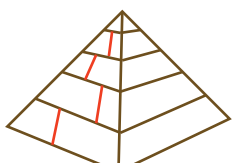
Shading (effect of light):
goes from light (presence of light)
to dark (absence of light).

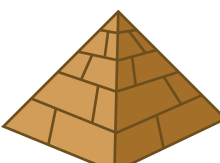
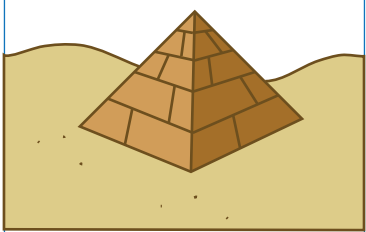
 <p>Let's start with the top sides of a triangle.</p>	 <p>Add an upside-down triangle to the bottom.</p>	 <p>Add a line to form the two sides of the pyramid.</p>	 <p>Divide the sides of the pyramid with lines to form the bricks.</p>
 <p>Draw lines to make the various bricks of the pyramid.</p>	 <p>Make the bricks for the other side.</p>	 <p>Add a lighter sand color and a darker sand color to the sides of the pyramid.</p>	 <p>Add some hills and use dots to add texture to the sand.</p>

Prism To Bus

A prism is a polyhedron. That means that the cross-section will be a polygon (a straight-edged figure), so all sides will be flat!

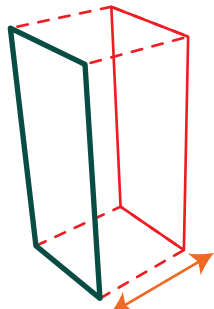

Draw a shape and extend it out.

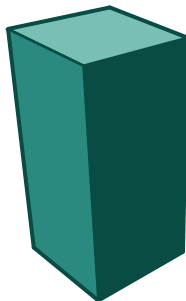

This is a rectangular prism.

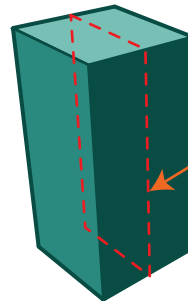

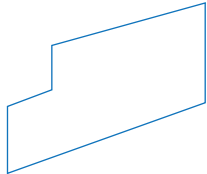
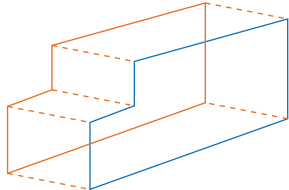
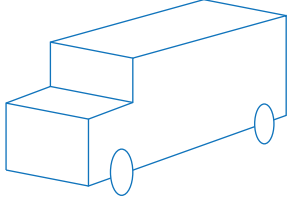
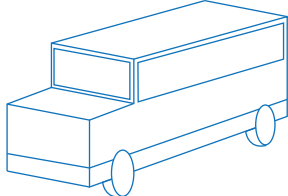
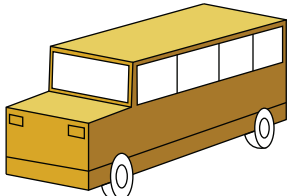
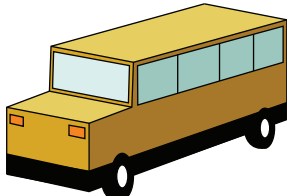
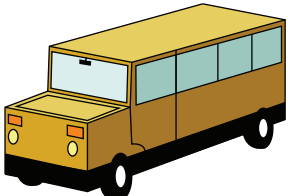
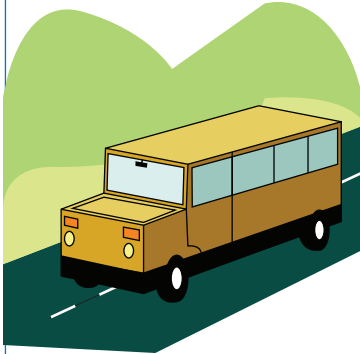

A slice from this is called a cross-section.

This cross-section will always be a rectangle.

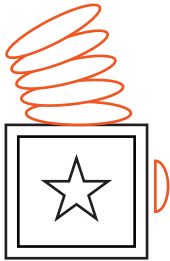
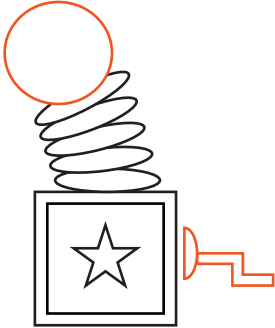
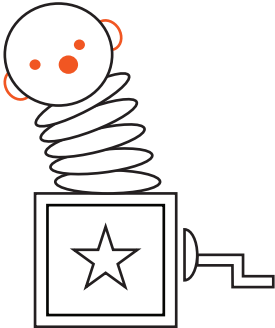
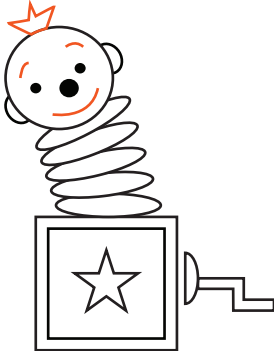
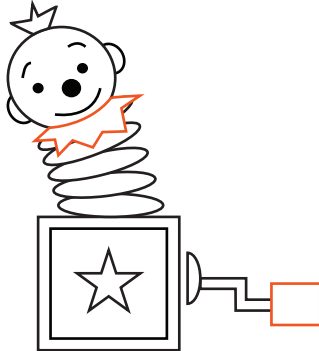
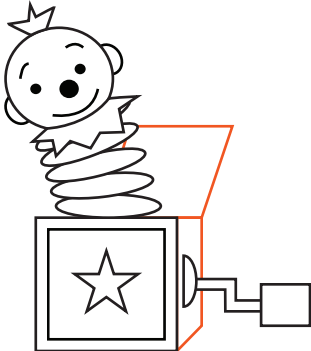
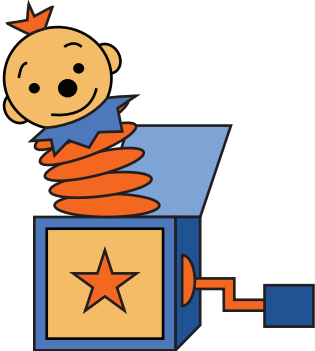
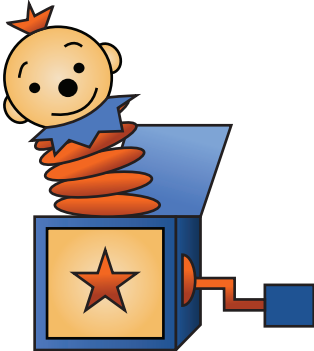
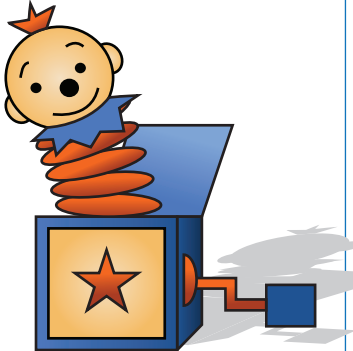

 <p>Let's start with a six-sided polygon shaped like a bus.</p>	 <p>Extend the shape to form a 3-D bus.</p>	 <p>Erase some of the lines that we don't need and add wheels.</p>	 <p>Add rectangles for windows, extend the wheels, and add a line to form the bumper.</p>
 <p>Let's shade in the side, front and top with lighter to darker yellows.</p>	 <p>Color in the windows, lights and bumper of the bus.</p>	 <p>It's time to have fun and add more details to the bus.</p>	 <p>Add some hills and a road, and you are done!</p>

By combining simple shapes, we can create complex drawings. Let's draw a jack-in-the-box toy!

 <p>Start with a square and add a smaller square inside.</p>	 <p>Now add a star in the middle to decorate it.</p>	 <p>Draw the some ellipses and a half circle for the lever.</p>	 <p>Add a circle for the head and a zigzag shape for the lever.</p>
 <p>Now add circles for the face and half-circles for the ears.</p>	 <p>Add curves for the eyebrows and a puff of hair.</p>	 <p>Let's add the handle and a decoration below the neck.</p>	 <p>Now extend the box and add the cover.</p>
 <p>Add some colors!</p>	 <p>Use darker colors and lighter colors to shade him.</p>	 <p>Then add a little shadow.</p>	<p>Great job! You are done!</p>

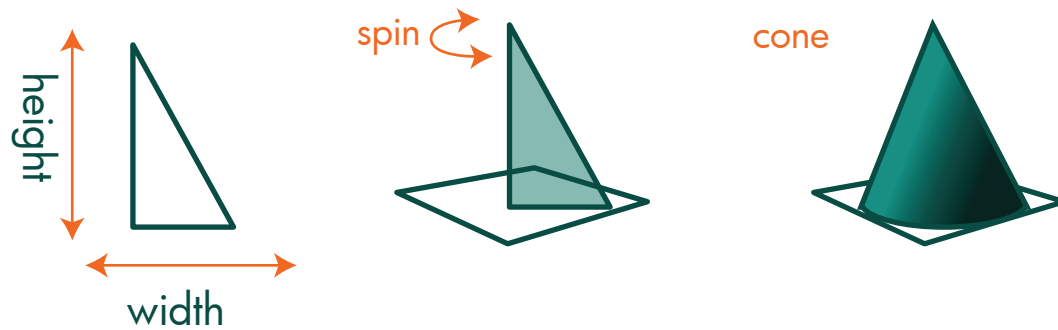
The cone is another 3-D solid. It is made by spinning a right-angled triangle. The cone can be used to draw many things. Let's draw an ice cream cone!

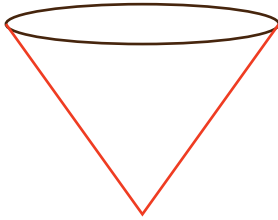
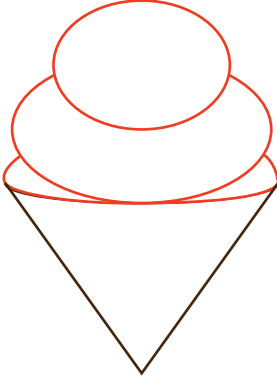
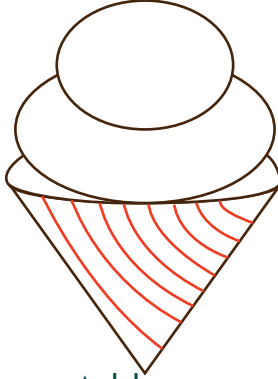
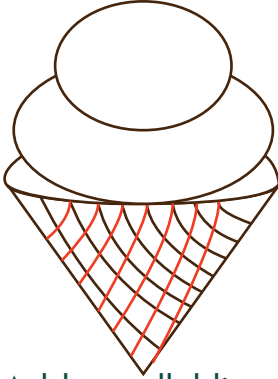
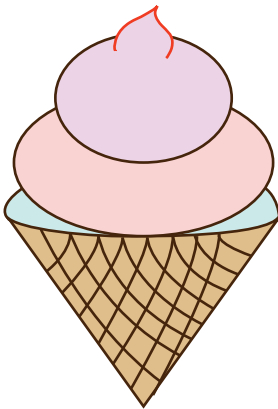



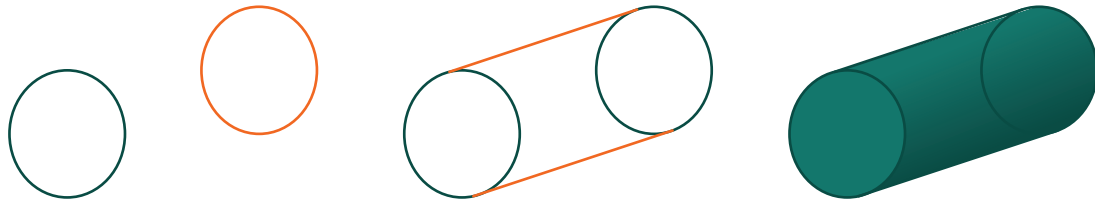

 <p>First, start with an ellipse.</p>	 <p>Now draw an upside-down triangle.</p>	 <p>Add some circles for the ice cream.</p>	 <p>Add some parallel curves to the ice cream cone.</p>
 <p>Add parallel lines going in the opposite direction.</p>	 <p>Add some color and a rounded triangle.</p>	 <p>Now shade with darker colors.</p>	 <p>Finally, add a cherry on top!</p>

The Cylinder

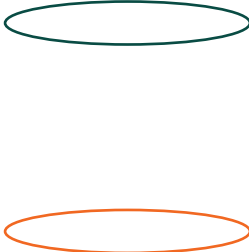
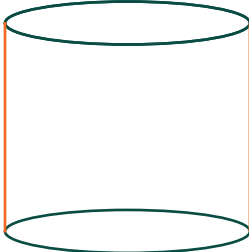
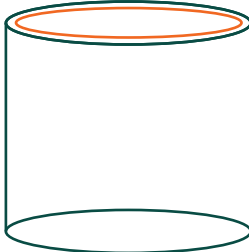
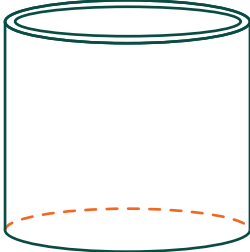
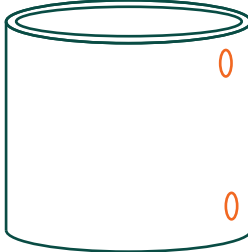
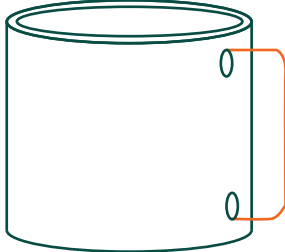
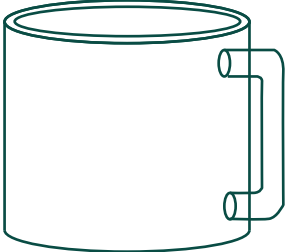
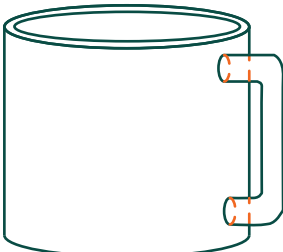
The cylinder is another 3-D solid. It is made by drawing an ellipse (or circle), then adding another ellipse that is farther away, and finally connecting them with 2 lines. The cylinder can be used to draw many things.



 <p>Let's start with an ellipse.</p>	 <p>Add another ellipse.</p>	 <p>Connect with 2 lines.</p>	 <p>Add another ellipse.</p>
 <p>Erase this line.</p>	 <p>Now draw two tiny ellipses.</p>	 <p>Connect the ellipses with a curved line.</p>	 <p>Add another curved line for a handle.</p>
 <p>Erase these lines.</p>	 <p>Let's add color.</p>	 <p>Shade with darker colors.</p>	 <p>Add some curves to make a hot cup of chocolate.</p>

Look at the shapes below. Fill out the table by writing the number of faces, edges, and vertices each shape has.

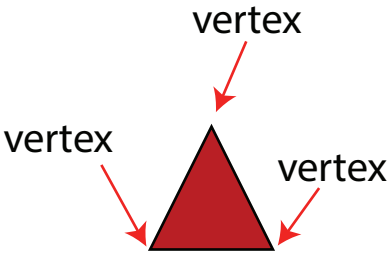
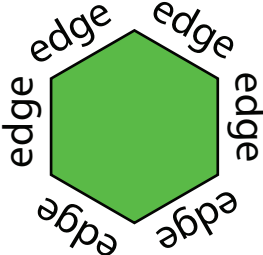
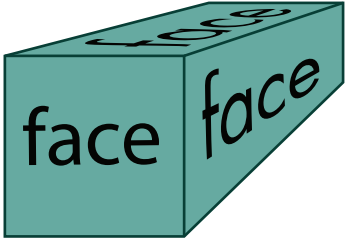
 <p>A vertex is a point where two or more straight lines meet. It is a corner.</p>	 <p>An edge is a line segment that joins two vertices.</p>	 <p>A face is an individual surface. This rectangle has 6 faces. (There are 3 faces you can't see.)</p>
---	--	--

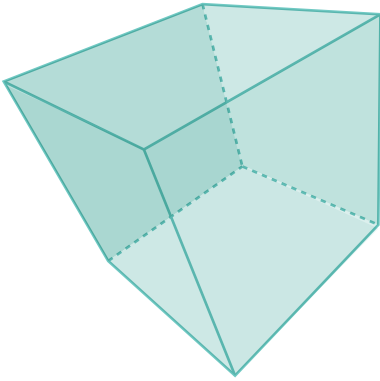
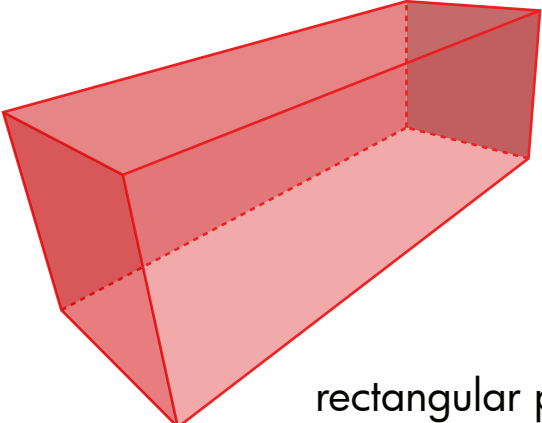
Shape	# of Faces	# of Edges	# of Vertices
 <p>cube</p>			
 <p>rectangular prism</p>			

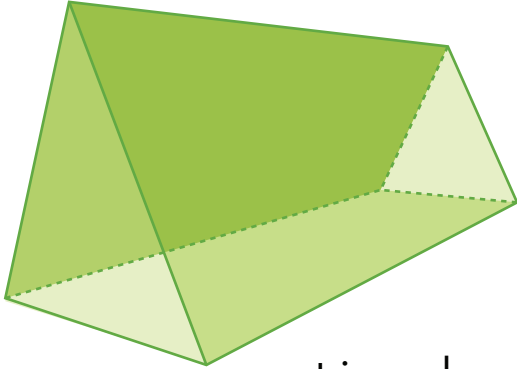
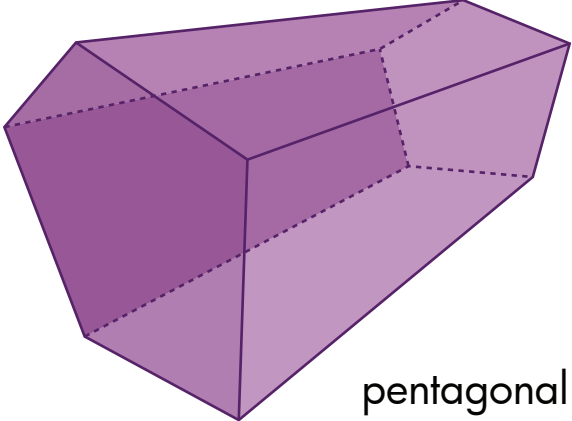
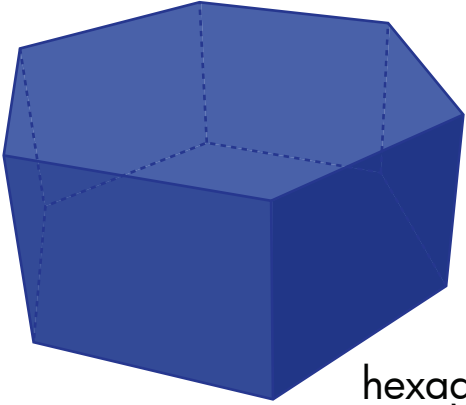
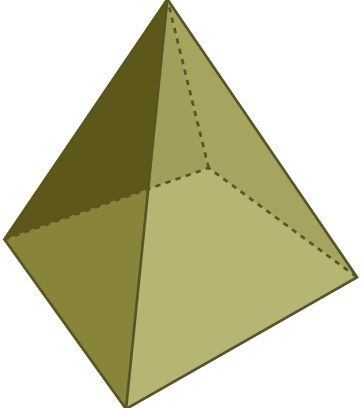
Shape	# of Faces	# of Edges	# of Vertices
 <p data-bbox="602 656 889 707">triangular prism</p>			
 <p data-bbox="571 1122 889 1173">pentagonal prism</p>			
 <p data-bbox="584 1579 889 1630">hexagonal prism</p>			
 <p data-bbox="738 2034 889 2084">pyramid</p>			

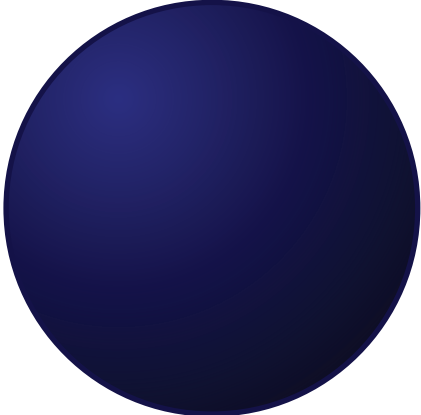
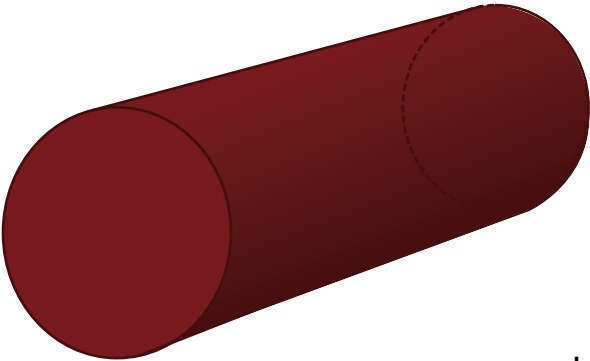
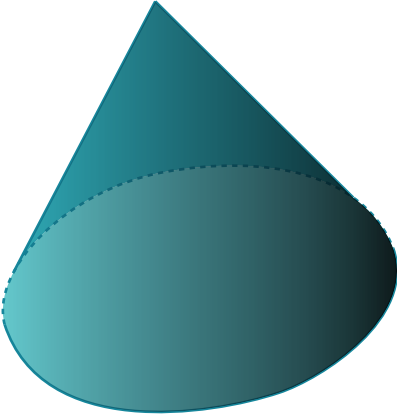
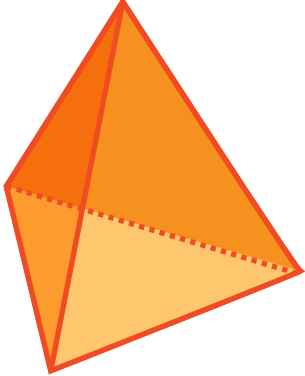
Shape	# of Faces	# of Edges	# of Vertices
 <p data-bbox="760 661 888 714">sphere</p>			
 <p data-bbox="738 1127 888 1180">cylinder</p>			
 <p data-bbox="797 1593 888 1632">cone</p>			
 <p data-bbox="424 2038 888 2091">triangular-based pyramid</p>			

Did you know that many 3-D shapes are made of 2-D shapes? Look at the 3-D shapes below. Write which 2-D shapes, and how many, you can see!

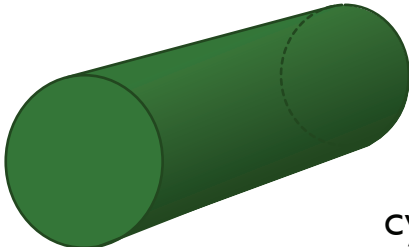
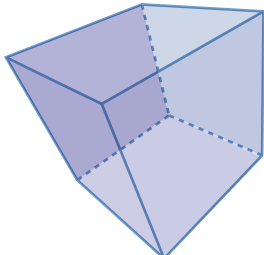
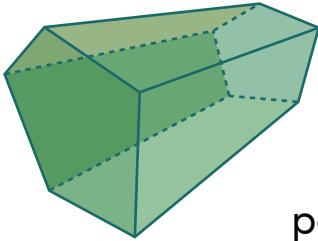
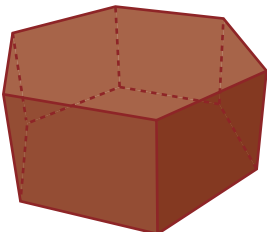
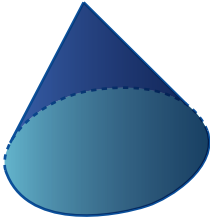
3-D Shape	2-D Shapes
 <p data-bbox="724 808 869 860">cylinder</p>	
 <p data-bbox="778 1097 869 1150">cube</p>	
 <p data-bbox="549 1389 869 1441">pentagonal prism</p>	
 <p data-bbox="567 1680 869 1733">hexagonal prism</p>	
 <p data-bbox="778 1979 869 2031">cone</p>	

MATH MODELS

CUBE

— CUT

- - - FOLD

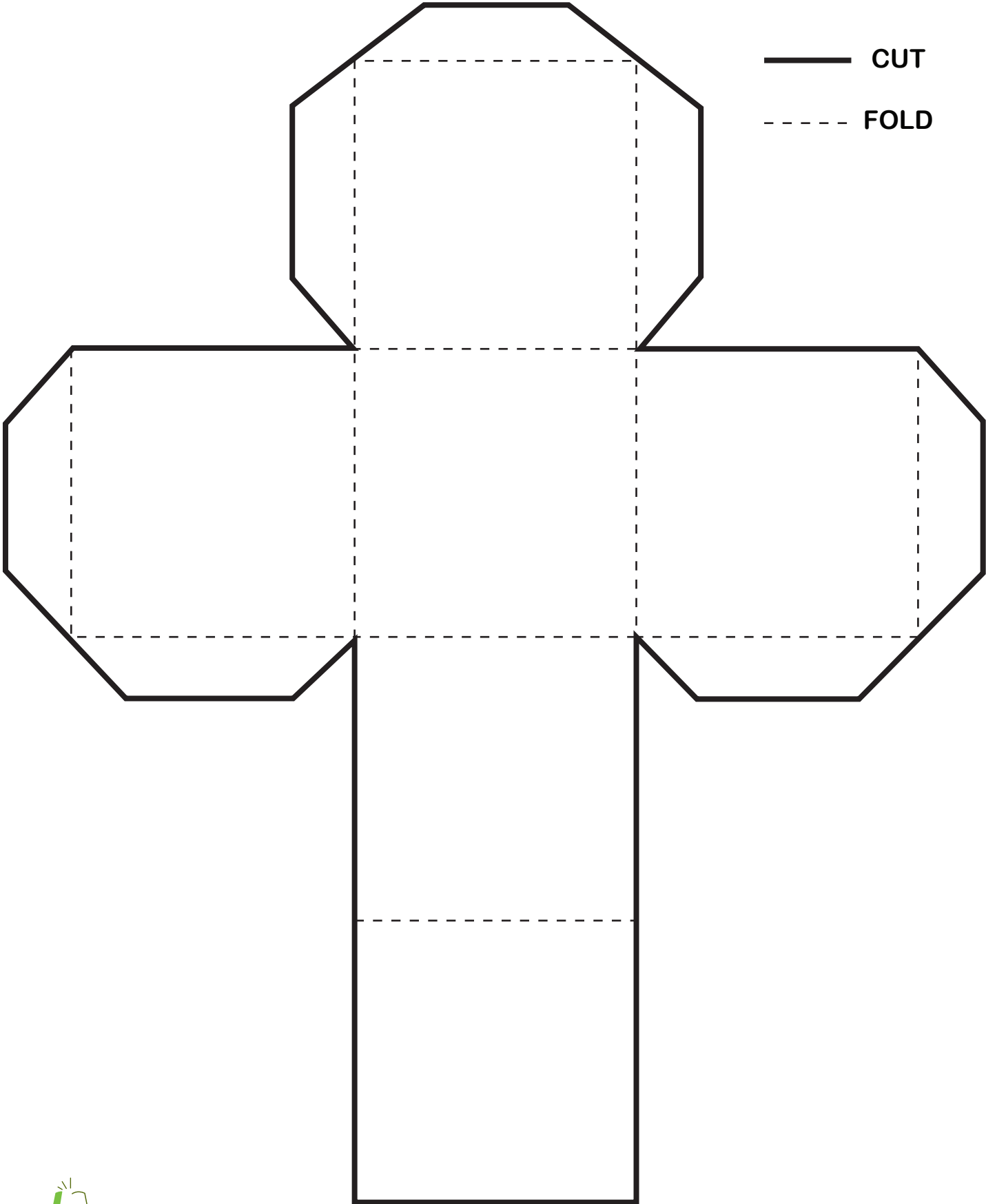

MATH MODELS

TRIANGULAR PRISM

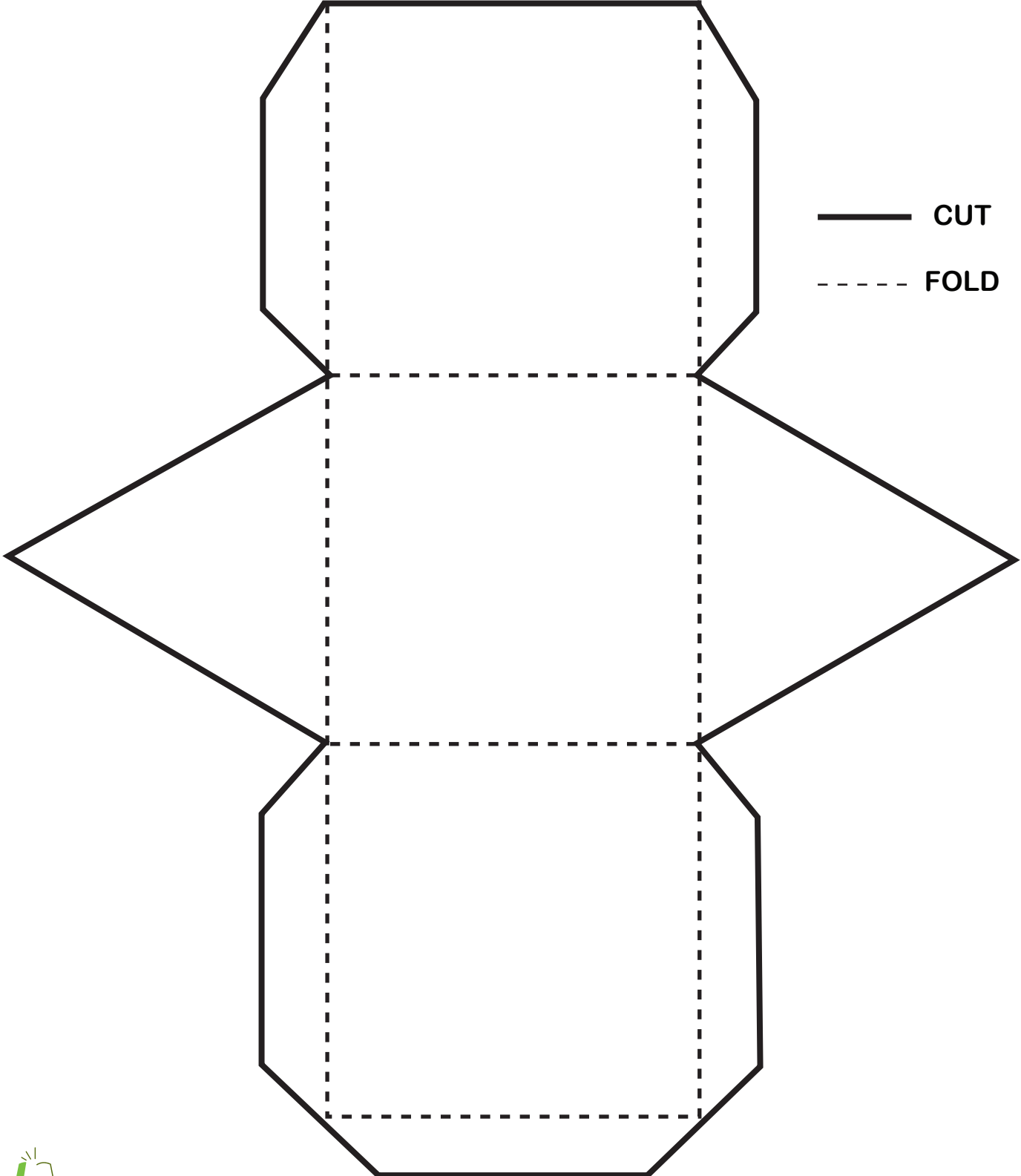

MATH MODELS

RECTANGULAR PRISM

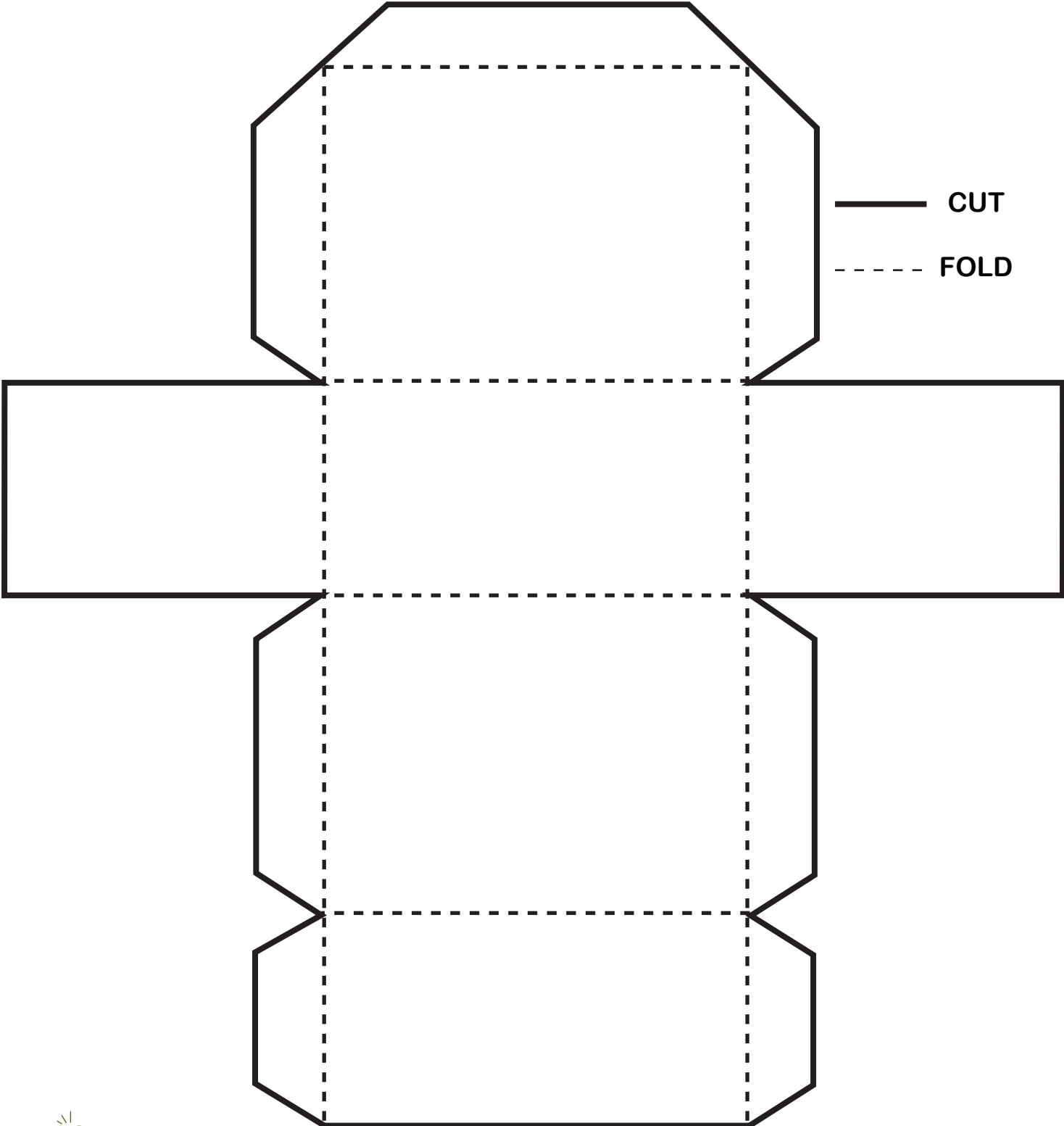

MATH MODELS

TRIANGLE PYRAMID

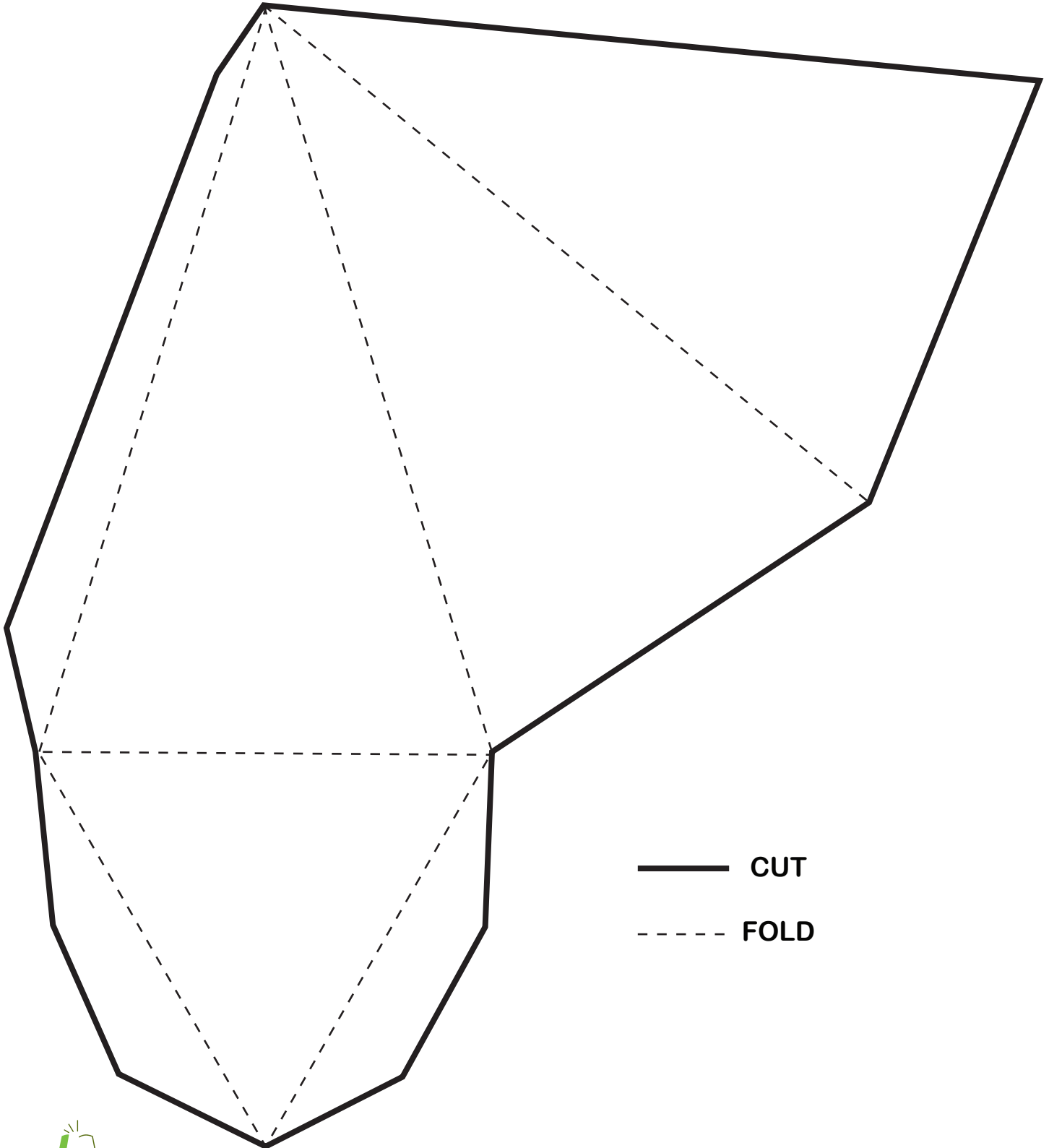

MATH MODELS

PYRAMID

— CUT

- - - FOLD

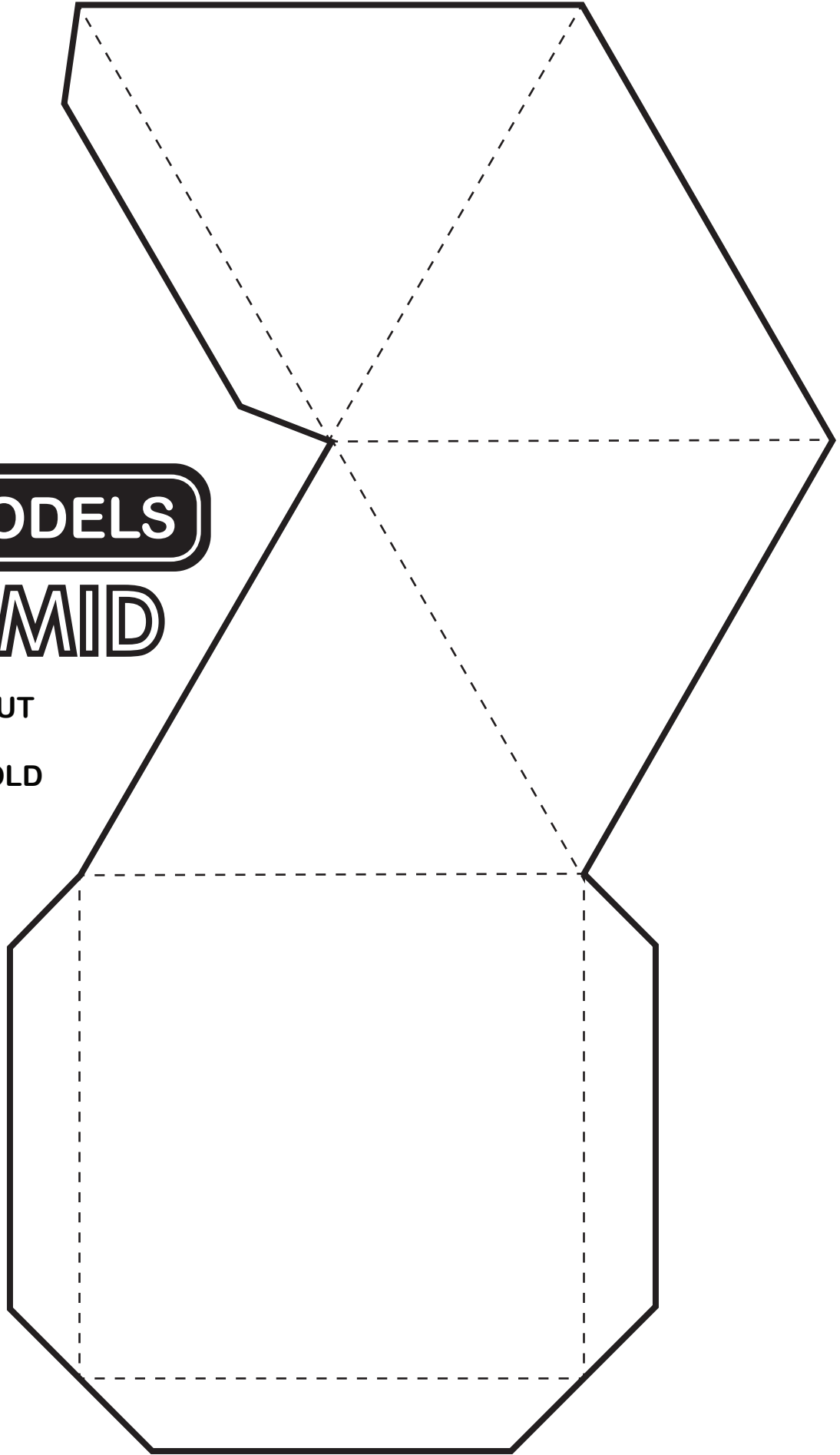

MATH MODELS

CONE

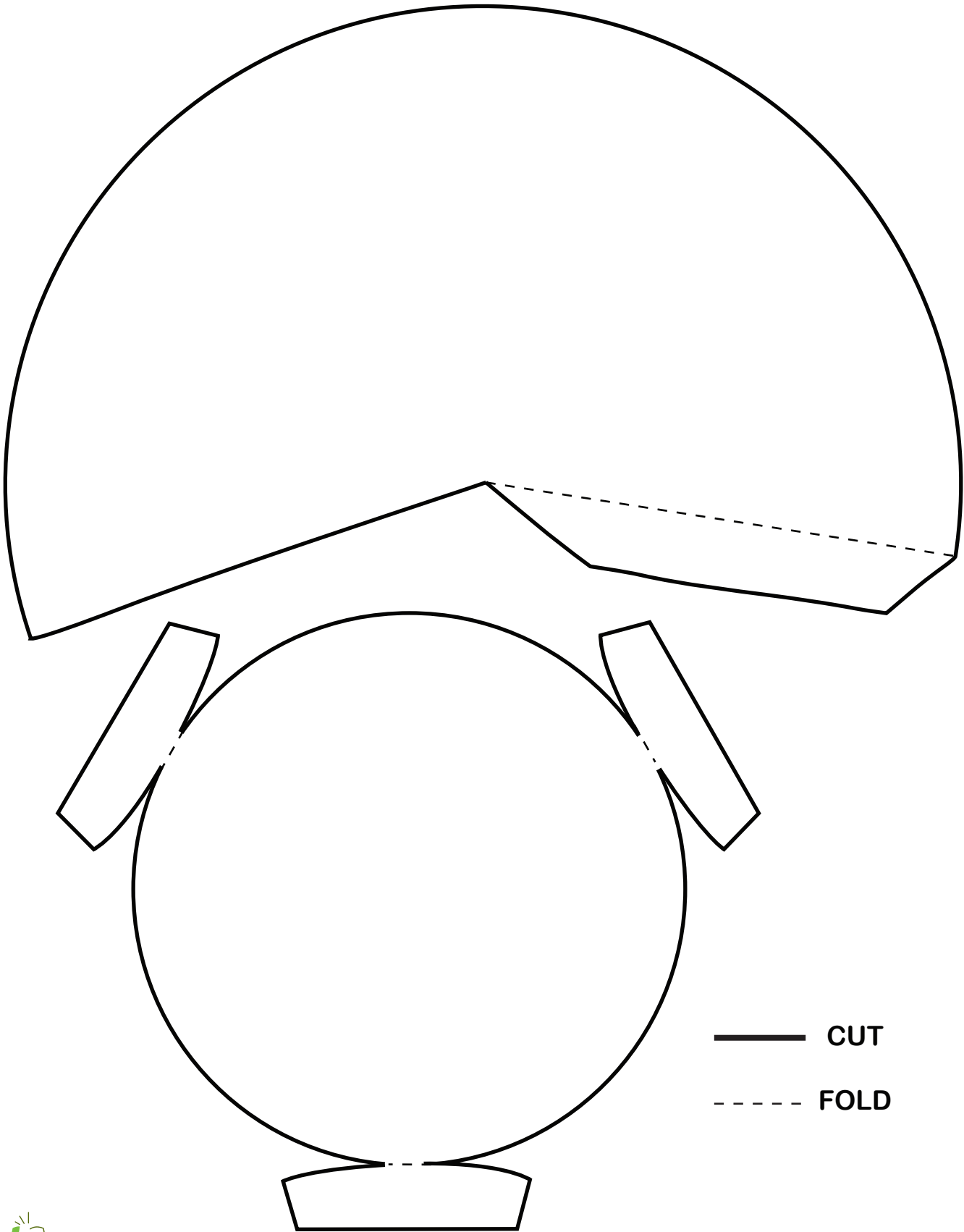

— CUT
- - - FOLD

Let's make some 3-D art! Print the hexagonal prism on the next page. Then follow the instructions below to construct your paper prism.

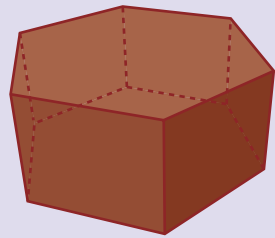

hexagonal prism

1. Color and decorate the shapes in the cut-out.
2. Cut out the entire shape.
3. Fold up along all dotted lines.
4. Glue the flaps to the interior of the shape.

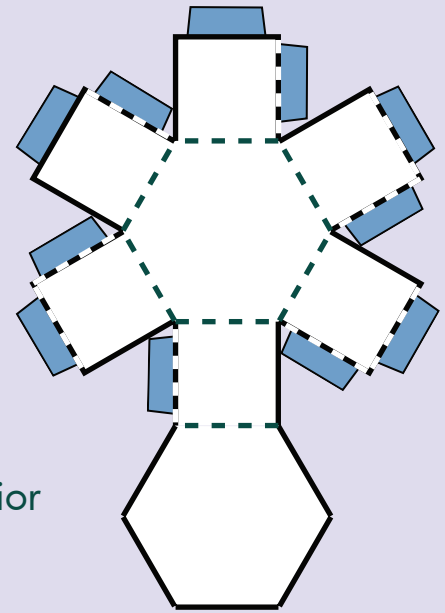

Cut out the pieces below and glue them to your prism to make a silly monster box!

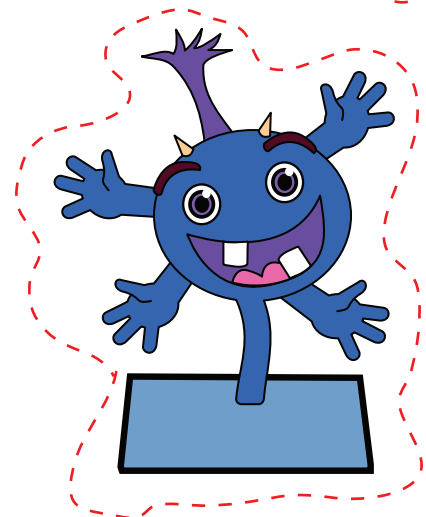
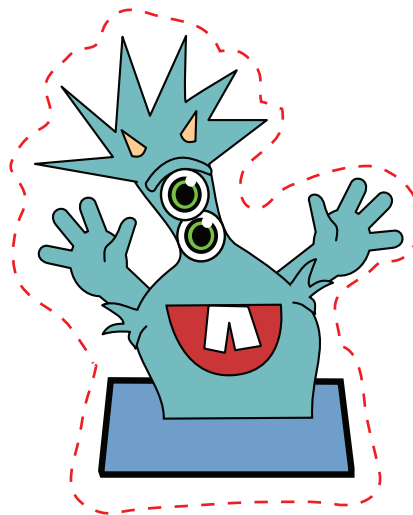
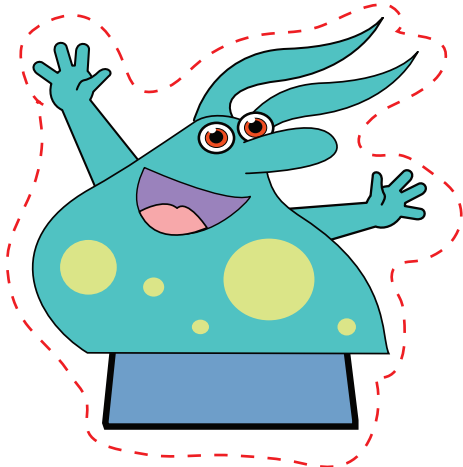
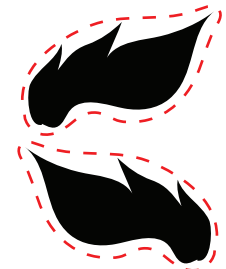
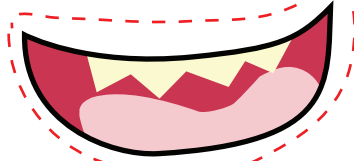
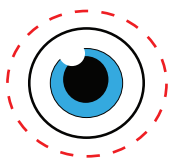
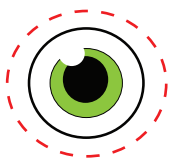
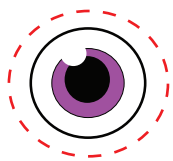

3-D Art

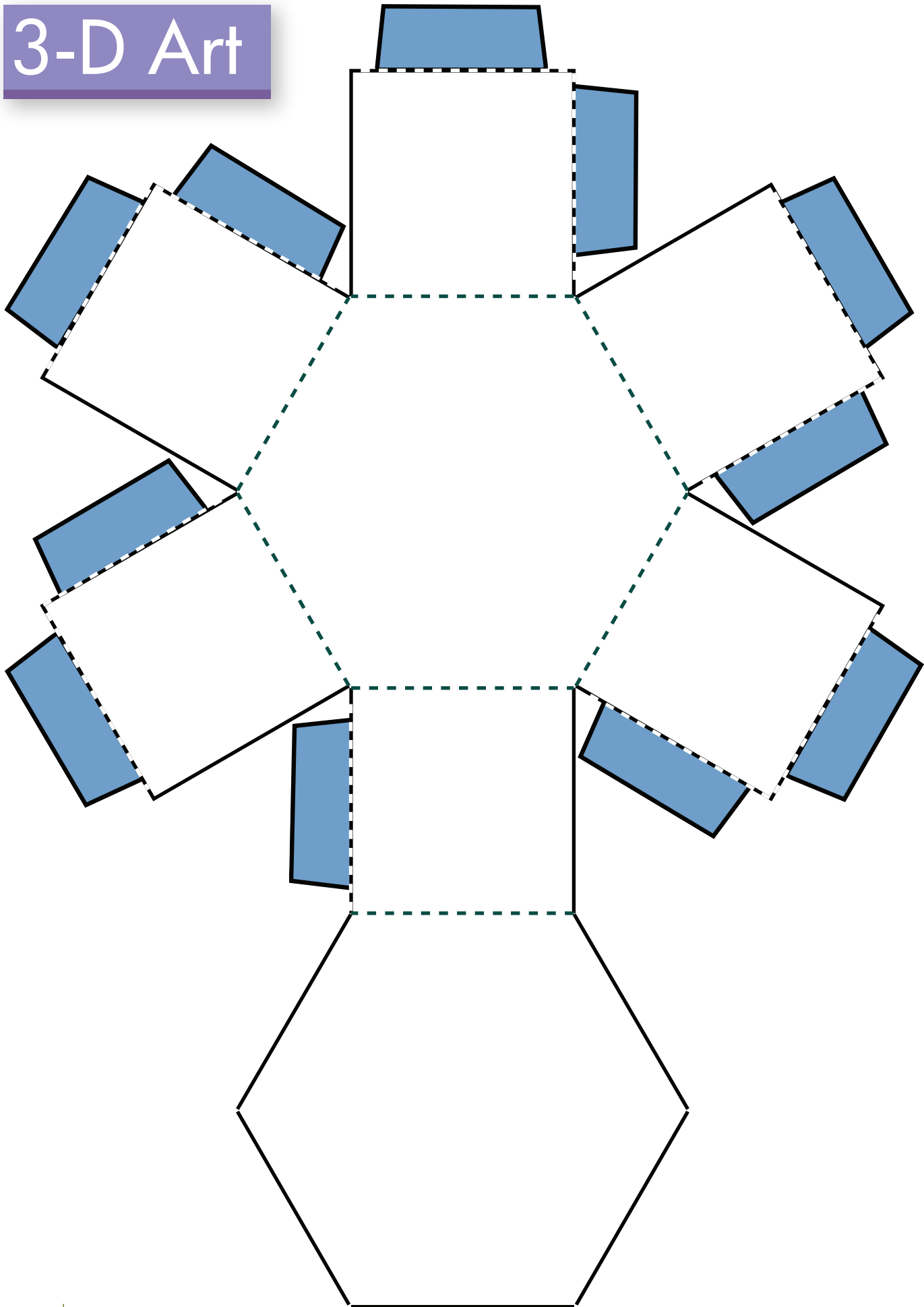

Great job!

is an Education.com math superstar

