

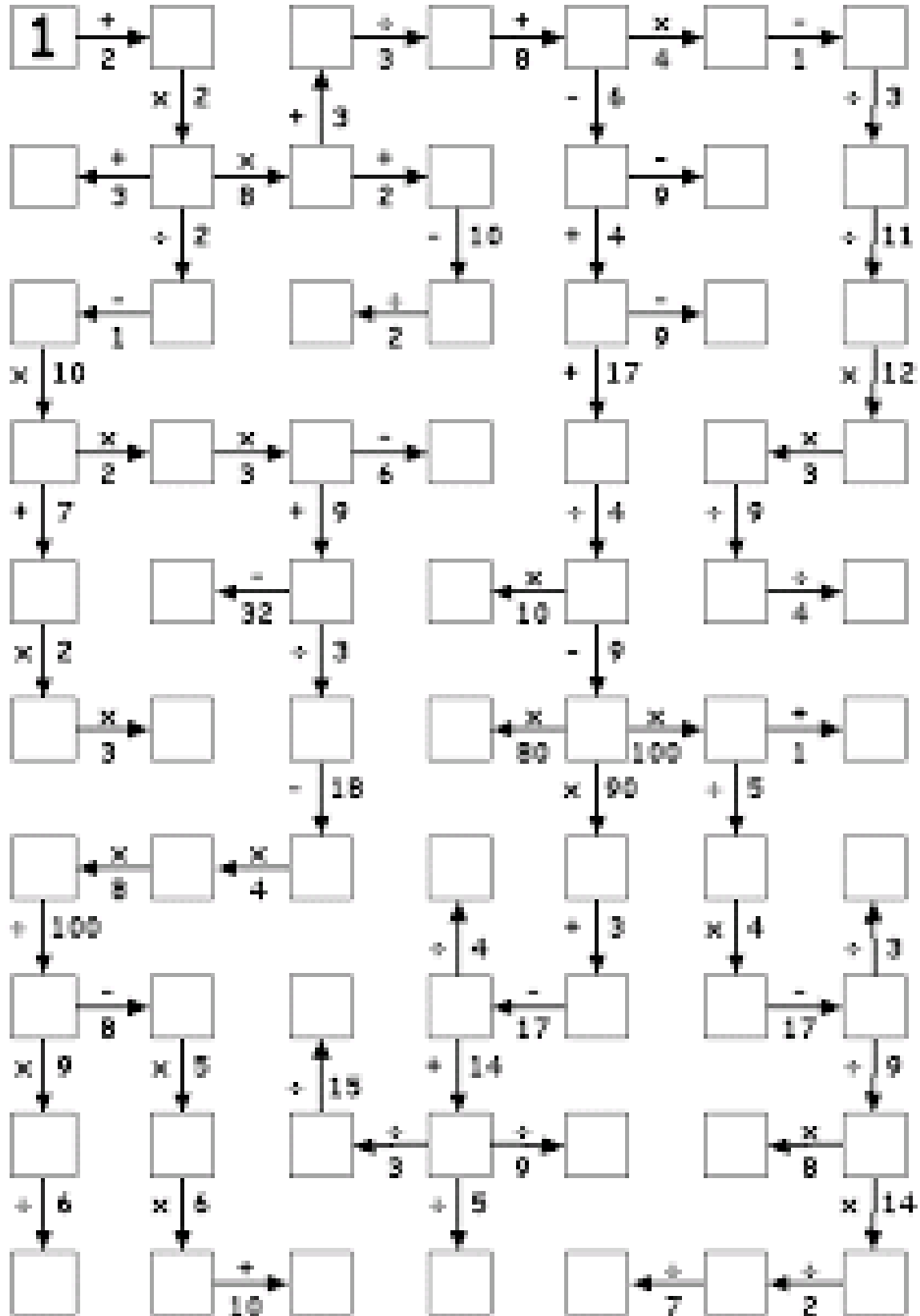











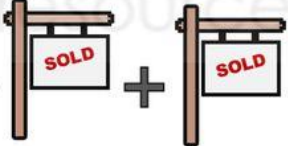









Enigmes mathématiques 1

Number Snake No1

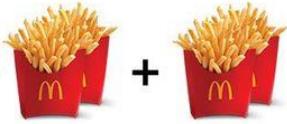

 +  +  = 15
 +  = 13
 +  = 8
 +  ×  = ?

Only for GENiUS #3

 +  +  = 24
 +  = 18
 +  = 13
 +  ×  = 
 who ate my pizza?
 = ?

Facebook.com/PicsDownloadz PicsDownloadz.com