

Name : _____

Score : _____

Teacher : _____

Date : _____

Volume of Pyramids and Cones

Find the volume of each figure. Round answers to the nearest hundredth, if necessary.

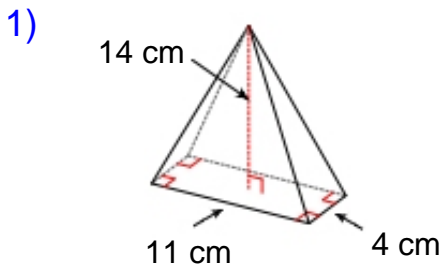

Volume: _____

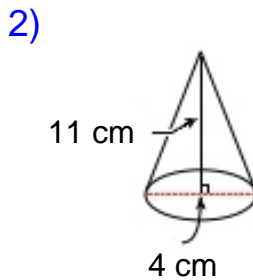

Volume: _____

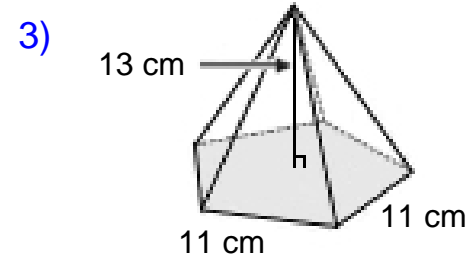

Volume: _____

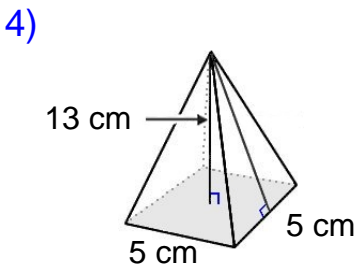

Volume: _____

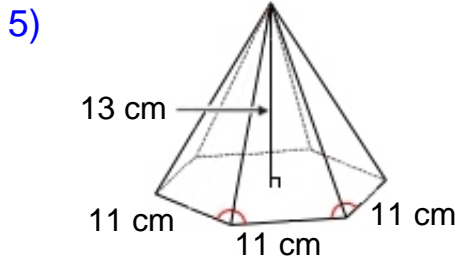

Volume: _____

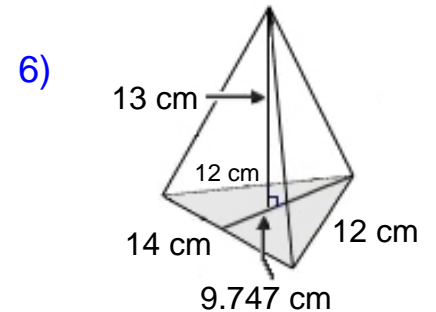

Volume: _____

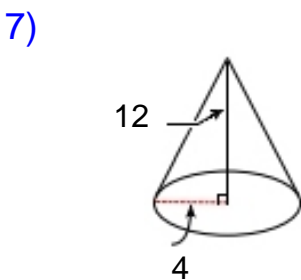

Volume: _____

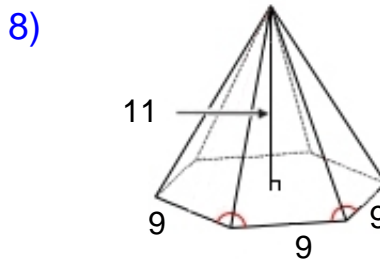

Volume: _____

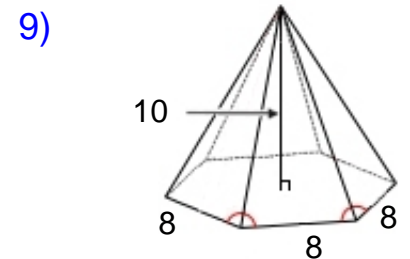

Volume: _____



Name : _____

Score : _____

Teacher : _____

Date : _____

Volume of Pyramids and Cones

Find the volume of each figure. Round answers to the nearest hundredth, if necessary.

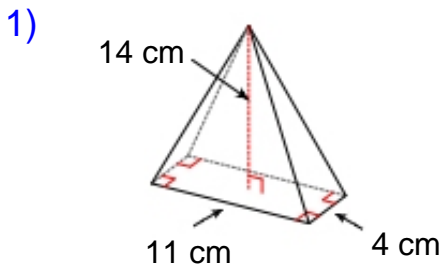

Volume: 205.33 cm³

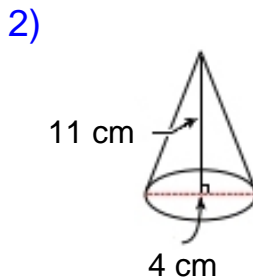

Volume: 46.08 cm³

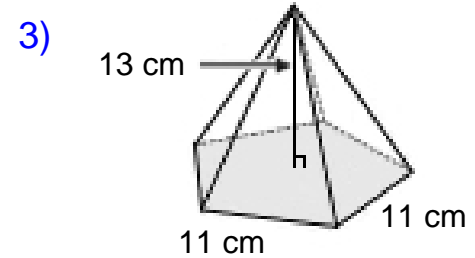

Volume: 902.10 cm³

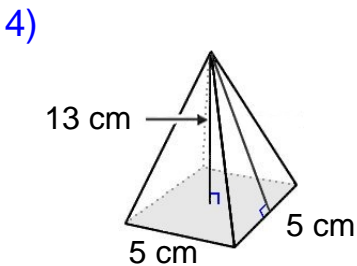

Volume: 108.33 cm³

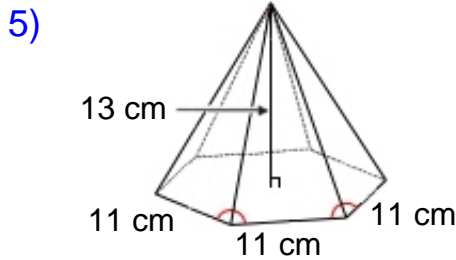

Volume: 1362.26 cm³

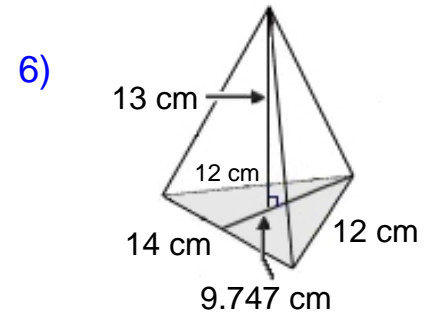

Volume: 295.66 cm³

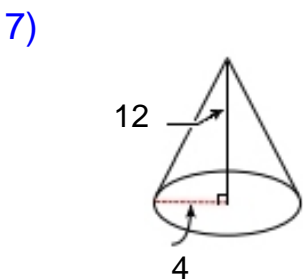

Volume: 201.06³

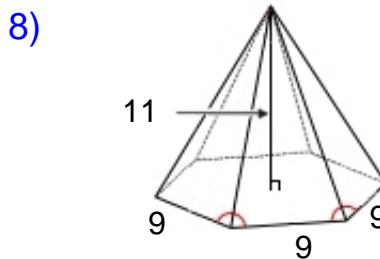

Volume: 771.63³

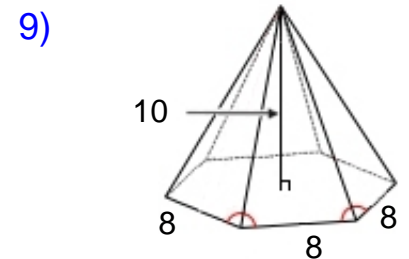

Volume: 554.26³

